

# Air Insulated Switchgear up to 24 kV

**MCset** SF6 withdrawable circuit breaker & **PIX** vacuum withdrawable circuit breaker



Make the most of your energy<sup>SM</sup>

---

# Air Insulated Switchgear (AIS) up to 24 kV

## Contents





---

General **A-1**



---

Schneider Electric AIS ranges **B-1**



---

MCset switchgear -  
SF6 circuit breaker **C-1**



---

PIX switchgear -  
Vacuum circuit breaker **D-1**



---

Protection, monitoring  
and control **E-1**



---

Services **F-1**



# Your requirements

---



RELIABILITY



SIMPLICITY



SAFETY





# Our AIS solutions

Exceptional performance, outstanding reliability, MCset and PIX offer you a comprehensive solution that responds to all your electrical distribution applications - even sensitive applications.



- **Type testing** is carried out for each performance level
- The design, manufacturing and testing are carried out **according to the ISO 9001 and 9002 standards**
- The design is ensured by **advanced computer modeling techniques**

- An **easily understood** user interface. The user is guided through icon-diagrams on each front panel making it easy to understand the operating sequence and device status

- **Interlocks** and **padlocks** preventing operator errors
- **Easy** on-site **control and monitoring**
- Limited and **simple maintenance** for years
- **Easy installation** thanks to compactness and similar design

- Operations and indications are **concentrated on the front** of the switchgear
- Racking in and out is **possible only with the door closed**
- The **voltage present indicator** is located **on the front face** of the functional unit, in the immediate vicinity of the earthing switch control
- **Locking** of withdrawable part/cable compartment
- Locking of the withdrawable compartment door in open position, if the LV plug of the circuit breaker is not plug-in
- The earthing switch has **making capacity**
- **Internal arc withstand** developed for most of the functional units

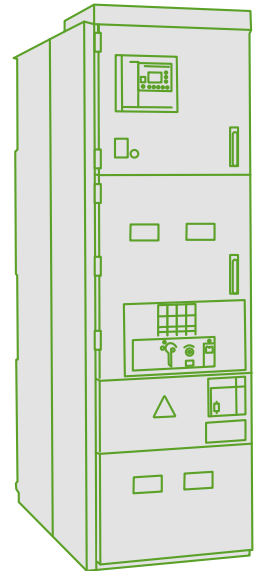

MCset SF6  
withdrawable circuit  
breaker

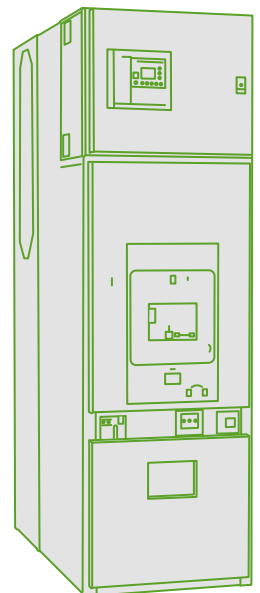

PIX Vacuum  
withdrawable circuit  
breaker

---

Air Insulated Switchgear up to 24 kV  
The strength of experience



---

<b>Scope of applications and some references</b>	<b>A-2</b>
<b>A comprehensive solution</b>	<b>A-4</b>
<b>Schneider Electric Services</b>	<b>A-6</b>
<b>Quality - Environment - Maintenance</b>	<b>A-7</b>

# Scope of application and some references

## Our Air Insulated Switchgear adapts to all electrical power distribution requirements from 1 to 24 kV

The Air Insulated Switchgear is an indoor metal-enclosed device intended for the MV section of HV/MV substations and high power MV/MV substations.

- Air Insulated Switchgear offers you:
  - pre-engineered and adaptable solutions tailored to your specific requirements;
  - significantly reduced maintenance;
  - local support centres throughout the world.
- Air Insulated Switchgear gives you the advantages of:
  - continuity of service for your networks;
  - enhanced safety for your staff and operations;
  - optimised investment throughout the life of your installation;
  - the possibility of integrating your medium voltage switchboard in a monitoring and control system.

## Air Insulated Switchgears are present in all power distribution markets

### Energy

- Electric power stations (thermal, nuclear)
- Auxiliary substations
- Source substations

### Industry

- Oil & gas
- Chemical industry
- Paper mills
- Metallurgy
- Car industry
- Mining
- Cement plants...

### Infrastructure

- Airports
- Ports
- Hospitals
- Water treatment...

### Marine and Navy applications

- Cruisers
- Container ships
- Tankers
- Offshore platforms, fixed and mobile
- LNG (Liquid Natural Gas)
- Navy...

PE569252



### Oil and Gas

In Salah Gas	Algeria (PIX)
Girassol Mpg-Elf	Angola (MCset)
Chevron	Australia / Nigeria (PIX)
Petrobras	Brazil (PIX)
Beijing Huafu	China (PIX)
GDF / Sofregaz	France (PIX)
ONAL	Gabon (MCset)
Tangguh LNG	Indonesia (PIX)
Alya Co	Kazakhstan (MCset)
Tengiz Chevron JV	Kazakhstan (MCset)
Exxon	Nigeria (PIX)
Occidental Mukhaizna LLC	Oman (MCset)
Qatar Petroleum	Qatar (MCset)
Lukoil	Russia (PIX)
Salym Oil Fields	Siberia (PIX)
Repsol, Santander	Spain (MCset)
Syrian Gas Company	Syria (MCset)
Turkmengaz	Turkmenistan (MCset)
Abu Dhabi Oil Refining Company	United Arab Emirates (MCset)
BP	United Kingdom (PIX)
SHELL	United Kingdom / Germany (PIX)
Yemen LNG Company	Yemen (MCset)
Yemgas – Technip	Yemen (MCset)

PE569248



### Infrastructure

Soreti	Belgium (PIX)
Montreal Metro	Canada (PIX)
Shanghai Pudong International Airport	China (PIX)
Beijing International Airport	China (PIX)
Chengdu Metro	China (PIX)
Griebel & Mahncke	Germany (PIX)
Bali International Airport	Indonesia (PIX)
Italian Railways	Italy (MCset)
Ust'Luga Seaport	Russia (PIX)
Alicante airport	Spain (MCset)
Baudirektion Zürich	Switzerland (PIX)
Port of Laem Chabang	Thailand (MCset)
Adnan Menderes Airport	Turkey (PIX)



PE57461



## Marine

Jan de Nul	Belgium (MCset)
Zhen Hua Port Machinery	China (MCset)
Chantiers de l'Atlantique	France (PIX)
FREMM	France (MCset)
Conti Rederei	Germany (MCset)
MSC	Italy (MCset)
M.O.L.	Japan (MCset)
STX Shipyard	Korea (MCset)
CPOC	Malaya (MCset)
Subsea	Norway (MCset)
Sovcomflot	Russia (MCset)
TMT	Taiwan (MCset)
British Gas	United Kingdom (MCset)
Norwegian Cruise Lines	USA (MCset)

PE56253



## Industry

Algérienne des eaux	Algeria (MCset)
Water treatment, Degremont	Argentina (MCset)
Alcoa Aluminium	Australia (MCset)
Croesus Mining	Australia (MCset)
Rolleston Coal Pty LTD	Australia (MCset)
Ciment Karadag	Azerbaijan (MCset)
Volvo	Belgium (MCset)
BAHIA PULP	Brazil (PIX)
CARGILL	Brazil (PIX)
NEOCHIM CHEMICAL	Bulgaria (PIX)
Guangzhou Houde	China (PIX)
Wuhan Iron and Steel	China (PIX)
Cement Lafarge	Equator - Turkey (MCset)
ARCELOR MITTAL	France / Belgium (PIX)
Cement Lafarge	France (MCset)
Peugeot-Citroën	France (PIX)
BMW	Germany (PIX)
Ford	Germany (MCset)
Mercedes	Germany (PIX)
Opel	Germany (PIX)
Porsche	Germany (PIX)
ThyssenKrupp	Germany (PIX)
Wacker Chemie GmbH	Germany (PIX)
AUDI	Hungary (PIX)
Irak Traitement des eaux	Irak
Varvarinskoye Metal Mining Company	Kazakhstan (PIX)
Arab Union Contracting Company	Libya (MCset)
Arcelor	Luxemburg (MCset)
Hydro	Norway (PIX)
Opel	Russia (MCset)
NESMA	Saudi Arabia (PIX)
Thai Pride Cement	Thailand (PIX)
Ciment Bastas	Turkey (MCset)
Corus	United Kingdom (PIX)

PE56579



## Power generation

Sonelgaz	Algeria (MCset)
Moranbah Generation Facility	Australia (MCset)
CPFL	Brazil (PIX)
China Nuclear Power programmes	China (MCset)
Kanshan Thermal Power	China (PIX)
Dewa	Dubai (PIX)
CEA Cadarache	France (MCset)
Enertherm	France (MCset)
EDF	France (PIX)
Wind Turbines	France (MCset)
EON	Germany (PIX)
Vattenfall	Germany (PIX)
PT. PLN (Persero)	Indonesia (PIX)
La Termica	Italy (MCset)
Al Fanar Electrical System	KSA (MCset)
Skagerak Nett AS	Norway (MCset)
KESC	Pakistan (PIX)
Kahramaa	Qatar (PIX)
Zorlu Industrial	Russia (PIX)
Saudi Electricity Company - WOA	Saudi Arabia (PIX)
ESCOM	South Africa (PIX)
Acciona Energia	Spain (PIX)
EWZ Zürich	Switzerland (PIX)
EVN thermal power station	Vietnam (MCset)
Naduong Power	Vietnam (PIX)

PE90010



## Buildings

New Islands Project	Abu Dhabi (MCset)
Hamilton Island	Australia (MCset)
Soreti - European Space Agency	Belgium (PIX)
Nansha district government	China (PIX)
Al Bustan Palace Hotel	Oman (MCset)
King Abdullah University	Saudi Arabia (PIX)
KOLIN Construction Inc.	Turkey (PIX)





## To know and manage, two increasingly essential requirements for all Medium Voltage networks

Faced with demand for an increasing number of energy production sources and the increasingly significant obligations of network adaptability, operators are looking for more flexible, responsive, scalable and simply reconfigurable solutions ("Smart Grids").

It is fundamental for operators to know, understand and act correctly.

- To know the switchboard status at all times.
- To act with full knowledge of the facts.

Our Air Insulated Switchgear provide the most efficient means to control and protect a wide range of applications. Due to the devices they comprise, they can be easily integrated into a monitoring and control system.

### Protection and control relays



Sepam range

#### Sepam

Sepam series 20, series 40, series 60 and series 80 digital protection relays take full advantage of Schneider Electric's experience in electrical network protection.

They provide all the necessary functions:

- Effective fault diagnosis and protection planning
- Accurate measurements and detailed diagnoses
- Integral equipment control
- Local or remote indication and operation

Easy upgrading: addition of communication, digital I/O's, analog output, or temperature acquisition systems can be added due to its modular design.



MiCOM range

#### MiCOM

MiCOM protection provides the user with a choice of cost-optimised solutions for specific protection requirements within the distribution network. The MiCOM relay series offers comprehensive protective function solutions for all power supply systems as well as for various functional and hardware project stages.

### Control relays



GemControl front panel

#### GemControl

Smart switchgear management: a basic unit for control, monitoring, measurement, processing and data transmission.

### PowerMeter and Circuit Monitor metering units



PowerLogic range

The PowerLogic PowerMeter replaces a full complement of basic analog meters. This cost effective, high performance meter provides a full complement of accurate true-rms metering values. The PowerLogic series 3000/4000 Circuit Monitor is designed for critical power users and large energy consumers in order to provide the information needed to confidently enter the evolving world of deregulation. It can be adapted to meter almost any time-of-use or at a real-time.

### Vamp arc flash protection



The arc protection unit detects an arc flash in an installation and trips the feeding breaker. Arc flash protection maximises personnel safety and minimises material damage to the installation in the most hazardous power system fault situations.

### Thermal diagnosis system (only available in the MCset range)



Specially designed for Schneider Electric MV equipment, this system continuously monitors the temperature, using optical fibres and sensors installed at the heart of the sensitive areas. The thermal diagnosis system reduces the probability of failure and reduces maintenance time.

### Monitoring and control

Our Air Insulated Switchgear can be easily:

- Integrated into an existing monitoring and control system: communication between Sepam digital relays and PowerMeter/Circuit Monitor metering devices via a standard protocol (Modbus).
- Integrated into a SMS PowerLogic electrical installation monitoring system.

### Web Remote Monitoring option

Our Air Insulated Switchgear can integrate web technologies so that you can find out information about your electrical installation as easy as opening a Web page. All you need is a standard web browser and a PC connected to your local area network.

### Simple choice

A simple choice between the WRM-1 and WRM-2 service levels allows you to easily monitor your MCset switchboard thanks to your Web Remote Monitoring system. A customised level is also available. Your Web Remote Monitoring MCset switchboard comes equipped with a web server including web pages dedicated to power equipment data.

### Easy commissioning

Web Remote Monitoring equipment is delivered ready to connect and commission. A Quick Start guide, packaged with your switchboard, provides three easy-to-follow steps.

### Functionalities provided

	WRM-1	WRM-2
<b>Instantaneous readings:</b> Displays automatically updated meter values	■	■
<b>Circuit summary:</b> Displays the RMS current 3-phase average (A), the real power (kW), the power factor, the circuit breaker status (if applicable), etc.	■	■
<b>Load current summary:</b> Displays the current RMS value for each phase (A), for all circuits	■	■
<b>Demand current summary:</b> Displays the average demand current value for each phase (A), for all circuits	■	■
<b>Power summary:</b> Displays the present demand (kW), the peak demand (kW) and the times and dates of the records	■	■
<b>Energy summary:</b> Displays the energy (kWh) the reactive energy (kvarh), and the times and dates of the records	■	■
<b>Instantaneous readings of all devices. Basic historical data logging, energy and trending.</b> Displays automatically updated meter values for all of the communicating devices in the system		■
<b>Log displays:</b> Displays data as time curves or tables		■
<b>Export of data tables:</b> Allows data tables to be exported in a standard Windows format		■

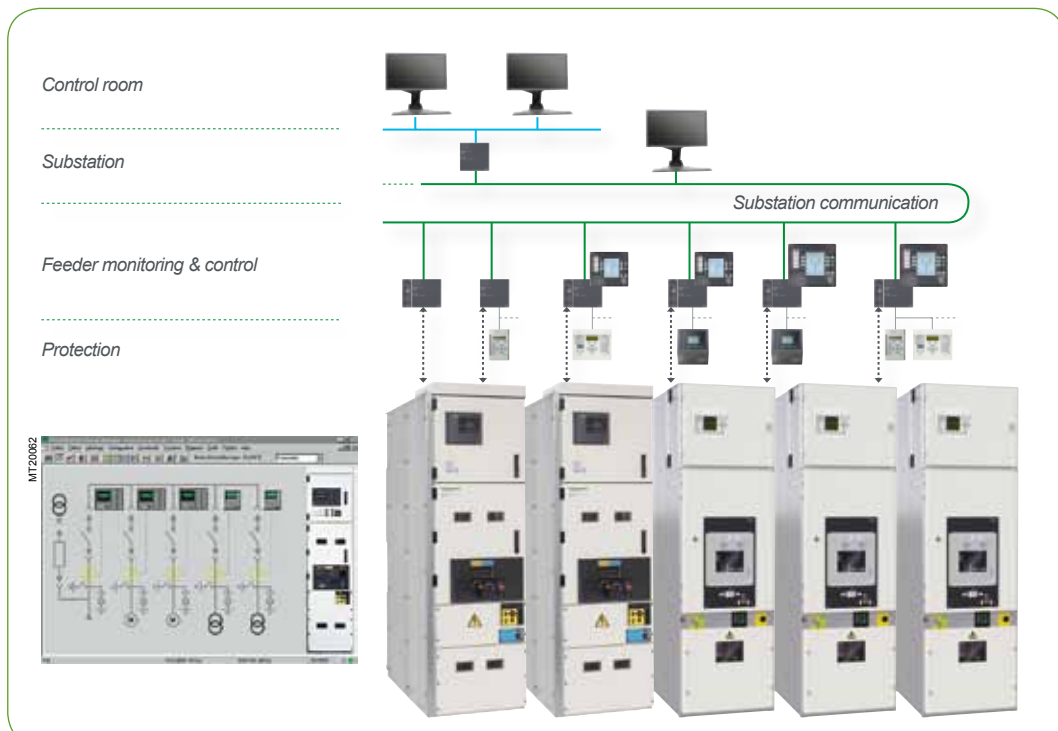
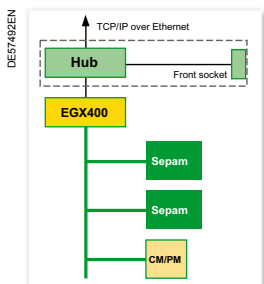

# Schneider Electric Services

## Peace of mind throughout your installation life cycle



### Plan

Schneider Electric helps you to plan the full design and execution of your solution, looking at securing your process and optimising your time:

- **Technical feasibility studies:** Accompany customer to design solution in his given environment.
- **Preliminary design:** Accelerate turn around time to come to a final solution design.

### Install

Schneider Electric will help you to install efficient, reliable and safe solutions based on your plans.

- **Project Management:** Designed to help you complete your projects on time and within budget.
- **Commissioning:** Ensures your actual performance versus design, through on site testing & commissioning, tools & procedures.

### Operate

Schneider Electric helps you maximise your installation uptime and control your capital expenditures through its services offering.

- **Asset Operation Solutions:** The information you need to increase safety, enhance installation training performance, and optimise asset maintenance and investment.
- **Advantage Service Plans:** Customised services plans which cover preventive, predictive and corrective maintenance.
- **On site Maintenance services:** Extensive knowledge and experience in electrical distribution maintenance. For Diagnosis services see on pages from F1 to F3.
- **Spare parts management:** Ensure spare parts availability and optimised maintenance budget of your spare parts.
- **Technical Training:** To build up necessary skills and competencies. in order to properly operate your installations in safety.

### Optimise

Schneider Electric propose recommendations for improved safety, availability, reliability & quality.

- **MP4 Electrical Assessment:** Define improvement & risk management program.

### Renew

Schneider Electric extends the life of your system while providing upgrades. Schneider Electric offers to take full responsibility for the end-of-life processing of old electrical equipments.

- **ECOFIT™:** Keep up to date & improve performances of your electrical installations (LV,MV, Protection Relays...).
- **MV product End of life:** recycle & recover outdated equipment with end of life services.

### Frequency of maintenance intervention

Schneider Electric equipment manufacturers recommend a schedule for maintenance activities to extend Electrical Distribution equipment performance over time. Frequencies under normal/healthy operation (minor equipment criticality and optimal environmental conditions) can be generally defined as follows:

Maintenance	Minimal frequency (1) (every)	Who		
		Manufacturer	Certified Partner	End user
Exclusive	4 years	■		
Advanced	2 years	■	■	
Light	1 years	■	■	■

(1) Recommended under normal operating conditions (minor equipment criticality and optimal environmental conditions). However, this recommended frequency should be increased according to: a) the level of criticality (low, major, critical) b) the severity of environment conditions (i.e. corrosive, naval, offshore) following recommendations of Manufacturer's services.



**When it comes to your electrical distribution installation, we can help you:**

- Increase productivity, reliability, and safety
- Mitigate risk and limit downtime
- Keep equipment up to date and extend lifespan
- Cut cost and increase savings
- Improve your return on investment



**CONTACT US!**

[WWW.schneider-electric/electricaldistributionservices](http://WWW.schneider-electric/electricaldistributionservices)



Certified quality under ISO 9001 and ISO 9002



## A major asset

In each of its business units or manufacturing plants, Schneider Electric integrates a functional organisation whose main role is to check quality and monitor compliance with standards.

This procedure is:

- Uniform throughout all departments
- Recognised by many customers and approved organisations

But above all, its strict application has allowed us to obtain the recognition of an independent organisation as example: The French Quality Assurance Association (AFAQ).

**The quality system for the design and manufacture is certified to be in conformity with the requirements of the ISO 9001: 2008 quality assurance standard.**

## Strict and systematic checks

During manufacture, each functional unit is subject to systematic, routine testing with the aim of checking the quality and conformity of the following features:

- Measurement of the opening and closing speeds
- Measurement of the operating torque
- Dielectric test
- Testing of the safety systems and interlocks
- Testing of the low voltage components
- Conformity with drawings and diagrams

The results obtained are recorded and approved by the quality control department on the test report of each device.

This, therefore, guarantees product traceability.

### ■ Checking SF6 Circuit Breaker

- sealing test
- filling pressure test

## Protected environment

Schneider Electric is committed to a long-term environmental approach.

All necessary measures have been taken in conjunction with our services, suppliers and subcontractors to ensure that the materials used in the composition of the equipment do not contain any substances prohibited by regulations and directives.

In order to help you protect the environment and relieve you of any concerns in terms of stock or dismantling, Schneider Electric Services offers to take back your equipment at the end of its life.

Our Air Insulated Switchgear is designed with environmental protection in mind:

- The materials used, insulators and conductors are identified, easily separable and recyclable
- The SF6 can be recovered at the end of the equipment's life and reused after treatment
- The environmental management system adopted by Schneider Electric's production sites for the manufacture of our Air Insulated Switchgear has been assessed and recognised as conforming to the requirements of the ISO 14001 standard



---

# Air Insulated Switchgear up to 24 kV Schneider Electric AIS ranges







---

<b>AIS ranges</b>	<b>B-2</b>
<b>Operating conditions &amp; Standards</b>	<b>B-4</b>
<b>Specific applications</b>	<b>B-5</b>
<b>Marine application</b>	<b>B-6</b>



# Schneider Electric

For over sixty years, Schneider Electric, leverages its experience to develop vacuum and SF6 circuit breakers and thus holds a unique know-how in various applications of these techniques cut.

Schneider Electric, from the beginning at the outposts of these two complementary technologies, has allowed Research & Development teams, to bring them to their maximum performance.

Thus, based on our long market experience, we can, better than anyone, help objectively and effectively in the selection of the apparatus according to your habits, applications or specific requirements.

## SF6

The dielectric rigidity and the remarkable cut-off characteristics of this gas, put a high value on the SF6 devices worldwide since the middle of the 1950s.

Since then, the progress realized in term of waterproofness and SF6 end of life processing, have again reinforced their credibility.

Schneider Electric switchgears with SF6 withdrawable circuit breakers, are

## MCset

 labelled

# AIS ranges

## Vacuum

From the beginning of the last century, the interruption of current in the vacuum was regarded as an "ideal" technical cut-off.

Nevertheless, several technical difficulties relegated the vacuum technique in the background for nearly three decades, until that numerous innovations from the beginning of the 1960s, gave it its "letters patent of nobility". Schneider Electric switchgears with vacuum withdrawable circuit breakers, are

**PIX** labelled

PE69251



## Operating conditions

Normal operating conditions, according to the IEC International Standards listed below, for indoor switchgear.

- Ambient air temperature:
  - less than or equal to 40°C
  - less than or equal to 35°C on average over 24 hours
  - greater than or equal to - 5°C
- Altitude:
  - less than or equal to 1000 m;
  - above 1000 m, a derating coefficient is applied (please consult us)
- Atmosphere:
  - no dust, smoke or corrosive or inflammable gas and vapor, or salt
- Humidity:
  - average relative humidity over a 24 hour period ≤ 95%
  - average relative humidity over a 1 month period ≤ 90%
  - average vapor pressure over a 24 hour period ≤ 2.2 kPa
  - average vapor pressure over a 1 month period ≤ 1.8 kPa

### Specific operating conditions (please consult us)

MCset and PIX have been developed to meet the following specific conditions:

- High ambient temperature (possible derating)
- Corrosive atmospheres, vibrations, (possible adaptation)

### Storage conditions

In order to retain all of the functional unit's qualities when stored for prolonged periods, we recommend that the equipment is stored in its original packaging, in dry conditions, and sheltered from the sun and rain at a temperature ranging from - 25°C up to + 55°C.

## Standards

The MCset & PIX ranges meet the following international standards:

- **IEC 62271-1**: High-voltage switchgear and controlgear: common specifications
- **IEC 62271-200**: AC metal-enclosed switchgear and controlgear for rated voltages above 1 kV and up to and including 52 kA
- **IEC 62271-100**: High-voltage switchgear and controlgear - Alternating current circuit-breakers
- **IEC 62271-106**: High-voltage switchgear and controlgear - Alternating current contactors, contactor-based controllers and motor-starters
- **IEC 62271-103**: High-voltage switchgear and controlgear - Switches for rated voltages above 1 kV up to and including 52 kV
- **IEC 60282-1**: High-voltage fuses - Current-limiting fuses
- **IEC 62271-102**: High-voltage switchgear and controlgear - Alternating current disconnectors and earthing switches
- **IEC 60255**: Measuring relays and protection equipment - Common requirements
- **IEC 61869-2**: Instrument transformers - Current transformers
- **IEC 61869-3**: Instrument transformers - Inductive voltage transformers
- **IEC 60044-8**: Instrument transformers - Electronic current transformers
- **IEC 62271-105**: High-voltage switchgear and controlgear - Alternating current switch-fuse combinations



## Nuclear

The medium voltage electrical distribution switchgear in a nuclear power station must meet the most stringent requirements. Schneider Electric's more than 30 year experience in this area is at your disposal via our range of Air Insulated Switchgear. Certified by the chief nuclear standards (IEC), our range of Air Insulated Switchgear provides you with:

- Optimised personal safety
- Solidity of electrical and mechanical solutions
- Switchgear that is subjected to various tests, such as:
  - seismic
  - electrodynamic
  - switch-off
- Panel of compact cubicles



## Seismic areas

MCset and PIX 12 meet international seismic specifications. Test procedures follow the IEC 60068-3-3 standard. MCset and PIX 12 meet the requirement of the following documents:

- UBC 97
- IBC 2000
- MSK 64
- ENDESA
- EDF HN.20.E53

## DEP Shell

Our Air Insulated Switchgears are certified by Shell and in compliance with DEP 33.67.51.31 Gen (July 1998 - updated November 2006) for MV equipments

## GOST conformity (MCset till 17.5 kV and PIX 12 kV & 24 kV)

The GOST conformity system applies to most of the products sold and used according to Russian standards. As far as electrical equipment is concerned, this conformity applies when the equipment is used under the following conditions:

- Electrical equipment designed for use in an explosive environment and in mines
- Equipment related to the oil and gas industries: prospecting, exploration, refining, transportation, storage
- Equipment used in the chemical and petrochemical industries and considered to be potentially hazardous because it operates in a toxic, explosive and aggressive environment
- Electrical heating equipment is used to produce ferrous and non-ferrous metal casting

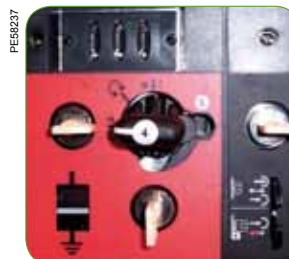

This certification follows the Russian standards:

- GOST 2.601-95
- PB 03-576-03
- PB 03-584-03

The entire Air Insulated Switchgear range meets the GOST certification requirements.



PE60007



PE57452



PE57453



Derived from the standard MCset and PIX, a Marine version has been developed to meet specific conditions when used on ships or offshore platforms (vibrations/impacts, slant, etc.).

This version carries over the electrical and dimensional characteristics of the standard range, adapted to marine requirements:

- PM (partition class) compartmented cubicle (LSC2B type)
- Front access
- Withdrawable circuit breaker
- Sepam protection and control chain
- Internal arc withstand
- Thermal diagnosis (optional)

### Environmental conditions

<b>Ambient temperature</b>		-5 to +45°C
<b>Humidity</b>	On 24 h	95%
	On 1 month	90%
<b>Vibrations (IEC 60068-2-6)</b>	Frequency range	
	2 to 13.2 Hz	1 mm
	13.2 to 100 Hz	0.7 g

### Certifications

MCset Marine	PIX Marine
<b>SF6 circuit breaker and contactor</b>	<b>Vacuum circuit breaker</b>
American Bureau of Shipping (ABS)	
Bureau VERITAS (BV)	Bureau VERITAS (BV)
DNV	
Germanischer Lloyd	
Lloyd's Register	

For other certification please contact us.



Germanischer Lloyd



LR Type Approval Certificate



PE66233



MCset switchboard for Marine

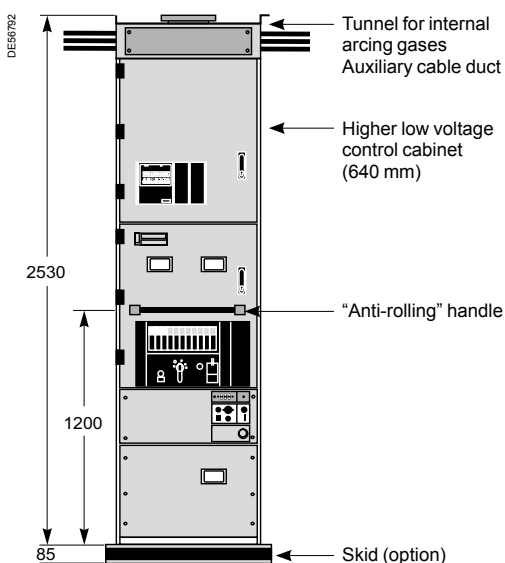

MCset switchgear for Marine

### Suitable for marine requirements

- Internal arcing withstand is ensured by the use of a tunnel specifically designed for marine applications. Located above the cubicle, it can evacuate gases due to arcing effects
- A low voltage control cabinet has also been designed to meet the need for using numerous control and monitoring systems and LV components
- The cubicles are provided with switchgear employing SF6 or vacuum technologies
- The incoming/outgoing feeder cubicles are connected by cables through the bottom
- Skids are available as an option to group together several cubicles on a platform for improved rigidity and to absorb vibrations through the use of dampers. They also facilitate handling and installation of the switchboard.
- Motor starter applications: see Motorpact or PIX MCC catalogues

### MCset and PIX are the solutions to the specific needs and requirements of a Marine environment:

- Performances
  - from 25 to 31.5 kA
  - from 40 to 50 kA <sup>(1)</sup>
  - internal arc withstand 1 s
- Compactness: to meet the space constraints (clearance under ceiling) that are sometimes indispensable, a specific version version can be proposed

#### Rated voltage (kV)

7.2      12      17.5

#### Rated insulation level

Power frequency withstand voltage 50 Hz - 1 min (rms kV)	20	28	38
Lightning impulse withstand voltage 1.2/50 μs (kV peak)	60	75	95

#### Nominal current and maximum short time withstand current <sup>(1)</sup>

##### Functional unit with circuit breaker

Short time withstand current	I <sub>k</sub> max.	(kA/3 s)	31.5 <sup>(4)</sup>	31.5 <sup>(4)</sup>	31.5 <sup>(4)</sup>
Rated current	I <sub>r</sub> CB	(A)	1250	1250	1250
			2500	2500	2500
			3150	3150	3150

##### MCset functional unit with Rollarc fuse-contactor <sup>(2)</sup>

Short time withstand current (prospective value)	I <sub>k</sub> max.	(kA)	50 <sup>(3)</sup>	50 <sup>(3)</sup>	
Rated current	I <sub>r</sub> max.	(A)	250	200	

##### PIX functional unit with CBX fuse-contactor

Short time withstand current (prospective value)	I <sub>k</sub> max.	(kA)	50 <sup>(3)</sup>	50 <sup>(3)</sup>	
Rated current	I <sub>r</sub> max.	(A)	270	195	

#### Internal arc withstand (maximum value) AFLR

(kA/1 s)      31.5 <sup>(4)</sup>      31.5 <sup>(4)</sup>      31.5 <sup>(4)</sup>

<sup>(1)</sup> For functional units equipped with circuit breakers or fuse-contactors, the breaking capacity is equal to the short time withstand current. In all cases, the device peak making capacity is equal to 2.5 times the short time withstand current.

<sup>(2)</sup> Lightning impulse dielectric withstand voltage = 60 kV.

<sup>(3)</sup> Limited by fuses (prospective value).

<sup>(4)</sup> For other performance, please consult us.

PE57468



PE57455



PE57457





---

Air Insulated Switchgear up to 24 kV  
MCset switchgear -  
SF6 circuit breaker





<b>Description</b>	<b>C-2</b>
<b>Technical characteristics</b>	<b>C-3</b>
<b>Functions and characteristics</b>	
Choice of functional units	<b>C-4</b>
AD type cubicles	<b>C-6</b>
RD type cubicles	<b>C-7</b>
CL - GL type cubicles	<b>C-8</b>
TT type cubicles	<b>C-10</b>
DI type cubicles	<b>C-11</b>
Motorpact	<b>C-12</b>
<b>Switchgear / Apparatus</b>	
MCset design	<b>C-16</b>
LF circuit breaker	<b>C-18</b>
SF circuit breaker	<b>C-24</b>
Rollarc contactor	<b>C-26</b>
DI switch cubicle	<b>C-29</b>
<b>Installation</b>	
Accessories and extraction withdrawable parts	<b>C-32</b>
Implementation examples	<b>C-33</b>
Connections	<b>C-36</b>
<b>Cubicle equipment</b>	<b>C-38</b>

## Structure of an MCset switchboard

MCset switchboards are made up of several interconnected functional units.

The power connections are made between the functional units within a switchboard via a single busbar.

The electrical continuity of all of the metal frames is provided by the connection of each functional unit's earthing busbar to the switchboard's main earthing circuit.

Low voltage wiring trays are provided in the switchboard above the low voltage control cabinets.

Low voltage cables can enter the switchboard through the top or bottom of each functional unit.

## Description of a functional unit

A functional unit consists of all of the equipment in the main and auxiliary circuits which together provide a protection function. Each functional unit combines all of the components which are required to fulfil this function:

- The cubicle, and
- The protection, monitoring and control system (including the withdrawable live part).

## Accessibility of the MV compartments

### Interlock-controlled accessible compartment:

- Withdrawable MV part (circuit breaker, contactor) compartment for AD/RHC/RHB/CL units.

### Tool-based accessible compartments:

- Cable compartment, main busbar for the AD/RHC/ CL/GL/DI units
- Busbar compartment for the RHB
- Bottom busbar compartment for the CL/GL units
- Fixed bridge compartment for the GL unit

## The protection, monitoring and control system

This includes:

- The Sepam, MiCOM, protection, monitoring and control unit
- The GemControl monitoring and control unit
- The Vamp arc flash protection system
- Current sensors, which may be of 4 types,
  - a conventional current transformer Current Transformer
  - toroid type Current Transformers
  - LPCT type Current Transformers
  - CSP type broad-range Current Transformers (for MCset 17.5 kV)
- Voltage Transformers, and
- Zero sequence core balance Current Transformers (CSH type)

## The cubicle

The cubicle is a LSC2B (Loss of Service Continuity Category) type as defined by IEC standard 62271-200; in other words, the medium voltage parts are compartmented using metal partitions (PM class) that are connected to earth and which separate:

- The busbars
- The withdrawable part (circuit-breaker, fuse-contactor, disconnecter truck or earthing truck), and
- The MV connections, earthing switch, current sensors and Voltage Transformers, as required

MCset guarantees a high level of protection of people; when an accessible compartment is open, the other compartments and/or functional units may remain energised.

The low voltage auxiliaries and monitoring unit are in a control cabinet separate from the medium voltage section.

### Five basic cubicle layouts are offered:

- Incomer or feeder **AD**
- Direct Incomer **RD** (for 24 kV)
- Line-up bussection **CL - GL**
- Busbar metering and earthing **TT**
- Fuse-switch feeder **DI**

## The withdrawable part

The withdrawable function gives the ability to disconnect devices.

It includes:

- The circuit breaker, contactor, or the earthing truck,
- The propulsion mechanism for racking in and racking out, and
- Interlocks to fix the withdrawable part, either in a service or disconnecting position

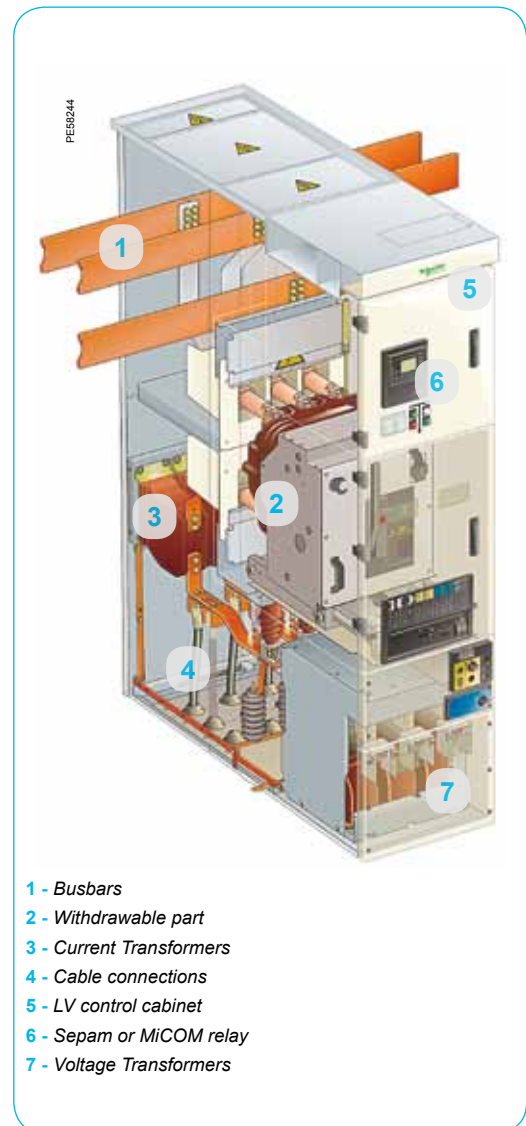

- 1 - Busbars
- 2 - Withdrawable part
- 3 - Current Transformers
- 4 - Cable connections
- 5 - LV control cabinet
- 6 - Sepam or MiCOM relay
- 7 - Voltage Transformers



### LSC2B

(Loss of Service Continuity IEC 62271-200):

this category defines the possibility of keeping other compartments energised (in service) when opening a main circuit compartment.



PE66232



The values below are given for the normal operating conditions as defined in IEC 62271-200 and 62271-1.

Rated voltage						
Ur (kV)		7.2	12	17.5	24	
Rated insulation level						
Power frequency withstand voltage 50 Hz - 1 min	Ud (rms kV)	20	28	38	50	
Lightning impulse withstand voltage 1.2/50 µs	Up (kV peak)	60	75	95	125	
Rated normal current and maximum short time withstand current (1)						
Functional unit with circuit breaker						
Short time withstand current	Ik max. (kA/3 s)	25	25	25	16	
		31.5	31.5	31.5	25	
		40	40	40	31.5	
		50 (6)	50 (6)			
Rated current	Ir max. busbar (A)	4000	4000	4000	2500 (7)	
Rated current	Ir CB (A)	1250	1250	1250	630	
		2500	2500	2500	1250	
		3150	3150	3150	2500	
		4000 (2)	4000 (2)	4000 (2)		
Functional unit with fuse-contactor (3)						
Short time withstand current (prospective value) (9)	Ik max. (kA)	50 (4)	50 (4) (5)			
Rated current	Ir max. (A)	250	200 (5)			
Functional unit with switch-fuse combination (DI cubicle) (8)						
Rated current according to the fuses installed, see documentation						
Rated current	Ir max. ≤ (A)	200	200	200	200	
Internal arc classification (maximum value I <sub>A</sub> and t <sub>A</sub> )						
		(kA/1 s)	50	50	50	25
		(kA/0.15 s)				31.5
Degree of protection						
		IP3X			IP3X	
		IP4X (7)			IP4X	
		IPX2			IPX1 (7)	



**IAC (internal arc classification):**

The metal enclosed switchgear may have different types of accessibility on the various sides of its enclosure.

For identification purposes concerning the different sides of the enclosure, the following code shall be used (according to the IEC 62271-200 standard):

- A: restricted access to authorised personnel only
- F: access to the front side
- L: access to the lateral side
- R: access to the rear side.

(1) For functional units equipped with circuit breakers or fuse-contacts, the breaking capacity is equal to the short time withstand current. In all cases, the device peak making capacity is equal to 2.5 times the short time withstand current.

(2) With fan.

(3) Lightning impulse dielectric withstand voltage = 60 kV peak.

(4) Limited by fuses (prospective value).

(5) With Rollarc contactor.

(6) Limited to 1 s for In circuit breaker: 1250 A.

(7) For higher performance, consult us.

(8) According to IEC 62271-105, combinations do not have a rated short time withstand current.

(9) In accordance with IEC 62271-106.

# Functions and characteristics

## Choice of functional units

MCset has a comprehensive range of functions to suit all requirements for many applications.

The table below can be used to link requirements to functional units and gives basic information on the general composition of each unit.

**Selection guide:**

You want to supply power to a transformer.

The chosen solution is a **transformer feeder/breaker**.

The corresponding functional unit will therefore be a **TF-B**, containing a **AD cubicle** equipped with a withdrawable **circuit breaker**, and a **transformer application**.

The main functions of the equipment are shown below.

Additional functions are available upon request to answer specific requirements.

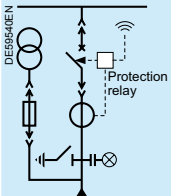
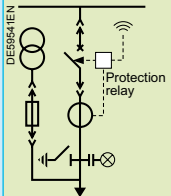
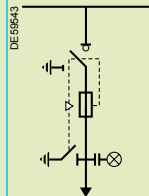
Function	Incomer (1)			Feeder			
	Line	Transformer	Generator	Line	Transformer	Transformer	
Functional unit	LI-B	TI-B	GI-B	LF-B	TF-B	TF-S	
Cubicle	AD1-2-3-4	AD1-2-3-4	AD1-2-3-4	AD1-2-3-4	AD1-2-3-4	DI 2 - DI 4	
Device	Circuit breaker	Circuit breaker	Circuit breaker	Circuit breaker	Circuit breaker	Fuse-switch	
Protection relay							
Applications	Substation	Transformer	Generator	Substation	Transformer	Transformer	
Single line diagrams							

(1) The direct incomer (functional unit without circuit breaker, equipped with a fixed busbar bridge) is produced using cubicles AD1-2-3 for U up to 17.5 kV. For the 24 kV version, the direct incomer is produced using a specific cubicle: RD4.

(2) Transition cubicle for MCC application (Motorpact).



Feeder				Bussectioning		Metering and busbar earthing	Motorpact transition (2)
Motor	Motor	Capacitor	Capacitor	Switchboard	Substation		Motor control
<b>MF-B</b>	<b>MF-C</b>	<b>CB-B</b>	<b>CB-C</b>	<b>BS-B</b>	<b>SS-B</b>	<b>BB-V</b>	
AD1-2-3-4	AD1C	AD1-2-3-4	AD1C	CL1-2-3-4 and GL1-2-3-4	AD1-2-3-4	TT1-2-4	
Circuit breaker	Fuse contactor	Circuit breaker	Fuse contactor	Circuit breaker	Circuit breaker		
Motor	Motor	Capacitor	Capacitor	Busbar	Substation		
<p>DE59941EN</p>	<p>DE59942EN</p>	<p>DE59941EN</p>	<p>DE59942EN</p>	<p>DE59944EN</p>	<p>DE59944EN</p>	<p>DE59946</p>	<p>DE60167</p>



# Functions and characteristics

## AD type cubicles

### Incomer or feeder

#### MV devices

- 1 Busbars for cubicle interconnection
- 2 Main switching device
- 3 MV connections by cables accessible from the front face
- 4 Earthing switch
- 5 Current sensors
- 6 Voltage Transformers (optionally equipped with withdrawable fuses)

#### LV control cabinet

- 7 Low voltage auxiliaries and the protection, monitoring and control unit are in a control cabinet which is separated from the medium voltage part

#### AD1, AD2, AD3

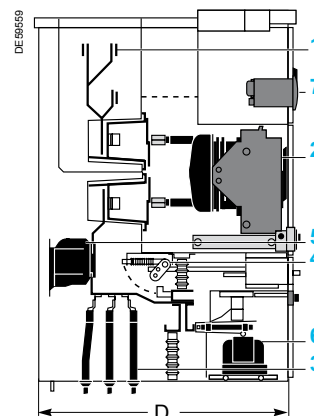
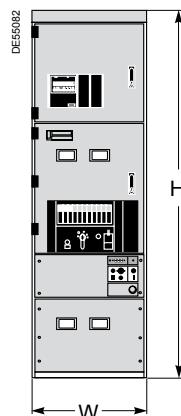
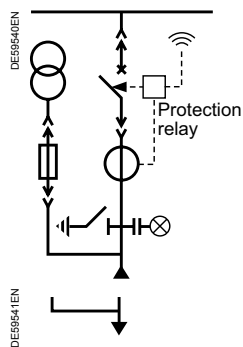

#### AD4

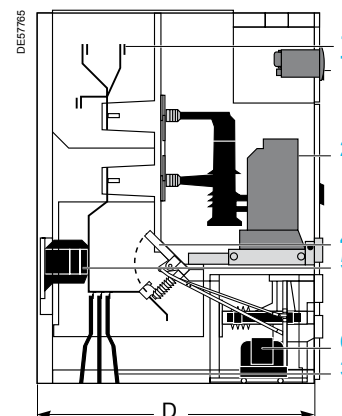
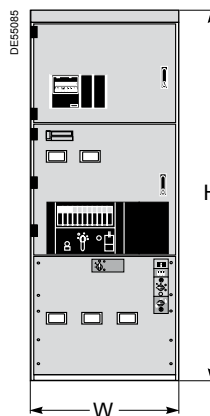
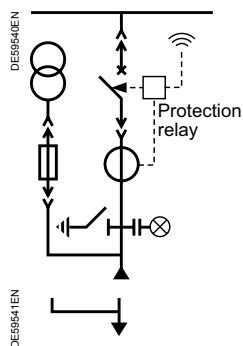

### Characteristics

	AD1						AD2						AD3						AD4					
<b>Rated voltage (kV)</b>	7.2 12						7.2 12 17.5						7.2 12 17.5						24					
<b>Breaking capacity (kA)</b>	25	31.5	50 <sup>(1)</sup>	25	31.5	50 <sup>(1)</sup>	40	50	40	25	31.5	25	31.5	40	50	25	31.5	40	50	25	31.5	40	50	31.5
<b>Rated current (A) SF6 type switchgear</b>																								
SF6 circuit breaker	630	■	■	■	■	■	■	■	■	■	■	■	■	■	■	■	■	■	■	■	■	■	■	■
	1250	■	■	■	■	■	■	■	■	■	■	■	■	■	■	■	■	■	■	■	■	■	■	
	2500											■	■	■	■	■	■	■	■	■	■	■	■	
	3150											■	■	■	■	■	■	■	■	■	■	■	■	
	4000 <sup>(3)</sup>														■								■	
Rollarc contactor	200		■			■																		
	250		■																					
Short-circuit making current I <sub>p</sub> (peak value kA)	50 Hz	63	79		63	79						63	79	100	125	63	79	100	125	63	79	100	125	79
	60 Hz <sup>(5)</sup>																							
Dimensions (mm)	H	2300						2300						2300						2325				
	W	570						700						900						900				
	D <sup>(2)</sup>	1550						1550						1550						1750				
Approximate mass (kg) <sup>(4)</sup>	850 / 600						1000 / 800						1300 / 900						1100					

(1) Fault current limited by fuses: prospective current value in accordance with IEC 62271-106.

(2) Overall + 175 mm for 4-sided internal arcing protected switchboards, for 3150 A, for 4000 A or 2 sets of CT's.

(3) With fan.

(4) Fully equipped cubicle.

(5) Consult us for 60 Hz.



#### MV devices

- 1 Busbars for cubicle interconnection
- 3 MV connections by cables accessible from the front face
- 4 Earthing switch
- 5 Current sensors

#### LV control cabinet

- 7 Low voltage auxiliaries and the protection, monitoring and control unit are in a control cabinet which is separated from the medium voltage part

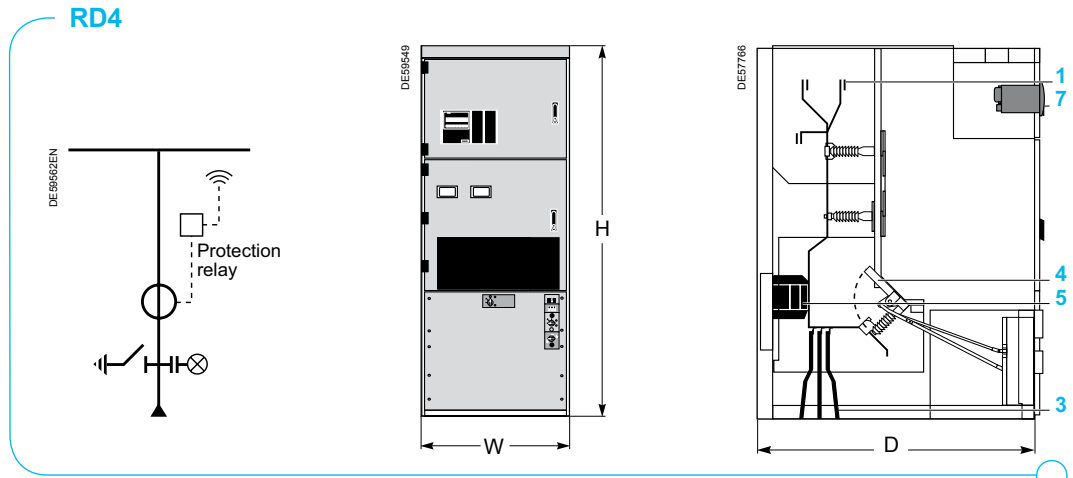

### Characteristics

			RD4
Rated voltage	kV		24
Breaking capacity	kA		—
Rated current	A	630	■
		1250	■
		2500	■
Short-circuit making current $I_p$	kA peak	50 Hz	79
		60 Hz (5)	
Dimensions (mm)	mm	Height (H)	2325
		Width (W)	900
		Depth (D) (2)	1750
Approximate mass (4)	kg		930

(2) Overall + 175 mm for 4-sided internal arcing protected switchboards, for 2 sets of CT's.

(4) Fully equipped cubicle.

(5) Consult us for 60 Hz.

# Functions and characteristics

## CL - GL type cubicles

### Line-up bussectioning

The bussectioning functional unit comprises 2 cubicles mounted side by side (one cubicle equipped with a circuit breaker, the other with a busbar return).

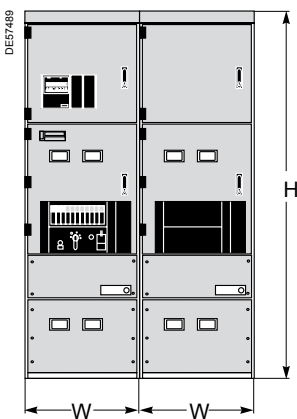
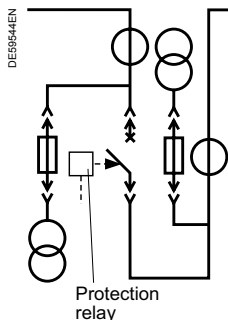

#### MV devices

- 1 Busbars to connect the bussectioning functional unit with other switchboard functional units
- 2 Main switching device
- 3 Current sensors
- 4 Voltage Transformers (optionally equipped with withdrawable fuses)

#### LV control cabinet

- 5 Low voltage auxiliaries and protection, monitoring and control unit are in one control cabinet, separated from the medium voltage part

#### CL1, CL2, CL3

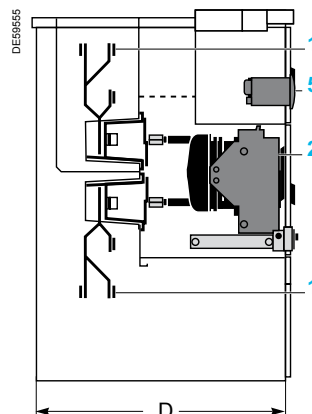

#### GL1, GL2, GL3

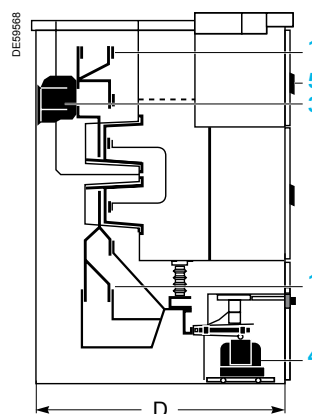

### Characteristics

		CL1-GL1				CL2-GL2				CL3-GL3											
Rated voltage (kV)		7.2	12	17.5	25	7.2	12	17.5	25	7.2	12	17.5	25	12	17.5	25	31.5	40	50		
Breaking capacity (kA)		25	31.5	40	50	25	31.5	40	50	25	31.5	40	50	25	31.5	40	50	63	80		
Rated current (A) SF6 type switchgear		630	1250	2500	3150	4000 <sup>(3)</sup>	630	1250	2500	3150	4000 <sup>(3)</sup>	630	1250	2500	3150	4000 <sup>(3)</sup>	630	1250	2500	3150	4000 <sup>(3)</sup>
Short-circuit making current I <sub>p</sub> (peak value kA)	50 Hz	63	79	100	125	160	63	79	100	125	160	63	79	100	125	160	63	79	100	125	160
	60 Hz <sup>(5)</sup>																				
Dimensions (mm)	H	2300				2300				2300											
	W	570 (x 2)				700 (x 2)				900 (x 2)											
	D (2)	1550				1550				1550											
Approximate mass (kg) (4)		1300 (CL1 + GL1)				1500 (CL2 + GL2)				1700 (CL3 + GL3)											

(2) Overall + 175 mm for 4-sided internal arcing protected switchboards, for 3150 A, for 4000 A or 2 sets of CT's.

(3) With fan.

(4) Fully equipped cubicle.

(5) Consult us for 60 Hz.

The bussectioning functional unit consists of 2 cubicles mounted side by side (one cubicle equipped with a circuit breaker, the other with a busbar return).

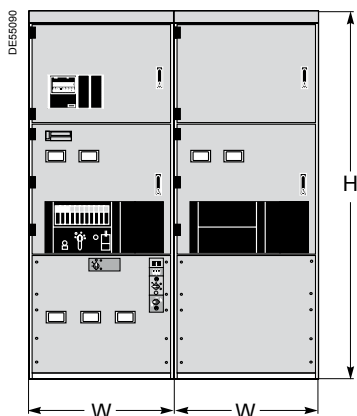
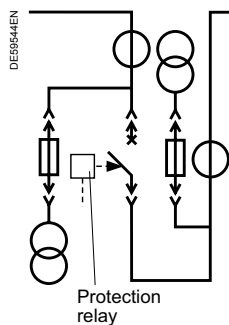

### MV devices

- 1 Busbars to connect the bussectioning functional unit with other switchboard functional units
- 2 Main switching device (circuit breaker SF1-2, disconnecter truck or earthing truck)
- 3 Current sensors
- 4 Voltage Transformers (optionally equipped with withdrawable fuses)

### LV control cabinet

- 5 Low voltage auxiliaries and protection, monitoring and control unit are in one control cabinet, separated from the medium voltage part

### CL4

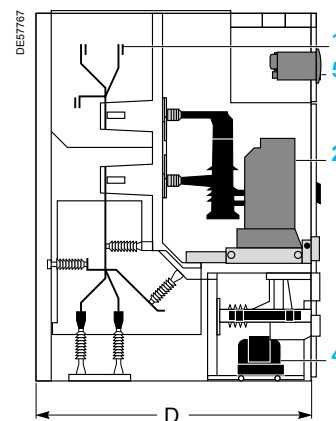

### GL4

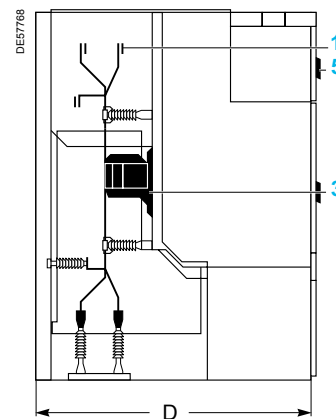

## Characteristics

			CL4 - GL4
Rated voltage	kV		24
Breaking capacity	kA		31, 25
<b>Rated current (A) SF6 type switchgear</b>			
SF6 circuit breaker	630		■
	1250		■
	2500		■
Rated insulation level	kV power frequency 50 Hz - 1 min		50
	kV lightning impulse 1.2/50 μs		125
Short time withstand current	kA rms 3 s		16, 25
Dimensions	mm	Height (H)	2325
		Width (W)	900 (x 2)
		Depth (D) (1) (2)	1750
Approximate mass (3)	kg		1600 (CL4 + GL4)

(1) Overall + 175 mm for 4-sided internal arcing protected switchboards.

(2) Overall + 500 mm for upstream CTs.

(3) Fully equipped cubicle.

# Functions and characteristics

## TT type cubicles

### Metering - Busbar earthing

#### MV devices

**1** Busbars to connect the TT functional unit with other switchboard cubicles

**2** Earthing switch

**3** Voltage Transformers (optionally equipped with withdrawable fuses)

#### LV control cabinet

**4** Low voltage auxiliaries and the protection, monitoring and control unit are in a control cabinet which is separated from the medium voltage part

#### TT1-2

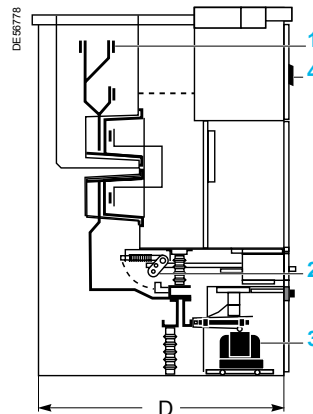
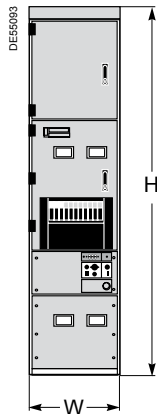
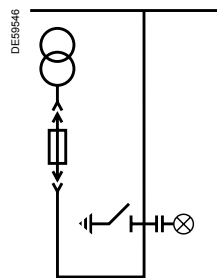

#### TT4

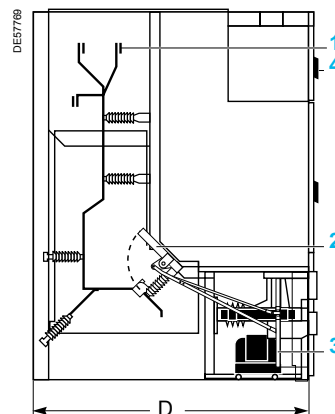
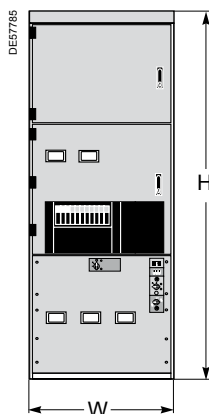
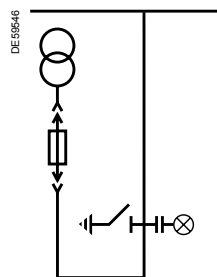

### Characteristics

		TT1		TT2				TT4
<b>Rated voltage</b>	kV	7.2	12	7.2	12	17,5		24
<b>Insulation voltage</b>	kV power frequency 50 Hz - 1 min	20	28	20	28	38		50
	kV lightning impulse 1.2/50 µs	60	75	60	75	95		125
<b>Rated current</b> (busbar intensity)	A	630	■	■	■	■	■	■
	1250	■	■	■	■	■	■	■
	2500	■	■	■	■	■	■	■
	3150	■	■	■	■	■	■	■
	4000	■	■	■	■	■	■	■
<b>Short time withstand current</b>	kA rms 3 s	31.5	31.5	50	40	31.5	40	16, 25, 31.5
<b>Dimensions</b>	mm	H		2300				2325
	W	570		700				900
	D (1)	1550		1550				1750
<b>Approximate mass</b>	kg	500		550				560

(1) Overall + 175 mm for 4-sided internal arcing protected switchboards.



#### MV devices

- 1 Busbars to connect the DI functional unit with other switchboard cubicles
- 2 Switch - earthing switch
- 3 MV fuses

#### LV control cabinet

- 4 Low voltage auxiliaries and protection, monitoring and control unit are in one control cabinet, separated from the medium voltage part

#### DI2

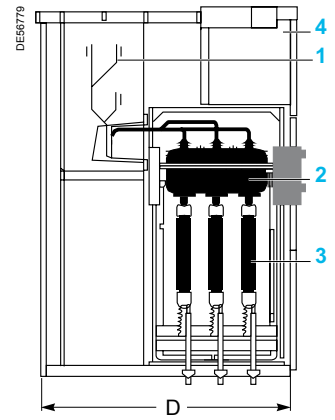
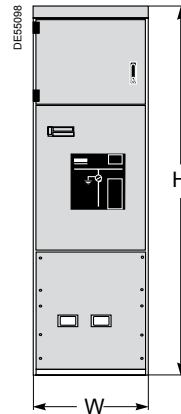
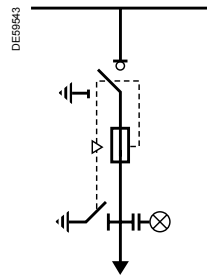

#### DI4

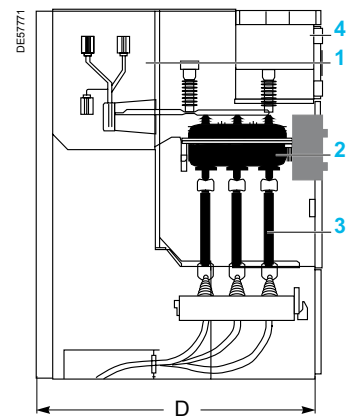
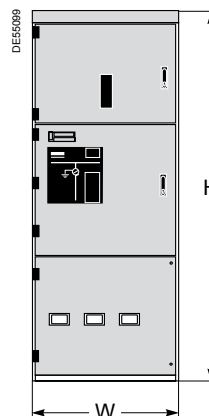
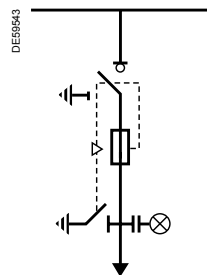

### Characteristics

				DI2		DI4		
<b>Rated voltage</b>			kV	7.2	12	17.5	24	
<b>Insulation level</b>	Insulation	Ud	50/60 Hz - 1 min	kV rms	20	28	38	50
			50/60 Hz - 1 min	kV rms	23	32	45	60
	Insulation	Up	1.2/50 μs	kV peak	60	75	95	125
			1.2/50 μs	kV peak	70	85	110	145
<b>Rated current</b>		200	A	■	■	■	■	
Short time withstand current			kA rms 1 s (2)	25	25	25	25	
<b>Dimensions</b>		mm	H	2300		2325		
			W	700		900		
			D (1)	1550		1750		
Approximate mass		kg		750	640			

(1) Overall + 175 mm for switchboard internal arcing 4 sides.

(2) Limited by fuses.

DI cubicles including a switch-fuse are used to supply power and protect low power transformers.

E.g.: auxiliary service transformers in primary substations.

#### All functional interlocks meet recommendations in IEC 62271-200:

- The switch is only possible to close if the earthing switch is open and the connection access panel is in place
- Closing of the earthing switch is only possible if the switch is open
- Opening of the access panel to medium voltage connections and fuses is only possible when the earthing switches upstream and downstream of the fuses are closed
- The switch is locked in the open position when the access panel is taken off

The voltage presence indicator is situated on the front face of the functional unit, integrated in the switch's control panel.

# Functions and characteristics

## Motorpact

## Motorpact protection and control

### Motorpact, an innovative range of motor starters with vacuum technology contactor

Motorpact is a motor monitoring and control switchboard that can be combined with an MCset switchboard by means of a transition panel.

PEES141



### Main characteristics:

- b Rated voltage 7.2 kV
- b Maximum busbar rating: 3150 A
- b Busbar rated short time withstand current: 50 kA 3 s
- b Internal arc withstand: 25 kA 1 s  
40 kA 0.5 s  
50 kA 0.25 s
- b Rated operational current: 400 A
- b Maximum fuse rating: 2 x 315 A

**Note:** for details, see *Motorpact catalogue no. AMTED302059*.

Motorpact motor starters provide a wide range of applications including reduced voltage starting:

- FVNR: direct on line motor starter
- RVAT: reduced voltage autotransformer motor starter
- RVSS: reduced voltage SoftStart motor starter
- S3: Sequential Smart Starter

They are suitable for all MV motor applications in markets such as: oil & gas, mining, water, pulp and paper, for starting:

- Pumps
- Fans
- Compressors
- Crushers
- Conveyors, etc.

### Compactness

- Compact dimensions thanks to a 375 mm width for direct on line motor starter
- Sofstarter and autotransformer are built into the switchboard

### Safety

- Full cubicle protection for internal arc withstand (AFLR 4 sides)
- Electrical and mechanical interlocking, closed door operation
- Visible disconnection and earthing by means of portholes

### Reliability

- Fewer components and fasteners.

### Less maintenance

- Corrosive atmosphere withstand
- Maintenance free disconnecter (capacity: 5000 operations)
- Front access to compartments

### Characteristics

Installation	Indoor type
Maximum rated voltage	7.2 kV
Insulation voltage	
Power frequency withstand (1 min)	20 kV 32 kV optional
Impulse withstand voltage (1.2/50 µs, peak value)	60 kV
Maximum rated short time withstand current (busbars)	50 kA 3 s
Rated frequency	50/60 Hz
Busbar rated current	2500 A 3150 A
Degree of protection	
Enclosure	IP3X, IP4X, IPX1, IPX2
Between compartments	IP2XC

## The Motorpact range includes 3 types of motor starters

### FVNR - Full voltage non-reversing asynchronous motor starter

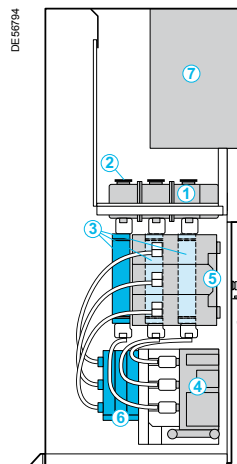
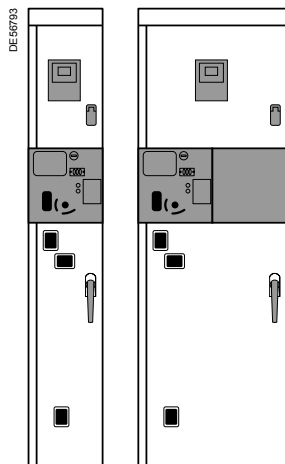
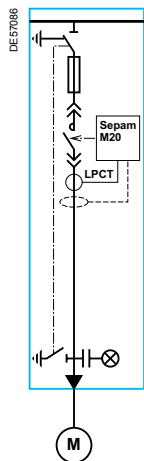

#### MV devices

- 1 Line disconnector
- 2 Busbars
- 3 Fuses
- 4 Contactor
- 5 Earthing switch
- 6 LPCT current sensors, Current Transformer and earth fault sensor

#### LV control cabinet

- 7 LV protection, measurement and control devices

### RVAT - Auto-transformer asynchronous motor starter

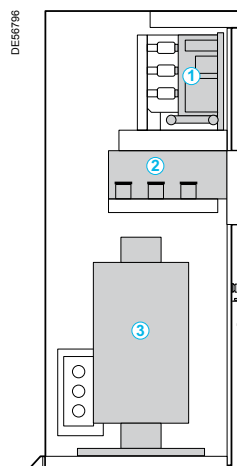
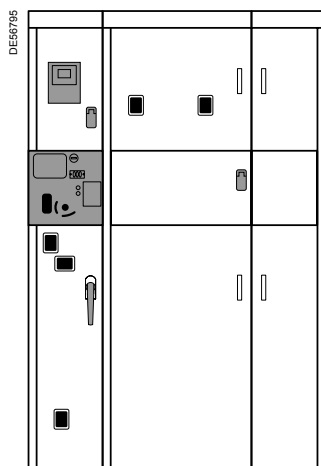
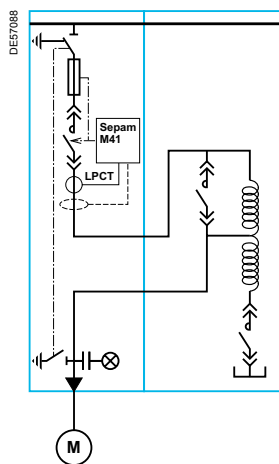

- 1 Run and start vacuum contactor
- 2 Busbars
- 3 Auto-transformer

### RVSS - Softstart asynchronous motor starter

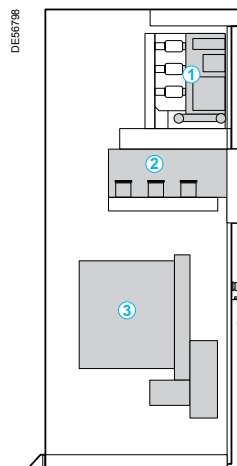
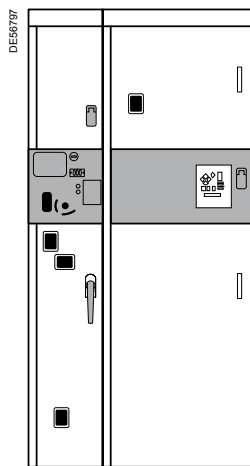
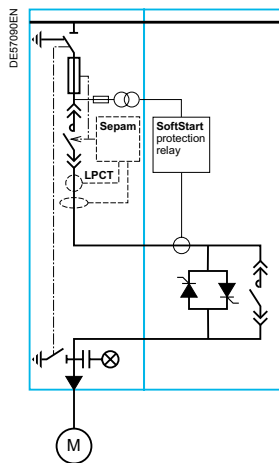

- 1 Bypass vacuum contactor
- 2 Busbars
- 3 SoftStart power stack

# Functions and characteristics

## Motorpact

### Motorpact transition panel (MTP)

By using a transition panel, it's easy to connect a MCset 17.5 kV switchboard with a Motorpact switchboard (left or right).

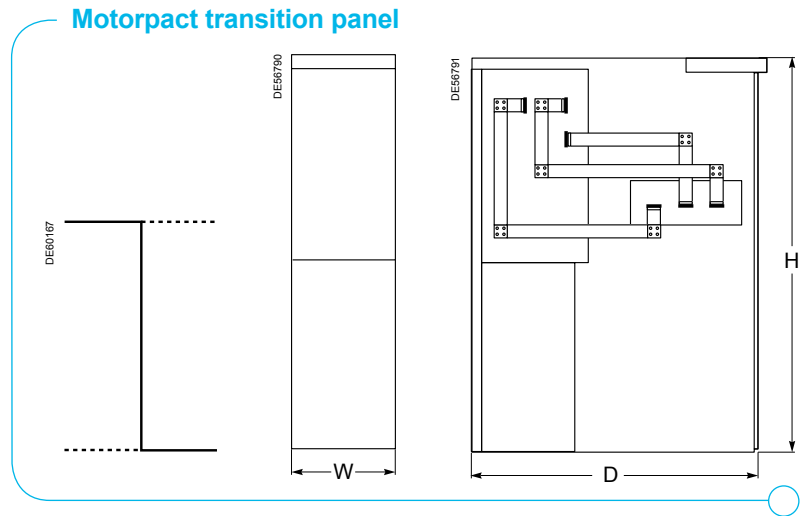

### Composition

#### Basic equipment

- 1 enclosure (standard IP3X)
- 1 set of busbars in separate compartment
- 1 removable front panel

#### Options

- Internal arc withstand (limited at 31.5 kA 1s)
- IP4X or IPX1 enclosure
- Encapsulated busbars

### Characteristics

Maximum rated voltage		7.2 kV
Insulation voltage	Power frequency withstand (1 min)	20 kV
	Lightning impulse withstand (1.2/50 $\mu$ s, peak value)	60 kV
	Busbar ratings	630 A
		1250 A
		2500 A
		3150 A
Dimensions	H	2300 mm
	W	375 mm
	D	1550 mm
Approximate mass	1250 A	240 kg
	2500 A	275 kg
	3150 A	310 kg





PE89234

*MCset lined up with Motorpact*



# Switchgear / Apparatus MCset design

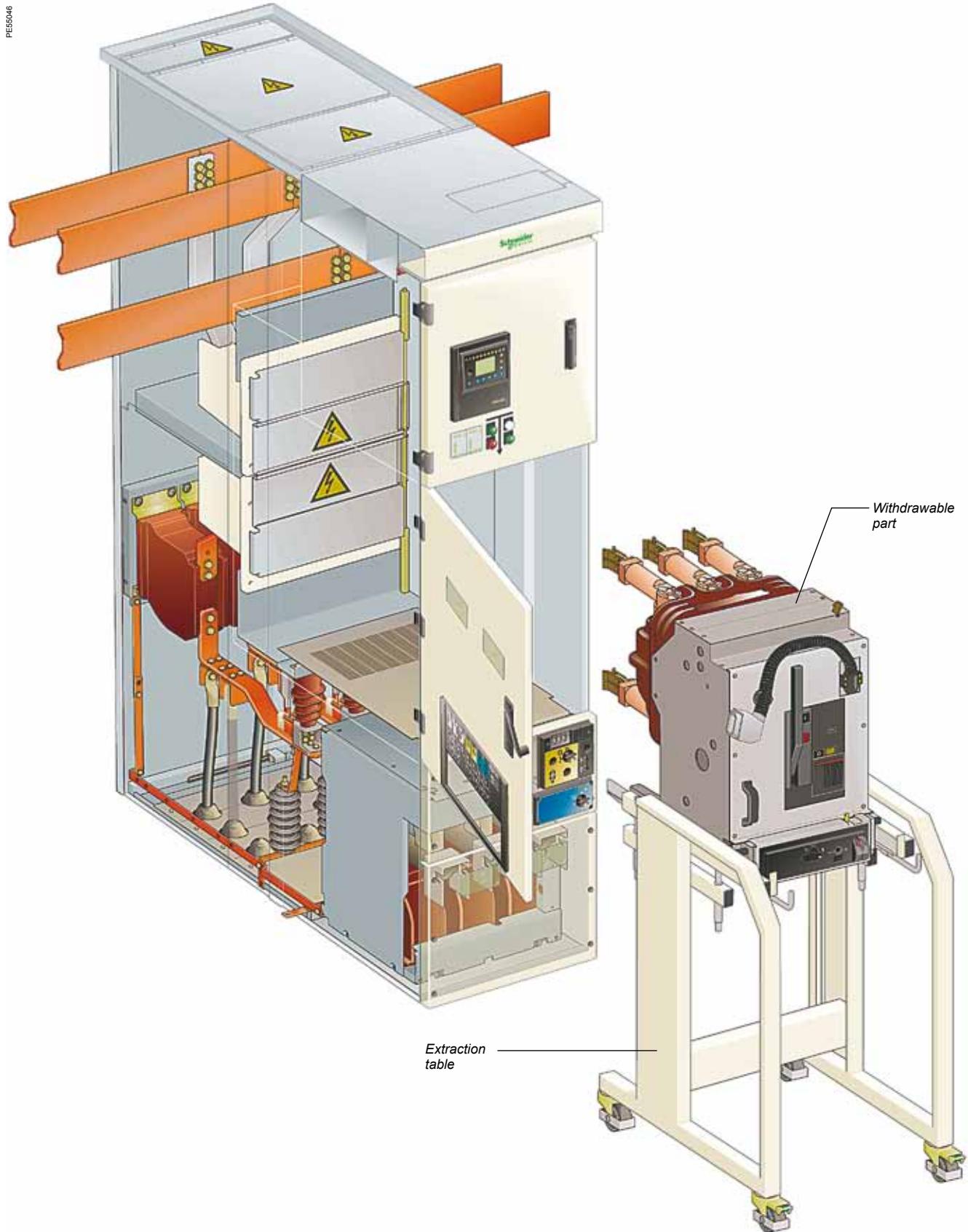

**The devices used to equip the MCset range of functional units have outstanding features:**

- b Long service life
- b Maintenance-free live parts
- b High electrical endurance
- b Operating safety
- b Insensitivity to the environment

**The withdrawable parts:**

- b The circuit breaker or contactor, the disconnecter truck or the earthing truck
- b The lever-type propulsion mechanism for racking in-out
- b Interlocks to fix the withdrawable parts onto the fixed part.

The live parts are housed in an insulating enclosure in the sealed pressure system in compliance with IEC 62271-100.

**Circuit breaker**

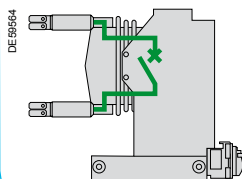

A circuit breaker is a safety device enabling switching and protection of electrical distribution networks. Installed in the MCset cubicle, it protects all of the components situated downstream during a short-circuit.

- Breaking in SF6
- LF
- SF

**Contactor**

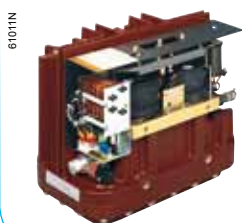

The contactor is a motor control and protection device.

- Breaking in SF6
  - Rollarc
- All accidental overpressure would be limited by the safety disk opening.

**Earthing truck**

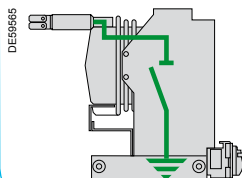

The earthing truck is a safety feature which allows the cubicle busbar to be earthed. It is installed instead of the circuit breaker and has the same interlock possibilities.

**Disconnecter truck**

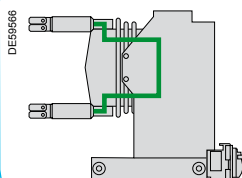

The disconnecter truck enables the upper and lower part of the cubicle to be short-circuited. It is installed instead of the circuit breaker and has the same interlock possibilities.

# Switchgear / Apparatus

## LF circuit breaker

### Presentation

PE5629



#### Description of the device

##### The LF circuit breaker consists of:

- The circuit breaker unit with its operating mechanism:
  - 3 poles integrated in a “sealed pressure system” type insulating enclosure  
The sealed assembly is filled with SF6 gas at low relative pressure (0.15 Mpa/1.5 bars) and equipped with a pressure switch.
  - An RI stored energy electrical operating mechanism  
This gives the device an opening and closing speed that is independent of the operator, for both electrical and manual orders. It enables reclosing cycles to be carried out.
  - A front panel housing the manual operating mechanism and status indicators
- The components enabling it to be withdrawable:
  - The circuit breaker is equipped with racking arms and contact fingers and mounted on a racking in/out drive device with a threaded shaft activated by a handle, including all of the safety interlock systems
  - A Harting type male LV connector allows connection of the external auxiliary circuits

##### Each device can optionally be fitted with:

- Locking of the circuit breaker in the following positions:
  - Open, by a key lock installed on the control panel
  - Racked out, by a key lock installed on the drive device.

#### Specific applications

##### Protection of generators and power station auxiliaries

All circuit breakers in the LF range break short circuit currents with an asymmetry of at least 30%.

In cases where the network constant X/R is greater than 45 ms, the asymmetry to be broken is higher; this is often the case of circuit breakers protecting nuclear or thermal power station auxiliaries or circuit breakers that are close to generator sets or large transformers.

Specific tests have been carried out:

Circuit breakers	kV	kA	Asymmetry
LF2	7.2	43.5	50%
LF3	7.2	43.5	50%
	12	40	50%
	17.5	25	100%

##### Switching and protection of capacitor banks

LF range circuit breakers are particularly well suited to switching and protection of capacitor banks; they are classed C2 according to standard IEC 62271-100. Tests are carried out according to the standard for breaking at 400 A with making and breaking cycles in the case of a capacitor bank with a making current of 20 kA. Additional tests have been carried out: please consult us.



**Characteristics of LF circuit breakers in MCset cubicles**  
The electrical characteristics are given on the circuit breaker designation (rating plate).

Electrical characteristics according to IEC 62271-100				LF1/MCset				LF2/MCset				
Rated voltage	<b>Ur</b>	kV 50/60 Hz	7.2	12			7.2	12		17.5		
Insulation voltage												
- power frequency withstand	<b>Ud</b>	kV 50 Hz 1min (1)	20	28			20	28		38		
- lightning impulse withstand	<b>Up</b>	kV peak	60	75			60	75		95		
Rated current	<b>Ir</b>	A	630	■	■	■	■	■	■	■	■	
		1250	■	■	■	■	■	■	■	■	■	
Short circuit current	<b>Isc</b>	kA	25	31.5	25	31.5	40	50	40	25	31.5	
Short time withstand current	<b>Ik/tk</b>	kA/3 s	25	31.5	25	31.5	40	50 (2)	40	25	31.5	
Short-circuit making current	<b>Ip</b>	kA peak	50 Hz	63	79	63	79	100	125	100	63	79
		60 Hz	65	82	65	82	104	130	104	65	82	
Rated switching sequence		O-3 min-CO-3 min-CO	■	■	■	■	■	■	■	■	■	
		O-0.3 s-CO-3 min-CO	■	■	■	■	■	■	■	■	■	
		O-0.3 s-CO-15 s-CO	■	■	■	■	■	■	■	■	■	

				LF3/MCset									
Rated voltage	<b>Ur</b>	kV 50/60 Hz	7.2	12					17.5				
Insulation voltage													
- power frequency withstand	<b>Ud</b>	kV 50 Hz 1min (1)	20	28					38				
- lightning impulse withstand	<b>Up</b>	kV peak	60	75					95				
Rated current	<b>Ir</b>	A	1250	-	-	-	-	-	-	■	-	-	■
		2500	■	■	■	■	■	■	■	■	■	■	■
		3150	-	-	-	-	-	-	-	■	-	-	■
		4000 (4)	-	-	-	■	-	-	-	■	-	-	■
Short circuit current	<b>Isc</b>	kA peak	25	31.5	40	50	25	31.5	40	50	25	31.5	40
Short time withstand current	<b>Ik/tk</b>	kA/3 s	25	31.5	40	50	25	31.5	40	50 (2)	25	31.5	40
Short-circuit making current	<b>Ip</b>	kA	50 Hz	63	79	100	125	63	79	100	125	63	79
		60 Hz	65	82	104	130	65	82	104	130	65	82	104
Rated switching sequence		O-3 min-CO-3 min-CO	■	■	■	■	■	■	■	■	■	■	■
		O-0.3 s-CO-3 min-CO	■	■	■	■	■	■	■	■	■	■	-
		O-0.3 s-CO-15 s-CO	■	■	■	■	■	■	■	■	■	■	-

(1) Ud 42 kV 50 Hz, 1 min possible.

(2) When  $I_n \leq 1250$  A, the rated short-circuit breaking duration (tk): 1 s.

(3) For other values, please consult us.

(4) With fan:

■ Available.

- Not available.

#### Specific applications according to IEC 62271-100

Operating times	Opening ms	48 ms	
	Breaking ms	70 ms	
	Closing ms	65 ms	
Service temperature	<b>T</b>	°C	-25 to +40
Mechanical endurance	Class	M2	
	Number of switching operations	10 000	
Electrical endurance	Class	E2	
Capacitive current breaking capacity	Class	C2	

# Switchgear / Apparatus

## LF circuit breaker

### RI stored energy operating mechanism

#### Presentation



#### Operation of the RI stored energy operating mechanism

This gives the device an opening and closing speed that is independent of the operator whether the order is electrical or manual.  
The electrical control mechanism performs the reclosing cycles and is automatically recharged by a geared motor each time after closing.

#### It consists of:

- A stored energy operating mechanism which stores the energy required to open and close the device in the springs
- A manual lever-operated spring arming device
- A geared electrical arming device which automatically re-arms the control mechanism as soon as the circuit breaker is closed (optional)
- Push button manual order devices on the front panel of the device
- An electrical remote closing device containing a release with an antipumping relay
- An electrical opening order device consisting of one or several release units which can be of the following type:
  - shunt opening
  - undervoltage
  - Mitop, a low consumption release, used only with the Sepam 100 LA protection relay.
- An operation counter
- An "open/closed" position indicator device with a mechanical indicator
- A device to indicate the "charged" operating mechanism status via mechanical indicator and electrical contact (optional)
- A module of 14 auxiliary contacts whose availability varies according to the diagram used
- A single contact pressure switch is activated when the gas pressure exceeds 0.1 MPa (relative pressure: 1 bar)

#### Wiring diagram (principle)

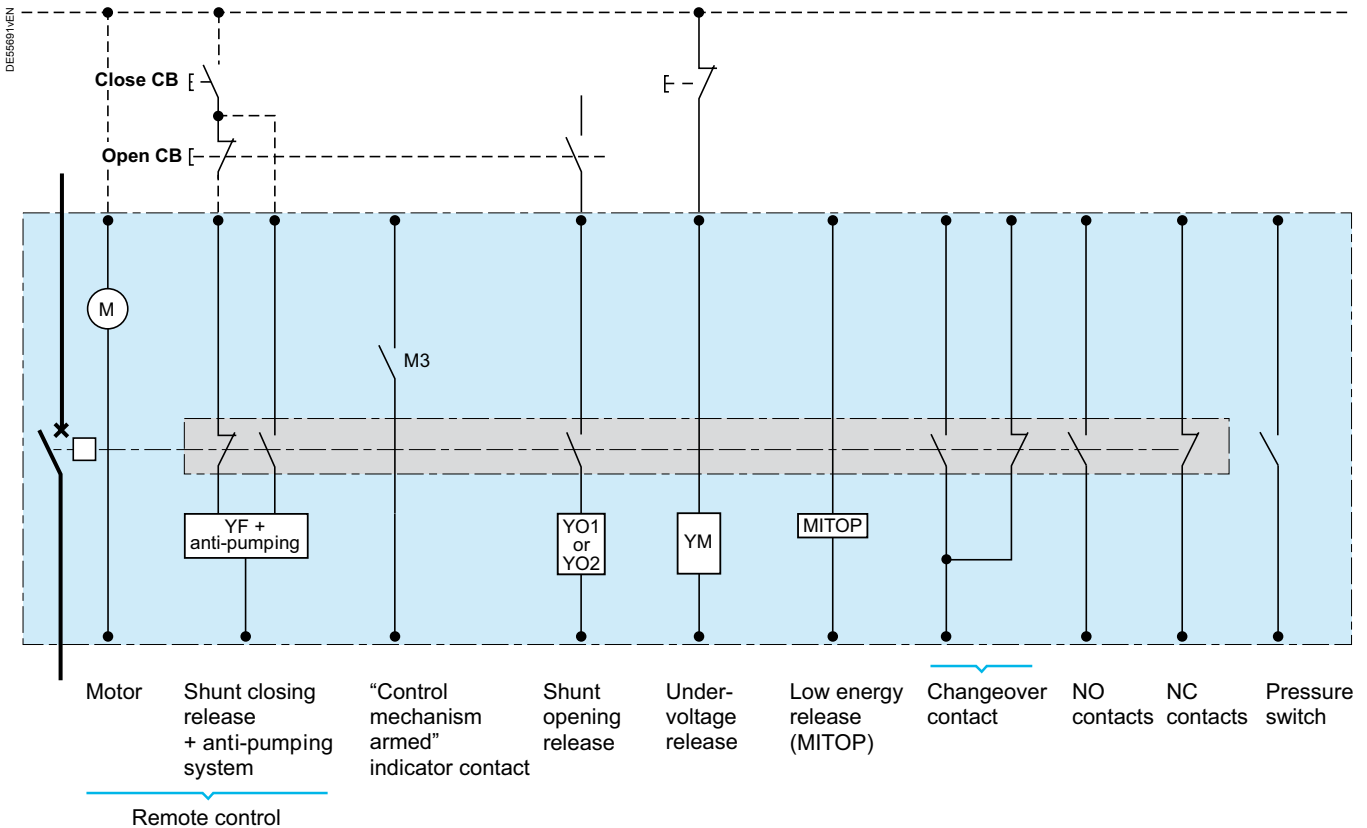

# Switchgear / Apparatus

## LF circuit breaker

### RI stored energy operating mechanism

### Opening circuit

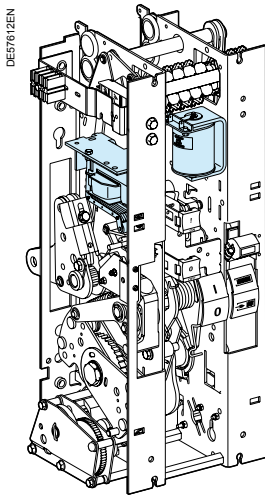

Operating mechanism



Shunt opening release (1)

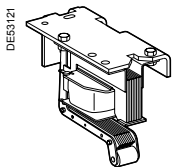

Undervoltage release (2)

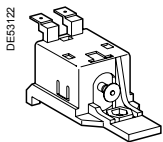

Low energy release (3)

#### Composition

The opening circuit can be produced using the following components:

- Shunt opening release (upon energising) (YO1)
- Second shunt opening release (upon energising) (YO2)
- Undervoltage release (YM)
- Low energy release (Mitop)

**Note:** see the table of the combinations of releases at page C-23.

#### Shunt opening release (YO1 and YO2)

Energising this release causes an instant opening of the circuit breaker.

##### Characteristics

Power supply	V AC (50 Hz)	48, 110, 220
	V AC (60 Hz)	120, 240
	V DC	24, 30, 48, 60, 110, 125, 220
Threshold	V AC	0.85 to 1.1 Ur
	V DC	0.7 to 1.1 Ur
Consumption	V AC	160 VA
	V DC	50 W

#### Undervoltage release (YM)

This release unit causes the systematic opening of the circuit breaker when its supply voltage drops below a value less than 35% of the rated voltage, even if this drop is slow and gradual. It can open the circuit breaker between 35% and 70% of its rated voltage. If the release unit is not supplied power, manual or electrical closing of the circuit breaker is impossible. Closing of the circuit breaker is possible when the supply voltage of the release unit reaches 85% of its rated voltage.

##### Characteristics

Power supply	V AC (50 Hz)	48, 110, 220	
	V AC (60 Hz)	120, 240	
	V DC	24, 30, 48, 60, 110, 125, 220	
Threshold	Opening	0.35 to 0.7 Ur	
	Closing	0.85 Ur	
Consumption	Triggering	V AC	400 VA
		V DC	100 W
	Latched	V AC	100 VA
		V DC	10 W

#### Low energy release (Mitop)

This specific release unit comprises a low consumption unit and is specifically used for Sepam 100LA self-powered relays.

##### Characteristics

Power supply	Direct current
Threshold	0.6 A < I < 3 A

Any tripping due to the Mitop release unit is momentarily indicated by an SDE type changeover contact (option).

# Switchgear / Apparatus

## LF circuit breaker

### RI stored energy operating mechanism

### Remote control

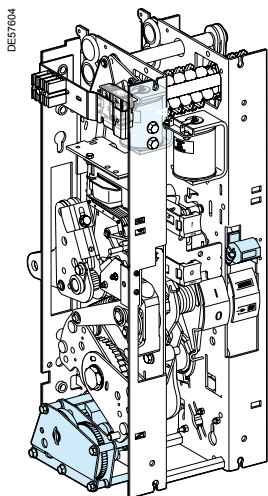

Operating mechanism

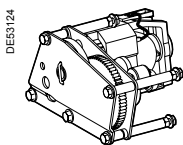

Electrical motor and gearing (4)



Shunt closing release (5)

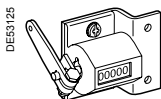

Operation counter (6)

#### Function

Remote control enables the remote opening and closing of the circuit breaker.

#### Composition

The remote control mechanism consists of:

- An electrical motor with gearing
- A shunt closing release (YF) combined with an anti-pumping device
- An operation counter

#### Electrical motor with gearing (M)

The electrical motor carries out the automatic rearming of the stored energy unit as soon as the circuit breaker is closed. This allows the instant reclosing of the device after opening. The arming lever is only used as a backup operating mechanism in the case of an absence of the auxiliary power supply.

The M3 contact indicates the end of arming operations.

#### Characteristics

Power supply	V AC	48...60, 110...127, 220...250
	V DC	24...32, 48...60, 110...127, 220...250
Threshold	V AC/V DC	0.85 to 1.1 Ur
Consumption	V AC	380 VA
	V DC	380 W

#### Shunt closing release (YF)

This release allows the remote closing of the circuit breaker when the operating mechanism is armed.

#### Characteristics

Power supply	V AC (50 Hz)	48, 110, 220
	V AC (60 Hz)	120, 240
	V DC	24, 30, 48, 60, 110, 125, 220
Threshold	V AC	0.85 to 1.1 Ur
	V DC	0.85 to 1.1 Ur
Consumption	V AC	160 VA
	V DC	50 W

The shunt closing release is combined with an anti-pumping relay that enables priority to be given to opening in the case of a permanent closing order. This thus avoids the device being caught in an uncontrolled opening-closing cycle.

#### Operation counter

The operation counter is visible on the front panel.

It displays the number of switching cycles (CO) that the device has carried out.

# Switchgear / Apparatus

## LF circuit breaker

### RI stored energy operating mechanism

### Indication and locking/interlocking

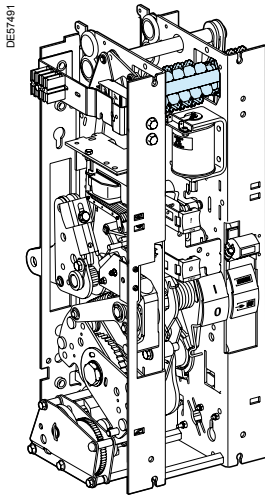

Operating mechanism

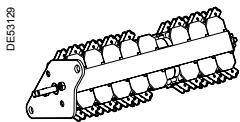

Auxiliary contacts (7)

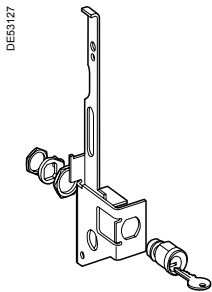

Keylocking kit (8)

#### “Open/closed” auxiliary contacts

The number of contacts available depends on the options chosen on the operating mechanism.

In the basic configuration, the circuit breaker's operating mechanism mechanism consists of a total of:

- 5 normally closed contacts (NC)
- 5 normally open contacts (NO)
- 1 changeover contact (CHG)

The usage procedure for auxiliary contacts is given in the following table:

Options	NC contact	NO contact
Shunt opening release (each one)	0	1
Undervoltage release	0	0
Low energy release (Mitop)	0	0

In order to know the final number of available contacts, you must deduct the total number of contacts included in the circuit breaker (5 NC + 5 NO + 1 CHG), the number of contacts used is given in the table above.

**E.g.:** a circuit breaker equipped with a remote control and a shunt trip unit has the following available contacts:

5 NC + 4 NO + 1 CHG.

With a undervoltage release instead of a shunt trip, this circuit breaker would have the following available contacts:

5 NC + 5 NO + 1 CHG.

Shunt opening release combinations			
1st release	Shunt opening release YO1	Undervoltage release YM	Mitop
<b>2nd release</b>			
<b>Without</b>	5NC + 4NO + 1CHG	5NC + 5NO + 1CHG	5NC + 5NO + 1CHG
<b>Shunt opening release YO2</b>	5NC + 3NO + 1CHG	5NC + 4NO + 1CHG	5NC + 4NO + 1CHG
<b>Undervoltage release YM</b>	5NC + 4NO + 1CHG		5NC + 5NO + 1CHG
<b>Mitop</b>	5NC + 4NO + 1CHG	5NC + 5NO + 1CHG	

#### Locking the circuit breaker in the “open” position

This key-operated device allows the circuit breaker to be locked in the “open” position. The circuit breaker is locked in the open position by blocking the opening push button in the “engaged” position.

Locking is achieved using a Profalux or Ronis captive key type keylock.



# Switchgear / Apparatus

## SF circuit breaker

### Presentation - Characteristics

PE66744

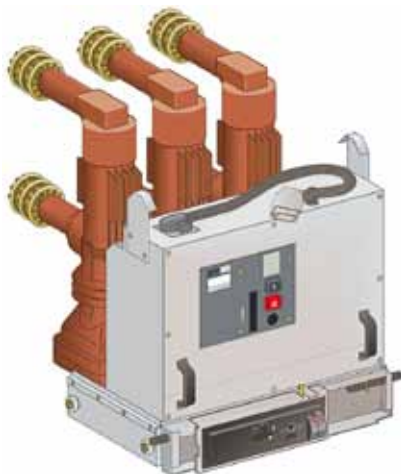

#### SF range circuit breakers equip cubicles AD4 and CL4 for rated voltage values of 24 kV.

They work on the basis of the “puffer” type principle in SF6, which is used as a breaking and insulating medium.

Each of the 3 poles has an independent insulating enclosure which forms a filled pressure system in compliance with IEC standard 62271-100.

Each pole forms a gas-tight unit filled with low pressure SF6 at a low relative pressure of 0.05 to 0.35 MPa (0.5 to 3.5 bars) according to the performance level required.

No filling is required during the life of the equipment.

According to the performance levels, it is possible as an option to equip SF6 circuit breakers with a pressure switch to act on an alarm in the case of a pressure drop.

SF6 range circuit breakers are actuated by a GMH type spring mechanism.

#### Principle of the puffer breaking technique

The main contacts and arcing contacts are initially closed (Fig. 1).

##### Pre-compression (Fig. 2)

When the contacts begin to open, the piston slightly compresses the SF6 gas in the pressure chamber.

##### Arcing period (Fig. 3)

The arc appears between the arcing contacts. The piston continues its downward movement. A small quantity of gas, directed by the insulating nozzle, is injected across the arc. For the breaking of low currents, the arc is cooled by forced convection. However, for high currents, thermal expansion causes the hot gases to move towards the cooler parts of the pole unit.

The distance between the two arcing contacts becomes sufficient for the current to be broken when it reaches the zero point due to the dielectric properties of the SF6.

##### Sweeping overstroke (Fig. 4)

The moving parts finish their movement and the injection of cold gas continues until the contacts are completely open.

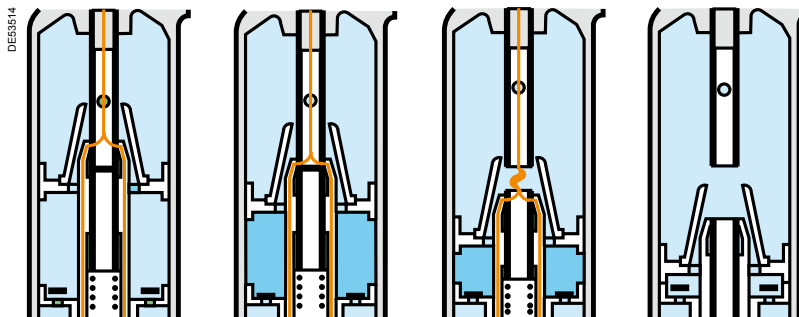

Fig.1

Fig.2

Fig.3

Fig.4

#### Characteristics of SF circuit breakers in MCset cubicles

Electrical characteristics			SF1/MCset		SF2/MCset	
Rated voltage	kV, 50/60 Hz		24	24	24	24
Insulation level	kV, rms 50 Hz - 1 min		50	50	50	50
	kV, impulse 1.2/50 $\mu$ s		125	125	125	125
Rated nominal current (Ia)	A	630	■	■		■
		1250		■		■
		2500			■	■
Breaking capacity Isc	kA, rms		16	25	25	31.5
Making capacity	kA, peak		40	63	63	80
Short time withstand current	kA, rms 3 s		16	25	25	31.5
Capacitor breaking capacity	A	630	440	440		440
		1250		875		875
		2500			1750	1750
Rated operating sequence	O-3 min-CO-3 min-CO		■	■	■	■
	O-0.3 s-CO-3 min-CO		■	■	■	■
	O-0.3 s-CO-15 s-CO		■	■	■	■
Approximate operating time for supply of releases at Un	ms	Opening	50		50	
		Breaking	65		65	
		Closing	70		70	
Mechanical endurance	Number of switching operations		10 000		10 000	

# Switchgear / Apparatus

## SF circuit breaker

### GMH operating mechanism

026366



SF range circuit breakers are actuated by a GMH operating mechanism that ensures switching device closing and an opening rate that is independent of the operator. This operating mechanism, always motorised, enables remote operation and fast reclosing cycles.

**The GMH operating mechanism includes:**

- A spring system that stores the energy needed to close and open the breaker
- A manual spring charging system
- An electrical motor spring charging device that automatically recharges the mechanism as soon as the contacts close (recharging time < 15 s)
- Two mechanical push buttons for opening and closing, accessible with the cubicle door open (circuit breaker in test position)
- An electrical closing system containing a closing release for remote control and an anti-pumping relay
- An electrical opening system containing one or more opening releases of the following type:
  - shunt
  - undervoltage.
- An operation counter
- An optional "operating mechanism charged" indication contact
- An end-of-charging contact
- A black-white mechanical "open-closed" position indicator
- A multi-pin connector to isolate auxiliary circuits in the "racked out" position

The GMH operating mechanism is equipped with a block of 14 auxiliary contacts including:

- 1 changeover contact for the electrical operating mechanism
- 1 changeover contact for indication
- 1 contact for the shunt release

**Contact characteristics**

<b>Rated current</b>		10 A
<b>Breaking capacity</b>	AC 220 V (cos φ ≥ 0.3)	10 A
	DC 110 or 220 V (L/R ≤ 0.01 s)	1.5 A

**GMH operating mechanism characteristics**

Type of auxiliaries		Spring charging motor (M)	Closing release (YF)	Opening release		Undervoltage (YM)	Available contact		
				Shunt (YO1-YO2) Single	Double		NC	NO	Ch
<b>Supply voltage</b>	AC (V)	50 Hz	50 - 100 - 140 - 200 - 250 - 380						
		60 Hz	60 - 110 - 127 - 220 - 250						
<b>Consumption</b>	DC (V)		24 - 33 - 48 - 60 - 110 - 136 - 220 - 260						
		AC (VA)	700	120	120	240	400/100 (1)		
	DC (W)	570	70	70	140	100/10 (1)			
<b>Possible combinations of auxiliaries and quantities</b>		■	■	■		■	5	4	1
	or	■	■	■			5	4	1
	or	■	■		■		5	3	1
	or	■	■		■	■	5	3	1
	or	■	■			■	5	3	1
	or	■	■	■			■	5	5

(1) Pick-up/latched consumption.

**Wiring diagram (principle)**

- J** Circuit breaker
- M** Spring charging motor
- YF** Closing release
- M1-M2** End-of-charging contact
- QF** Auxiliary circuit breaker contacts
- KN** Anti-pumping relay
- SE** Latched release contact
- Y01-Y02** Shunt opening releases
- YM** Undervoltage opening release
- M3** Operating mechanism charged contact
- SP** Pressure switch contact
- SQ** Device ready-to-operate contact
- Sm1** Closing push button (external)
- Sm2** Opening push button for shunt releases (external)
- Sm3** Opening push button for undervoltage releases (external)
- Sn** Closing disabling contact (external)

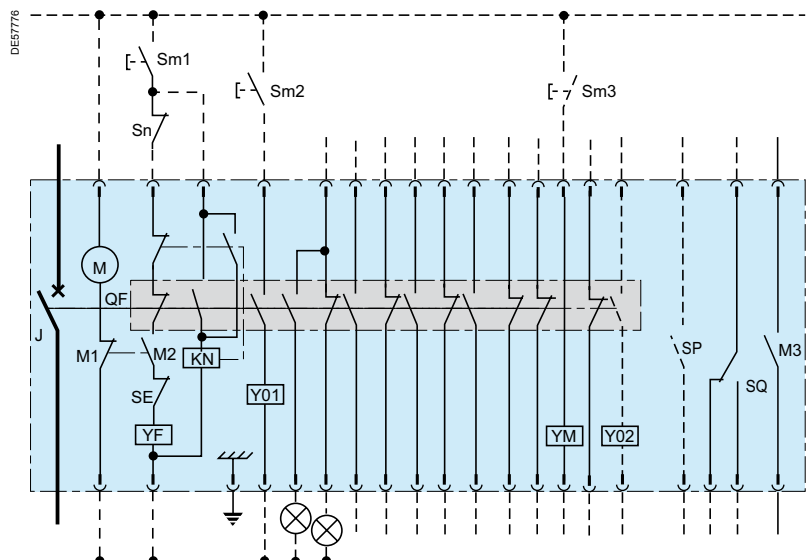

# Switchgear / Apparatus

## Rollarc contactor

### Presentation

PE56240



#### Description

- Three main poles are located in the pressurised enclosure
- Electromagnetic operating mechanism with:
  - magnetic latching for Rollarc 400
  - mechanical latching for Rollarc 400D
- Upstream and downstream terminals for power circuit connections
- Pressure switch equipped with a NO contact for continuous monitoring of SF6
- Mechanical interlocking of the contactor in the open position to prevent racking in or out with the contacts closed
- 3 HPC fuses with striker pin and auxiliary contact to trip the contactor

#### Auxiliaries diagram (principle)

##### Operating mechanism for Rollarc 400 contactors

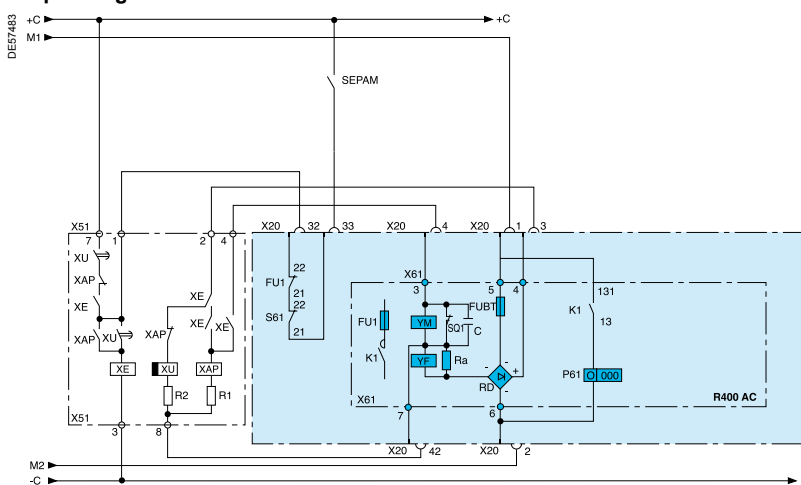

##### Operating mechanism for Rollarc 400D contactors

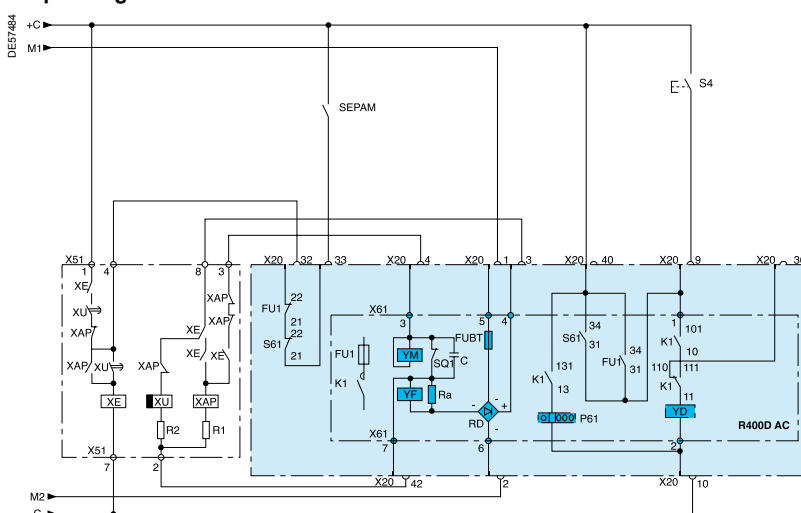

- FU1** MV fuses
- FUBT** LV fuse
- K1** R400 AC MV contactor
- P61** Operation counter
- S61** Locking contact activated by the pre-trip push button and during racking in/out operations
- SQ1** Contactor limit switch
- X20** LV connector, 42 pins + earth
- X51** Control plate
- X61** Contactor terminal block
- XAP** Instantaneous auxiliary relay
- XE** Instantaneous auxiliary control relay
- XU** 0.6 s time delay auxiliary relay
- YD** Shunt trip coil
- YF** Closing coils
- YM** Latching coil
- S4** Trip button

#### Electrical characteristics of the Rollarc R400/R400D (1) in MCset cubicles

Rated voltage (kV)	Dielectric strength		Max. operating current (A)	Rated contactor current (A)	Fuse breaking capacity (2) (kA rms)	Short time withstand current (3)	
	50 Hz 1 min (4) (kV rms)	Impulse 1.2/50 $\mu$ s (kV peak)				(kA rms)	(kA peak)
7.2	20	60	250	400	50	50	125
12	28	60	200	400	50	50	125

(1) Rollarc 400: without mechanical latching. Rollarc 400D: with mechanical latching.

(2) For operating voltages of 3 to 12 kV.

(3) Limited by fuses.

(4) 32 kV 1 min possible upon specific request (consult us).

#### Maximum switchable power

##### Calculation assumptions (motor)

- Ratio between starting current  $I_d$  and maximum current  $I_n$ :  $I_d/I_n = 5 \pm 20\%$
- Power factor x efficiency  
 $0.88 \times 0.9 = 0.792$  for  $300 \leq P < 600$  kW  
 $0.9 \times 0.92 = 0.828$  for  $600 \leq P < 1100$  kW  
 $0.92 \times 0.94 = 0.865$  for  $1100 \leq P < 5000$  kW
- Starting time  $< 10$  s
- Starts per hour  $\leq 3$  according to IEC 60644

Operating voltage (kV)	Direct starting motor with 315 A fuses (kW)	Transformer with 315 A fuses (kVA)	Capacitor with 315 A fuses (kvar)
3.3	1170	1430	1000
4.16	1480	1800	1260
5	1780	2160	1520
5.5	1960	2380	1670
6	2130	2600	1820
6.6	2350	2800	2000
10 (fus. 200 A)	2000	2250	2000

#### Operating schemes

##### Temporary service or periodic service

The two curve systems (Fig. 1 and 2) can be used to determine the maximum current surges accepted by the Rollarc 400 contactor, in temporary or periodic service.

- Temporary service: knowing the steady state current  $I_p$ , we can determine the maximum duration  $T_s$  of a current surge  $I_s$  from **graph 1** (Fig. 2).
- Periodic service: knowing 3 of the following 4 parameters:
  - overcurrent  $I_s$
  - overcurrent time  $T_s$
  - cooling current  $I_r$
  - cooling time  $T_r$ .

We can determine the 4<sup>th</sup> parameter using **graph 2** (Fig. 1 and 2).

##### Operating time

- Opening time 20 to 35 ms.
- Arcing time:  $< 20$  ms.
- Closing time: 80 to 120 ms.

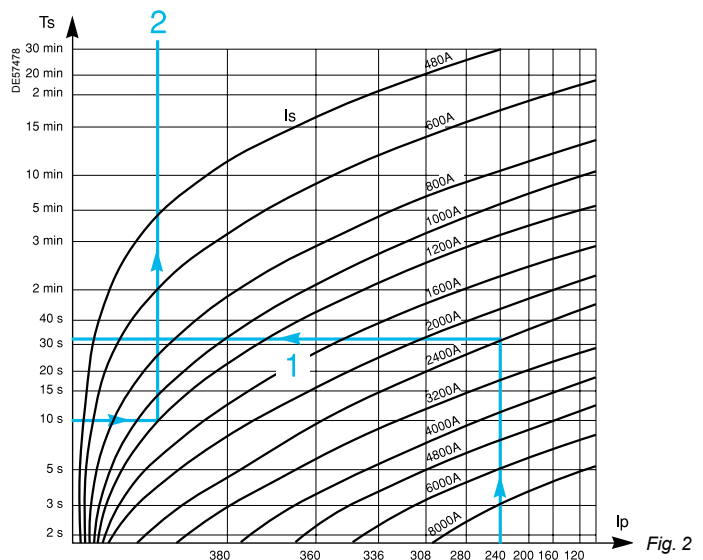
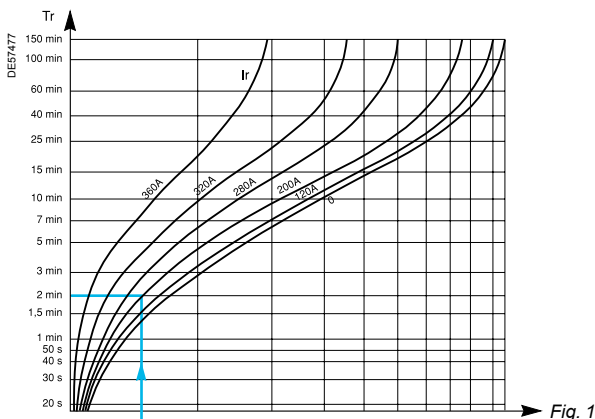

# Switchgear / Apparatus

## Rollarc contactor

### Characteristics

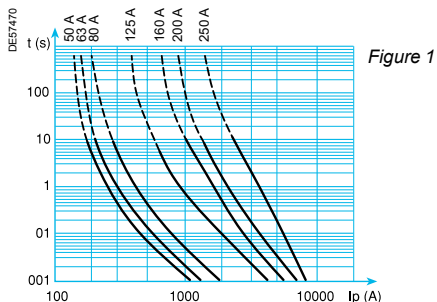

Figure 1

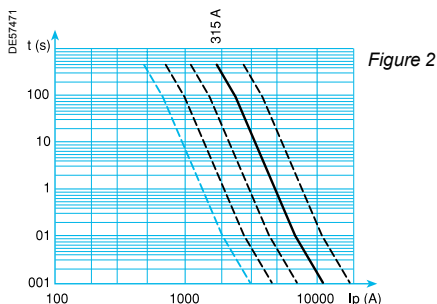

Figure 2

#### Trip curves

The trip curves for Fusarc CF (figure 1) and Ferraz (figure 2) fuses are shown above. These are the average curves with an rms current value tolerance  $I \pm 10\%$ .

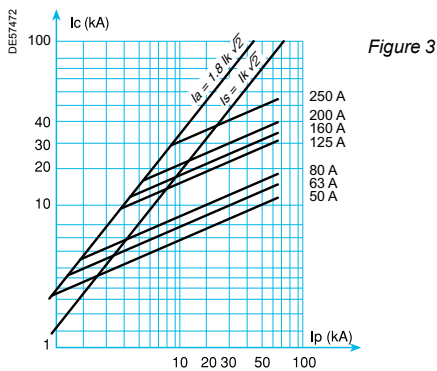

Figure 3

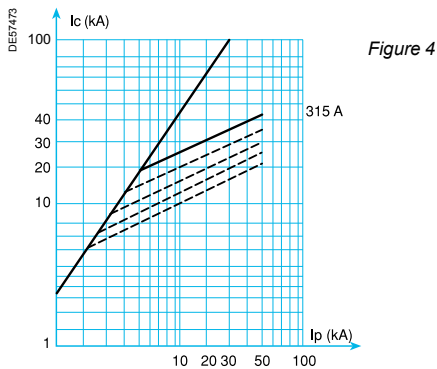

Figure 4

#### Limitation curves

Fusarc CF (figure 3) and Ferraz (figure 4) fuses have current limiting capacity. These curves give the maximum value of the limited breaking current  $I_c$  (in kA peak), as a function of the value  $I_p$  (in kA rms) of the presumed current that would be created if there were no protection. For further details, you can request the fuse catalogues.

#### Fuses

The fuses used are the **FUSARC CF** or **FERRAZ** type (Standard IEC 60282.1 and DIN 43625) with high breaking capacity. Substantial fault current limitation reduces the electrodynamic stresses on the load-side components (contactor, cables, CT, etc). A "blown fuse" device is used to open the three poles of the contactor.

Rated voltage (kV)	7.2	12
Max. fuse rating (A)	315*	250*
Breaking capacity (kA)	50	50

(\*) please consult us

#### Trip curves

The trip curves for FUSARC CF (Fig. 1) and FERRAZ (Fig. 2) fuses are shown opposite. These are the average curves with an rms current value tolerance  $\pm 10\%$ .

#### Limitation curves

FUSARC CF (Fig. 3) and FERRAZ (Fig. 4) fuses have current limiting capacity. These curves give the maximum value of the limited breaking current  $I_c$  (in kA peak), as a function of the value  $I_p$  (in kA rms) of the presumed current that would be created if there were no protection. For further details, you can request the fuse catalogues.

#### Operating mechanism

##### Supply voltage (1)

DC: 48, 110, 127 and 220 V

AC: 50, 100, 110, 127 and 220 V

Acceptable variations: +10% -15%

##### Rollarc 400 contactor

The contactor is closed by the pick-up coils. The latching coils are inserted in the circuit at the end of the stroke of the contactor.

Consumption	Pick-up	Latched
DC	1050 W	30 W
AC	900 VA	30 VA

##### Rollarc 400D contactor

The contacts are mechanically latched in the closed position. They are opened by a shunt trip release which releases the latching.

Consumption	Pick-up coil (2)	Shunt trip
DC	1050 W	80 W
AC	900 VA	100 VA

(1) Optional supply possible by auxiliary transformer (see page E-16).

(2) Supply time < 0.12 s.

#### Auxiliary contacts

Auxiliary contacts are of the common point changeover type. The following are available:

- 9 contacts for the Rollarc 400
- 8 contacts for the Rollarc 400D

#### Contact characteristics:

Rated current: 10 A	
Breaking capacity:	DC (L/R $\leq$ 0.01 s): 2 A at 110 V
	CA (cos $\varphi \geq$ 0.3): 10 A at 220 V



# Switchgear / Apparatus

## DI switch cubicle

### Presentation

EF7422



#### Loadbreak switch

The three rotating contacts are placed in an enclosure filled with gas at a relative pressure of 0.04 MPa (0.4 bars).

The system offers maximum operating reliability.

#### Gas tightness

The SF6 filled enclosure is a "sealed pressure system" type. Sealing tightness is always checked at the factory.

#### Safety

- The switch may be in one of three positions: "closed", "open" or "earthed", creating a natural interlocking system that prevents operator error
- Moving contact rotation is driven by a fast-acting mechanism that is independent of the operator
- The device combines the breaking and disconnecting functions
- The SF6-enclosed earthing switch has a short-circuit making capacity in compliance with the relevant standards

#### Insensitivity to the environment

- Parts are designed in order to obtain optimum electrical field distribution
- The metallic structure of cubicles is designed to withstand an aggressive environment and make it impossible to access any energised part during operation

#### Breaking principle

The outstanding qualities of SF6 gas are used to extinguish the electrical arc. To increase the cooling of the arc, a relative movement is created between the arc and the gas. The arc strikes when the fixed and moving contacts separate. The combination of the current and magnetic field created by a permanent magnet causes the arc to rotate around the fixed contact, extending and cooling it until it is extinguished at current zero point. The distance between the fixed and moving contacts is then sufficient to withstand the recovery voltage. This system is both simple and dependable, and provides improved electrical endurance due to the very low wear of contacts.

DE57488v

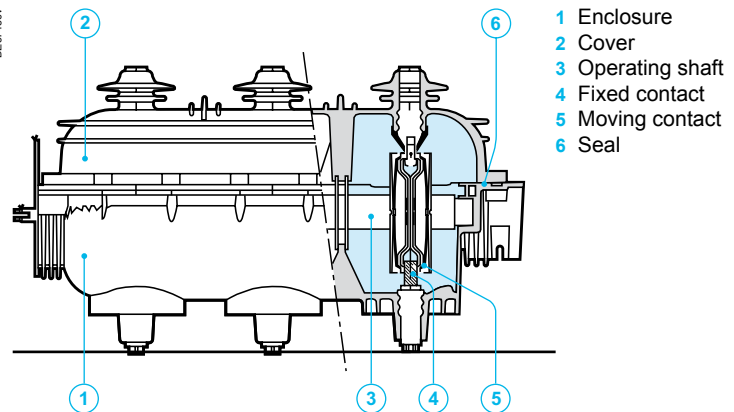

MT20184

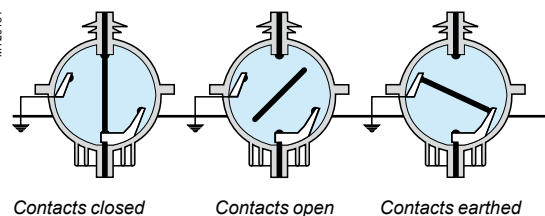

# Switchgear / Apparatus

## DI switch cubicle

### Characteristics

041497R



#### Operating mechanism and auxiliaries

##### CI2 double function operating mechanism

###### ■ Switch function:

- independent closing in two steps:
  - operating mechanism recharged by a hand lever or motor
  - stored energy released by a push button (I) or trip unit
- independent opening by push button (O) or trip unit

###### ■ Earthing switch function:

- independent closing by a hand lever

Operating energy is provided by the compression of a spring which causes the contacts to close or open after the neutral point is passed.

###### ■ Auxiliary contacts:

- switch (2 O + 2 C)
- switch (2 O + 3 C) and earthing switch (1 O + 1 C)
- switch (1 C) and earthing switch (1 O + 1 C) in the motor option

###### ■ Motor option

###### ■ Opening release:

- shunt
- undervoltage (optional)

###### ■ Closing release: shunt trip

- **Fuse blown release:** any fuse blown trips the opening of the switch

#### Motor option and releases

Un		DC					AC (50 Hz) (1)		
Supply	(V)	24	48	110	125	220	120	230	
<b>Motor option</b>									
	(W)	200							
	(VA)							200	
	(s)	< 7						< 7	
<b>Opening releases</b>									
Shunt	(W)	200	250	300	300	300			
	(VA)							400	750
Undervoltage	Pick-up	(W)	160						
		(VA)							280
	Latched	(W)	4						
		(VA)							50
<b>Closing releases</b>									
Shunt	(W)	200	250	300	300	300			
	(VA)							400	750

(1) Please consult us for other frequencies.

Fuse ratings for MCset protection units depend, among other things, on the following criteria:

- Service voltage
- Transformer rating
- Fuse technology (manufacturer)

Different types of fuses with a medium loaded striker may be installed:

- **Solefuse**: fuses as per standard UTE NFC 64.210
  - **Fusarc CF**: fuses as per IEC recommendation 60.282.1 and DIN dimensions 43.625
- For a fuse-switch combination unit, refer only to the selection table and reference list of fuses. For all other type of fuses, consult us.

**Example:** for the protection of a 400 kVA transformer at 10 kV, select either **Solefuse** fuses rated 43 A or **Fusarc CF** fuses rated 50 A.

### Fuse selection table

Rating in A. No overload at  $-5^{\circ}\text{C} < t < 40^{\circ}\text{C}$ . Please consult us for overloads and operation over  $40^{\circ}\text{C}$  for France Transfo oil immersed type transformers.

Service voltage (kV)	Transformer rating (kVA)																	Rated voltage (kV)
	25	50	100	125	160	200	250	315	400	500	630	800	1000	1250	1600	2000	2500	
<b>Solefuse (UTE NFC standards 13.100, 64.210)</b>																		
5.5	6.3	16	31.5	31.5	63	63	63	63	63									7.2
10	6.3	6.3	16	16	31.5	31.5	31.5	63	63	63	63							
15	6.3	6.3	16	16	16	16	16	43	43	43	43	43	63					
20	6.3	6.3	6.3	6.3	16	16	16	16	43	43	43	43	43	63				24
<b>Solefuse (general case. UTE NFC standard 13.200)</b>																		
5.5	6.3	16	16	31.5	31.5	63	63	63	80	80	100	125						7.2
6.6	6.3	16	16	16	31.5	31.5	43	43	63	80	100	125	125					
10	6.3	6.3	16	16	16	31.5	31.5	31.5	43	43	63	80	80	100				12
13.8	6.3	6.3	6.3	16	16	16	16	16	31.5	31.5	31.5	43	63	63	80			17.5
15	6.3	6.3	16	16	16	16	16	16	31.5	31.5	31.5	43	43	63	80			
20	6.3	6.3	6.3	6.3	16	16	16	16	16	31.5	31.5	31.5	43	43	63			24
22	6.3	6.3	6.3	6.3	16	16	16	16	16	31.5	31.5	31.5	43	63	63			
<b>Fusarc CF and SIBA (1) (general case for QM, QMB and QMC cubicles according to IEC 62271-105)</b>																		
5	10	16	31.5	31.5	40	50	50	63	80	100	125	125						7.2
6	10	16	25	31.5	40	50	50	63	80	80	125	125						
6.6	10	16	25	31.5	40	50	50	63	80	80	100	125	125					
10	6.3	10	16	20	25	31.5	40	50	50	63	80	80	100	100				12
11	6.3	10	16	20	25	25	31.5	40	50	50	63	80	100	100				
13.8	6.3	10	16	16	20	25	31.5	31.5	40	50	50	63	80	80				17.5
15	6.3	10	10	16	16	20	25	31.5	40	50	50	63	80	80	100			
20	6.3	6.3	10	10	16	16	25	25	31.5	40	40	50	50	63	80	100 (1)	125 (1)	24
22	6.3	6.3	10	10	10	16	20	25	25	31.5	40	40	50	50	80	80	100 (1)	

(1) = SIBA fuses

### Fuses dimensions

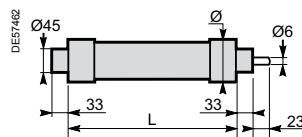
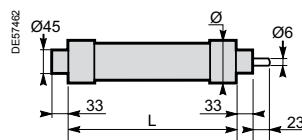
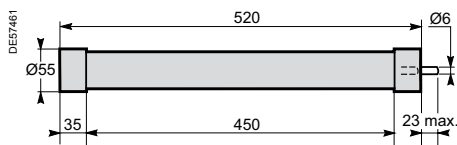

#### Solefuse (UTE standards)

Ur (kV)	Ir (A)	L (mm)	Ø (mm)	Weight (kg)
17.5 / 24	6.3 to 63	450	55	2

#### Fusarc CF

Ur (kV)	Ir (A)	L (mm)	Ø (mm)	Weight (kg)
17.5 / 24	6.3	442	50.5	1.6
	10	442	50.5	1.6
	16	442	50.5	1.6
	20	442	50.5	1.6
	25	442	57	2.2
	31.5	442	57	2.2
	40	442	57	2.2
	50	442	78.5	4.1
	63	442	78.5	4.1
80	442	86	5.3	

#### SIBA

Ur (kV)	Ir (A)	L (mm)	Ø (mm)	Weight (kg)
24	100	442	85	5.4
	125	442	85	5.4

# Installation

## Accessories and extraction withdrawable parts

### Extraction table

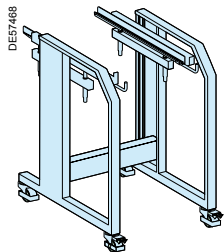

Adaptable to 3 cubicle widths, this extraction table enables:

- The withdrawable part to be removed from the cubicle
- The withdrawable part to be fitted into the cubicle

### Extraction and lowering tool - option

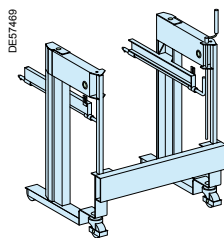

Adaptable to 3 cubicle widths, this extraction tool enables:

- The withdrawable part to be removed from the cubicle
- The withdrawable part to be introduced into the cubicle
- The withdrawable part to be lowered to the ground
- The withdrawable part to be lifted from the ground

### Racking handle

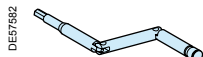

This handle enables:

- The withdrawable part to be racked in/out
- The earthing switch to be open/closed

### Marine application (up to 17.5 kV) - Extraction and lowering tool - option

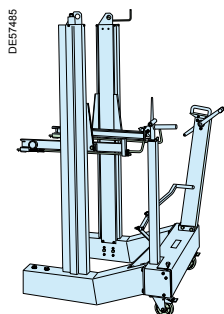

Adaptable to 3 cubicle widths, this extraction tool enables:

- The withdrawable part to be removed from the cubicle
- The withdrawable part to be introduced into the cubicle
- The withdrawable part to be lowered to the ground
- The withdrawable part to be lifted from the ground

# Installation

## Implementation examples

### MCset 17.5 kV line-up switchboard

**Line-up switchboard**  
(2 supplies cubicles and 1 bussection)

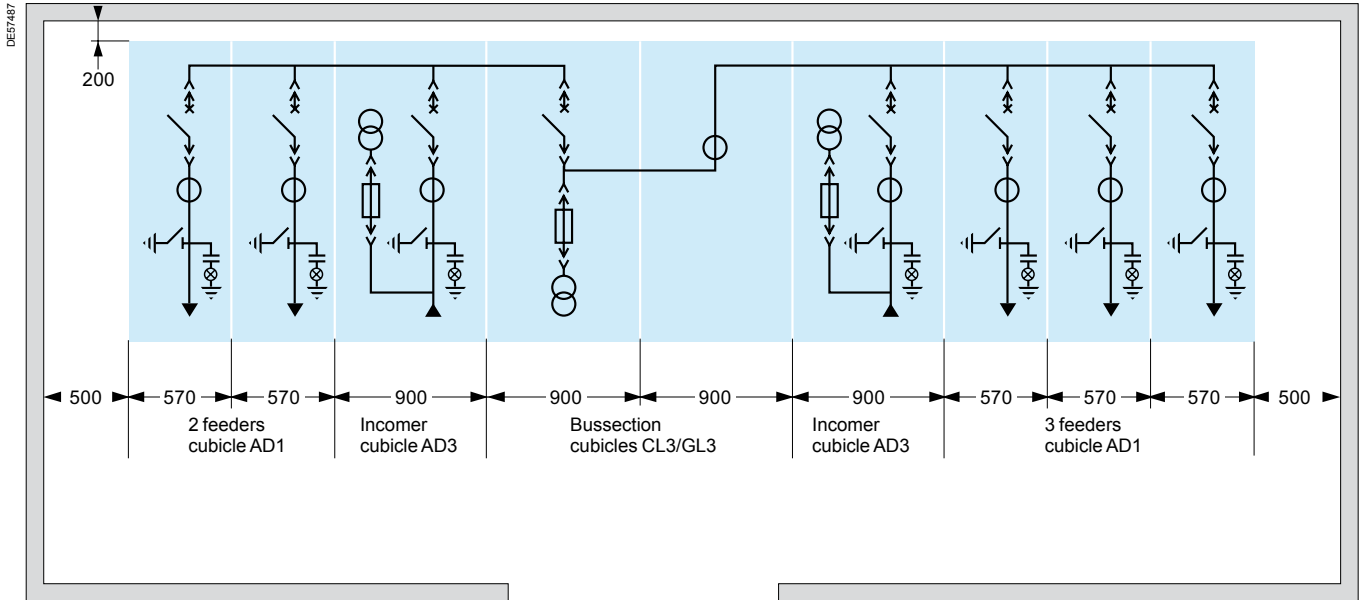

**Civil engineering with utility space**

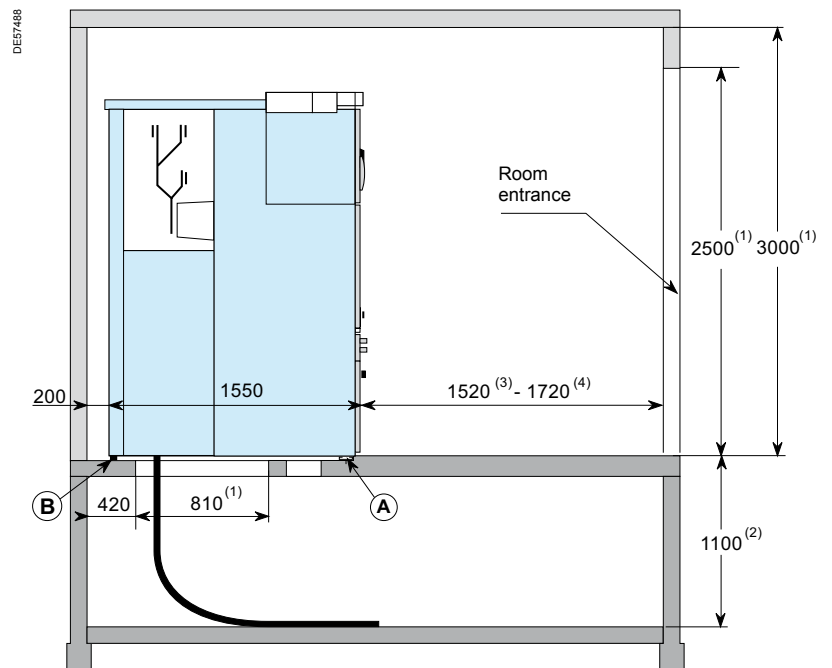

- (1) Minimum dimensions to be complied with when installing the MCset switchboard.
- (2) Minimum dimensions to be defined according to the cable bending radius.
- (3) Operating distance.
- (4) Distance needed to extract a functional unit from the switchboard without moving the other units.

**A** anchor point  
**B** adjustment point

Note: for further information, refer to the civil engineering guide, and the user and instruction manual.



# Installation

## Implementation examples

### MCset 24 kV line-up switchboard

**Line-up switchboard**  
(2 supply cubicles and 1 bussection at 24 kV)

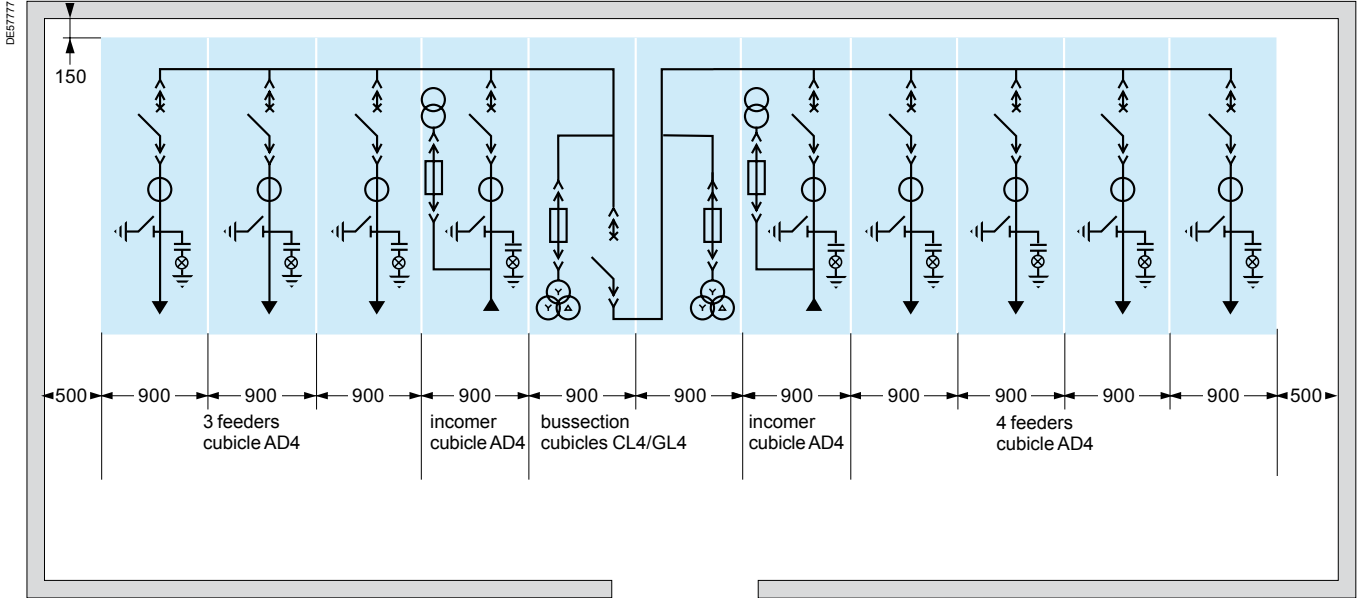

**Civil engineering with utility space**

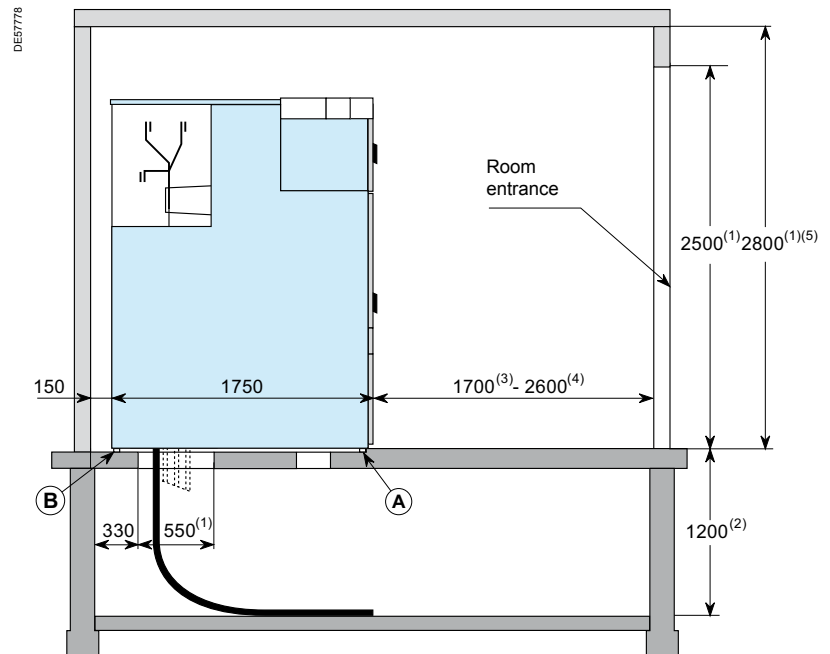

- (1) Minimum dimensions to be complied with when installing the MCset switchboard.
- (2) The cable basement or cable trench depth can be reduced if it is compatible with the bending radius of the cables used.
- (3) Operating distance.
- (4) Distance needed to extract a functional unit.
- (5) Provide an exhaust tunnel above the switchboard when the room height is less than 4 metres (see page E-9).

**A** anchor point  
**B** adjustment point

Note: for further information, refer to the civil engineering guide, and the user and instruction manual.

# Installation

## Implementation examples

### MCset 17.5 kV / Motorpact transition switchboard

**Transition switchboard**  
(2 supply cubicles and 1 bussection)

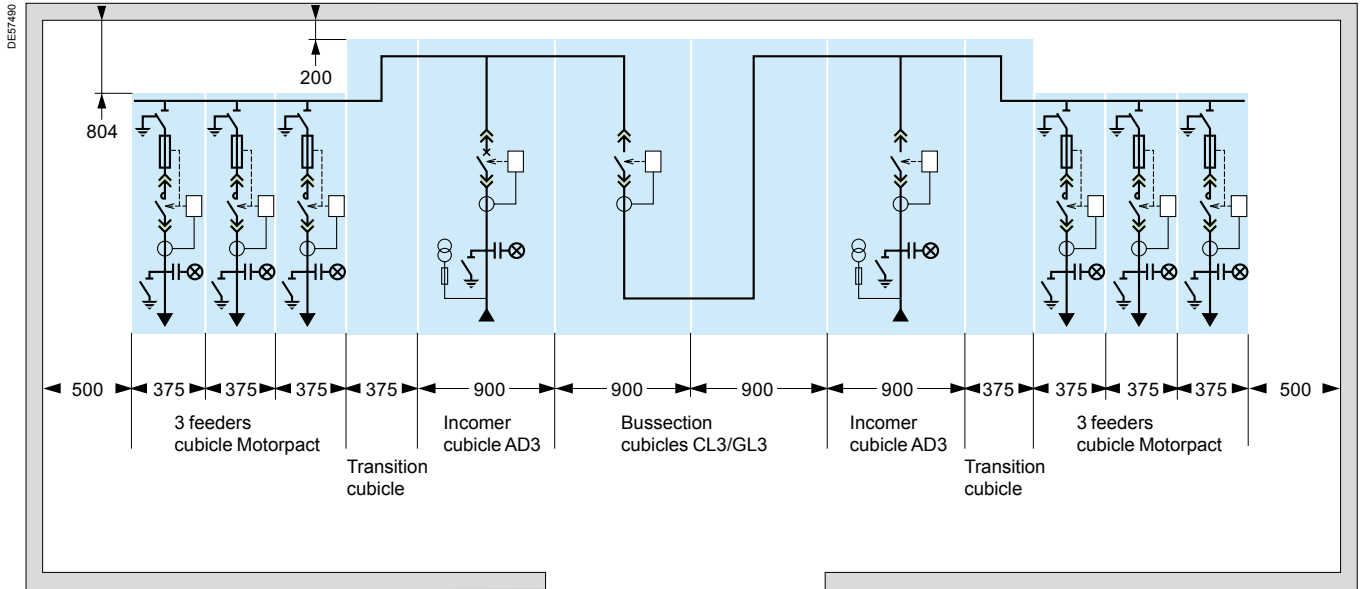

**Civil engineering with utility space**

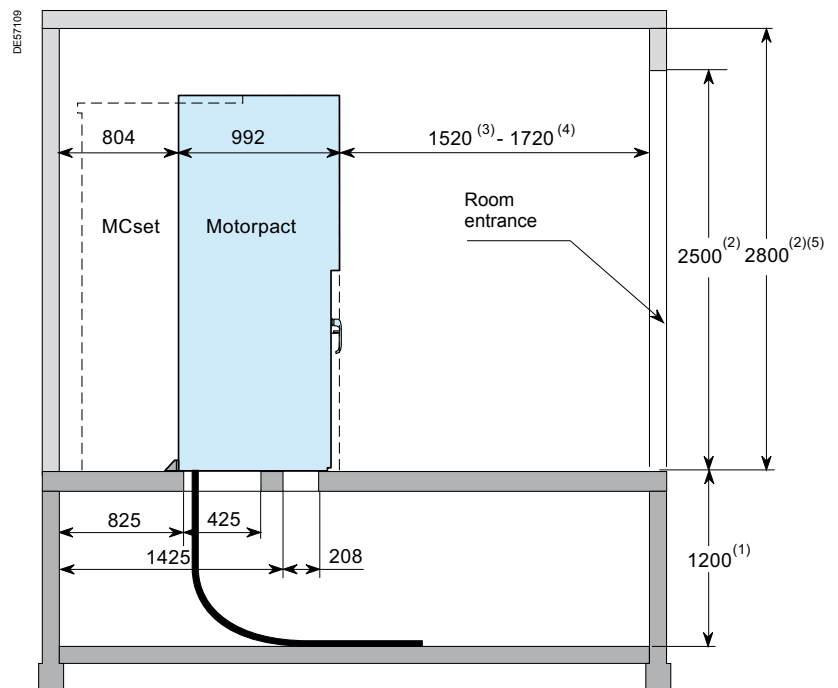

(1) Minimum dimensions to be defined according to the cable bending radius.

**Note for lined up switchboard with MCset**

(2) Minimum dimensions to be complied with when installing the MCset switchboard.

(3) Operating distance.

(4) Distance needed to extract a functional unit from the switchboard without moving the other units.

(5) Provide an exhaust tunnel above the switchboard when the room height is less than 4 metres (see page E-9).

Note: for further information, refer to the civil engineering guide, and the user and instruction manual.

E72501R



## Switchgear resistance to ageing in a substation depends on 3 key factors

### ■ The need for correctly performed connections

New cold connecting technologies offer easy installation and favour durability in time. Their design means they can be used in polluted environments with harsh atmospheres.

### ■ The impact of relative humidity

The installation of a heating element is essential in climates with high relative humidities and significant temperature differentials.

### ■ Ventilation control

The dimensions of air vents must be appropriate for the dissipated energy in the substation. They must only sweep across the transformer environment.

### Cold connected terminals

Schneider Electric's experience has led it to favour this technology wherever possible for optimum durability.

The maximum acceptable cable cross-section for standard assemblies are:

- 630 mm<sup>2</sup> for incomer or feeder cubicles with single-pole cables
- 400 mm<sup>2</sup> for incomer or feeder cubicles with three-pole cables
- 95 mm<sup>2</sup> for transformer protection cubicles with fuses

Access to the compartment is only possible when the earthing switch is closed. The cable torques is to be done using a dynamo wrench set to 50 mN.

## Dry, single pole cable

### Short end piece, cold connectable

<b>Performance</b>	3 to 24 kV - 400 A - 2500 - 3150 A - 4000 A
<b>Cross section mm<sup>2</sup></b>	50 to 630 mm <sup>2</sup>
<b>Supplier</b>	All suppliers of cold connectable terminals: Silec, 3M, Pirelli, Raychem, etc.
<b>Number of cables</b>	1 to 8 per phase
<b>Comments</b>	For a greater cross-section and number of cables, please consult us

## Dry, three-pole cable

### Short end piece, cold connectable

<b>Performance</b>	3 to 24 kV - 400 A - 2500 - 3150 A - 4000 A <sup>(2)</sup>
<b>Cross section mm<sup>2</sup></b>	50 to 240 mm <sup>2</sup>
<b>Supplier</b>	All suppliers of cold connectable terminals: Silec, 3M, Pirelli, Raychem, etc.
<b>Number of cables</b>	1 to 4 per phase
<b>Comments</b>	For a greater cross-section and number of cables, please consult us

## Connection possibilities using dry cables

Number of cables	AD1	AD1 contactor	AD2	AD3	DI2	AD4	RD4	DI4
1 single per phase	■ (1)	■ (1)	■ (1)		■	■ (1)	■	■
2 single per phase	■ (1)	■ (1)	■ (1)	■		■ (1)	■	
3 single per phase	■	■	■	■		■	■	
4 single per phase				■		■	■	
1 three per cubicle	■	■	■			■	■	
2 three per cubicle	■	■	■	■		■	■	
3 three per cubicle	■	■	■	■		■	■	
4 three per cubicle				■		■	■	

(1) Possibility of installing LV toroid transformers.

(2) Please consult us.

### Bottom cable connection

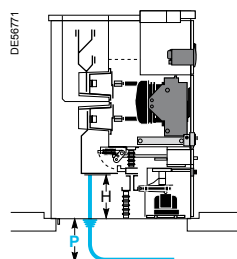

Figure 1

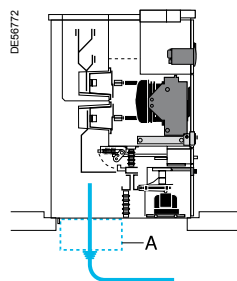

Figure 2

#### Cable connection height

Type of cubicle	Configuration	H (mm)	
AD1 - AD2	630 A	LV toroid CT	621 (1)
		1 set of 3 CT's	454
		2 sets of 3 CT's	438
	1250 A	LV toroid CT	621 (1)
		1 set of 3 CT's	454
		2 sets of 3 CT's	438
AD3	1250 A	1 set of 3 CT's	477
		2 sets of 3 CT's	459
	2500 A	1 set of 3 CT's	428
		2 sets of 3 CT's	428
	3150 A	1 set of 3 CT's	404
3600/4000 A	1 set of 3 CT's	653	
AD4 - RD4	630 A	LV core balance CT	530
		630 to 2500 A	1 set of 3 CT's
		2 sets of 3 CT's	410
D12			450
D14			650

(1) When installing a LV core balance CT, use a type ARC3 LV core balance CT when connecting with 2 cables (see page E-12).

- The cubicles and cables requiring the maximum depth should be taken into consideration when determining the depth **P** of a switchboard cable duct (figure 1)
- For reconstructed cables of length exceeding 460 mm, provide for the installation of an additional compartment under the cubicle (ref. A, figure 2)

### Top cable connection (optional, figure 3)

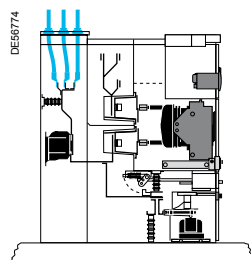

Figure 3

2 depths are available, function of the number of cables and the internal arc withstand of the cubicle: 2000 mm and 2275 mm.

### Top busbar connection (optional, figure 4)

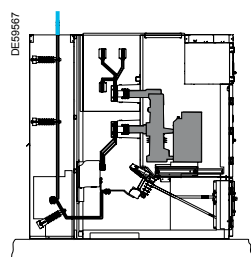

Figure 4

Up to 17.5 kV, the cubicle depth is equal to 2000 mm and can be equipped with 1 or 2 CT's. For a standard 24 kV cubicle, the additional depth is 500 mm. Rated current In: 1250 A and 2500 A.

Equipment			Type of cubicle													
			AD1 RD1	AD1 cont.	AD2 RD2	AD3 RD3	CL1	CL2	CL3	GL1	GL2	GL3	TT1	TT2	DI2	
<b>Switchgear</b>																
Circuit-breaker			■		■	■	■	■	■							
Contactors				■												
Fuse switch															■	
Disconnecter truck			□		□	□	□	□	□							
Earthing truck			□	□	□	□	□	□	□							
Fixed busbars										■	■	■	■	■		
Racking position indication contact for the withdrawable part	6 NO + 6 NC		■		■	■	■	■	■							
Padlocking of isolating shutters for withdrawable parts			□	□	□	□	□	□	□							
Locking of the withdrawable part/cable compartment			□	□	□	□	□	□	□							
Disabling of the circuit-breaker operating mechanism			□		□	□	□	□	□							
Voltage present indicator			■	■	■	■	□	□	□			■ (1)	■ (1)	■		
Locking of the mechanical racking of the withdrawable part (padlock)			■	■	■	■	■	■	■							
Locking of the mechanical racking of the withdrawable part (keylock)			□	□	□	□	□	□	□							
Locking of the electromagnetic racking of the withdrawable part			□	□	□	□	□	□	□							
<b>Earthing switch (SMALT)</b>																
Earthing switch			□	□	□	□	□	□	□			□	□	■		
Earthing switch position indication contacts	3 NO + 3 NC		□ (1)	□ (1)	□ (1)	□ (1)	□ (1)	□ (1)	□ (1)			□ (1)	□ (1)	□ (4)		
Earthing switch position key locking			□ (1)	□ (1)	□ (1)	□ (1)	□ (1)	□ (1)	□ (1)			□ (1)	□ (1)	□		
Electromagnetic earthing switch position locking			□	□	□	□	□	□	□			□	□			
<b>Transformers</b>																
Voltage Transformers (1 per phase)	Without fuse	Phase-phase			□	□		□	□		□	□		□		
		Phase-earth	□		□	□	□	□	□	□	□	□	□	□	□	
	With plug-in fuses	Phase-phase			□	□		□ (8)	□ (8)		□	□		□		
		Phase-earth	□		□	□	□ (8)	□ (8)	□ (8)	□	□	□	□	□	□	
Fuse melting indication contact		1 NO	□		□	□	□	□	□	□	□	□	□	□		
Current Transformer	Single set	3 CT's	□	□	□	□	□	□	□	□	□	□	□	□		
	Double set	6 CT's	□	□	□	□										
	LV toroid transformer CT (3)		□	□	□											
	LPCT		□	□	□	□	□	□	□							
<b>Connections</b>																
Connection with cable terminal height > 460 mm			□	□	□	□									□	
Connection from top bar			□	□	□	□										
Connection by cable from the top			□	□	□	□										
Connection by cable from the bottom			■	■	■	■									■	
<b>Cubicle</b>																
Protection index (7)	Enclosure	IP3X	■	■	■	■	■	■	■	■	■	■	■	■	■	■
		IP4X	■	■	■	■	■	■	■	■	■	■	■	■	■	■
		IPX1	□	□	□	□	□	□	□	□	□	□	□	□	□	□
	Compartments (5)	IPX2	□	□	□	□	□	□	□	□	□	□	□	□	□	□
		IP2XC	■	■	■	■	■	■	■	■	■	■	■	■	■	■
Anti-arcing protection (2)		25 kA - 1 s	□	□	□	□	□	□	□	□	□	□	□	□	□	
		31.5 kA - 1 s	□	□	□	□	□	□	□	□	□	□	□	□	□	
		40 kA - 1 s		□	□	□		□	□		□	□		□		
		50 kA - 1 s		□	□	□		□	□		□	□		□		
Thermal diagnosis system (7)			□	□	□	□										
Lightning arrester			□	□	□	□				□	□	□	□			
<b>Busbars</b>																
1250 A / 2500 A / 3150 A / 4000 A (6)	Exposed		■	■	■	■	■	■	■	■	■	■	■	■	■	
	Insulated		□	□	□	□	□	□	□	□	□	□	□	□	□	
LV control cabinet key locking			□	□	□	□	□	□	□	□	□	□	□	□	□	
LV control cabinet lighting			□	□	□	□	□	□	□	□	□	□	□	□	□	
Anti-condensation heating element			□	□	□	□	□	□	□	□	□	□	□	□	□	

■: basic equipment.

□: option.

(1) Basic equipment with earthing switch option.

(2) According to the room in which the MCset switchboard is installed, you can choose an option for 3 or 4 sides, and possibly an exhaust tunnel for hot gases (see page E-9).

(3) Connection 1 or 2 cables per phase.

(4) 1 NO + 1 NC available.

(5) Compartment protection.

(6) For 4000 A/95 kV impulse: insulated busbar compulsory.

(7) Consult us.

(8) Not possible with the "earthing switch" option.



Equipment			Type of cubicle					
			AD4	RD4	CL4	GL4	TT4	DI4
<b>Switchgear</b>								
		Circuit breaker	■		■			
		Pressure switch	□		□			
		Fuse switch						■
		Disconnecter truck	□		□			
		Earthing truck	□		□			
		Fixed busbar		■				
		Racking position indication contact for the withdrawable part 6 NO + 6 NC	■		■			
		Padlocking of isolating shutters for withdrawable parts	□		□			
		Locking of withdrawable part/cable compartment	■					
		Disabling of circuit breaker operating mechanism	■		■			
		Voltage presence indicator	□ (3)	□ (3)	□ (3)		■ (3)	■
<b>Earthing switch (SMALT)</b>								
		Earthing switch	□	□			□	■
		Earthing switch position indication contacts 2 NO + 2 NC	□ (1)	□ (1)			□ (1)	□ (7)
		Earthing switch position key locking	□ (1)	□ (1)			□ (1)	□
		Electromagnetic earthing switch position locking	□	□			□	
<b>Transformers</b>								
Voltage Transformers	Fixed VT without fuse	Phase-phase (1 or 2 per cubicle)	□	□	□	□	□	
		Phase-earth (1 per phase)	□	□	□	□	□	
	With plug-in fuses	Phase-earth	□	□	□	□	□	
Current Transformer	Single set	3 TC	□	□	□	□		
		Double set	□					
		LV core balance CT (4)	□ (6)	□ (6)				
<b>Connections</b>								
		Connection with cable terminal height > 430 mm (MCset 4)	□	□				□
		Connection from top bar	□	□				
		Connection by cable from the bottom	■	■				■
		Connection by cable from the top	□	□				
<b>Cubicle</b>								
Protection index	Enclosure	IP3X	■	■	■	■	■	■
		IP4X	□	□	□	□	□	□
		IPX1 (8)	□	□	□	□	□	□
	Compartments (9)	IP2XC	■	■	■	■	■	■
Anti-arcing protection (2)	25 kA - 1 s		□	□	□	□	□	□
		31.5 kA - 0.15 s	□	□	□	□	□	□
		Lightning arrester	□	□			□	
<b>Busbars</b>								
		1250 A, 2500 A Insulated	■	■	■	■	■	■
<b>LV control cabinet</b>								
		LV control cabinet key locking	□	□	□	□	□	□
		LV control cabinet lighting (220 V AC/127 V DC)	□	□	□	□	□	□
		Anti-condensation heating element (220 V AC/127 V DC)	■	■		■	■	■

■: basic equipment.

□: option.

(1) Basic equipment with earthing switch option.

(2) According to the room in which the MCset switchboard is installed, you can choose AFL or AFLR, and possibly an exhaust tunnel for hot gases (≥ 4 m and ≤ 4 m).

(3) Basic equipment when the cubicle is equipped with an earthing switch.

(4) Connection 1 or 2 cables per phase.

(5) Possibility of 1 phase-phase VT.

(6) Only for 630 A cubicle.

(7) 1 NO + 1 NC available.

(8) For IPX2, consult us.

(9) Compartment protection.

---

Air Insulated Switchgear up to 24 kV  
PIX switchgear -  
Vacuum circuit breaker



<b>Description</b>	<b>D-2</b>
<b>Technical characteristics</b>	<b>D-3</b>
<b>Functions and characteristics</b>	
Choice of functional units	<b>D-4</b>
CB type cubicles	<b>D-6</b>
T1 type cubicles	<b>D-7</b>
BC-CB type cubicles	<b>D-8</b>
RMT type cubicles	<b>D-9</b>
MT BBE type cubicles	<b>D-10</b>
Motor Control Center	<b>D-11</b>
<b>Switchgear / Apparatus</b>	
PIX design	<b>D-12</b>
HVX circuit breaker	<b>D-14</b>
CVX contactor	<b>D-16</b>
L-TRI air switch disconnecter	<b>D-17</b>
<b>Installation</b>	
Accessories and extraction withdrawable parts	<b>D-18</b>
Implementation examples	<b>D-19</b>
Connections	<b>D-20</b>
<b>Cubicle equipment</b>	<b>D-22</b>

## Structure of a PIX switchboard

PIX switchboards are made up of several interconnected functional units.

Power connections are made between the functional units within a switchboard via a single busbar.

The electrical continuity of all of the metal frames is provided by the connection of each functional unit's earthing busbar to the switchboard's main earthing circuit.

Low voltage wiring trays are provided in the switchboard above the low voltage control cabinets.

LV cables can enter the switchboard through the top or bottom of each functional unit.

## Description of a functional unit

A functional unit consists of all of the equipment in the main and auxiliary circuits which together provide a protection function. Each functional unit combines all of the components which are required to fulfil this function:

- The cubicle, and
- The protection, monitoring and control system (including the withdrawable live part)

## Accessibility of the MV compartments

### Interlock-controlled accessible compartment:

- Withdrawable MV part (circuit breaker, contactor) compartment

### Tool-based accessible compartments:

- Cable compartment
- Busbar compartment
- Fixed parts compartment

## The protection, monitoring and control system

This includes:

- The Sepam, MiCOM, protection, monitoring and control unit
- The GemControl monitoring and control unit
- The Vamp arc flash protection system
- Current sensors, which may be of 3 types,
  - a conventional Current Transformer
  - toroid type Current Transformers
  - LPCT type Current Transformers
- Voltage Transformers, and
- Zero sequence core balance Current Transformers (CSH type).

## The cubicle

The cubicle is a LSC2B (Loss of Service Continuity Category) type as defined by IEC standard 62271-200; in other words, the medium voltage parts are compartmented using metal partitions (PM class) which are connected to earth and which separate:

- The busbars
- The withdrawable part (circuit-breaker, fuse-contactor, disconnecter truck or earthing truck), and
- The MV connections, earthing switch, current sensors and Voltage Transformers, as required

PIX guarantees a high level of protection of people; when a compartment containing a main circuit is open, the other compartments and/or functional units may remain energised.

The low voltage auxiliaries and monitoring unit are in a control cabinet separated from the medium voltage section.

### Four basic cubicle layouts are offered:

- |                                |                |
|--------------------------------|----------------|
| ■ Incomer or feeder            | <b>CB</b>      |
| ■ Fuse-switch feeder           | <b>T1</b>      |
| ■ Line-up bussection           | <b>BC - CB</b> |
| ■ Busbar metering and earthing | <b>MT BBE</b>  |

## The withdrawable part

The withdrawable function gives the ability to disconnect devices.

It includes:

- The circuit breaker, contactor, or the earthing truck
- The propulsion mechanism for racking in and racking out, and
- Interlocks to fix the withdrawable part either in a service or disconnecting position



- 1 - Busbars
- 2 - Withdrawable part
- 3 - Current Transformers
- 4 - Cables connection
- 5 - LV control cabinet
- 6 - Sepam or MiCOM relay
- 7 - Voltage Transformers



### LSC2B

(Loss of Service Continuity IEC 62271-200):

this category defines the possibility of keeping other compartments energised (in service) when opening a main circuit compartment.



PE69243



Rated voltage					
	<b>Ur</b> (kV)	<b>12</b>	<b>17.5</b>	<b>24</b>	
Rated insulation level					
Power frequency withstand voltage 50 Hz - 1 min	<b>Ud</b> (kV rms)	28	38	50	
Lightning impulse withstand voltage 1.2/50 $\mu$ s	<b>Up</b> (kV peak)	75	95	125	
Rated normal current and maximum short time withstand current (1)					
Peak withstand current Ip (kA)	(kA rms)	63/80/100/130		50/63/80	
Functional unit with circuit breaker					
Short time withstand current	<b>Ik/tk</b> (kA/3 s)	25	25	20	
		31.5	31.5	25	
		40	40	31.5	
		50	50		
Rated current	<b>Ir max. busbar</b>	<b>Ir</b> (A)	up to 3150 up to 5000 (2)		
Rated current	<b>Ir CB</b>	<b>Ir</b> (A)	1250	1250	1250
			2500	2500	2500
			3150	3150	
			4000 (2)	4000 (2)	
			5000 (2)	5000 (2)	
Functional unit with switch disconnector					
Rated current	(A)	630	630	630	
Functional unit with switch-fuse combination (T1 cubicle) (3)					
Rated current	(A)	400	400	400	
Functional unit with fuse contactor					
Rated current	(A)	200-400			
Internal arc classification (maximum value $I_A$ and $t_A$ )					
	(kA/1 s)	50	50	31.5	
	IAC	AFLR	AFLR	AFL	
Degree of protection					
External enclosure	Standard	IP3X			
	Option	IP4X			



**IAC (internal arc classification):**  
The metal enclosed switchgear may have different types of accessibility on the various sides of its enclosure.  
For identification purposes concerning the different sides of the enclosure, the following code shall be used (according to the IEC 62271-200 standard):  
A: restricted access to authorised personnel only  
F: access to the front side  
L: access to the lateral side  
R: access to the rear side.

(1) For functional units equipped with circuit breakers or fuse-contactors, the breaking capacity is equal to the short time withstand current. In all cases, the device peak making capacity is equal to 2.5 times the short time withstand current.  
(2) With fan.  
(3) According to IEC 62271-105, combinations do not have a rated short time withstand current.



# Functions and characteristics

## Choice of functional units

PIX has a comprehensive range of functions to suit all requirements for a lot of applications.

**Selection guide:**

The following guide will help you to define the most appropriate protection corresponding to the type of applications you want to energize. The equipments shown below are the main functions.

Additional functions is available upon request to answer specific requirements.

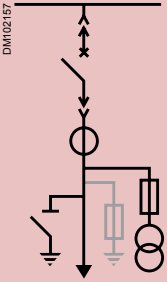
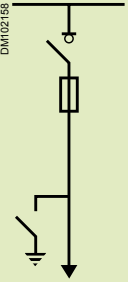
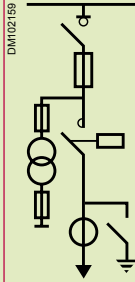
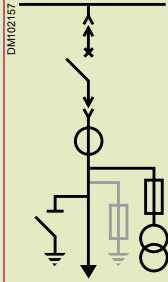
Function	Incomer / Feeder			Feeder		
	Line	Transformer	Generator	Transformer	Motor	Capacitor
<b>Cubicle</b>	<b>CB</b>	<b>CB</b>	<b>CB</b>	<b>T1</b>	<b>MCC</b>	<b>CB</b>
Device	Circuit breaker	Circuit breaker	Circuit breaker	Fuse-switch	Fuse contactor	Circuit breaker
Protection application	Substation	Transformer	Generator	Transformer	Motor	Capacitor
<b>Single line diagrams</b>						

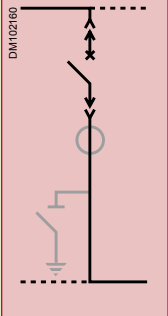
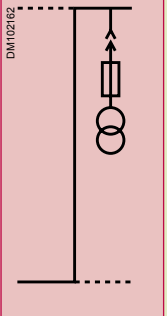
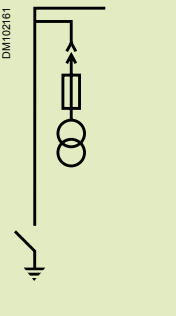
Bussectioning		Metering and busbar earthing
Switchboard	Switchboard	
<b>BC CB</b>	<b>RMT</b>	<b>MT BBE</b>
		



# Functions and characteristics

## CB type cubicles

### Incomer or feeder

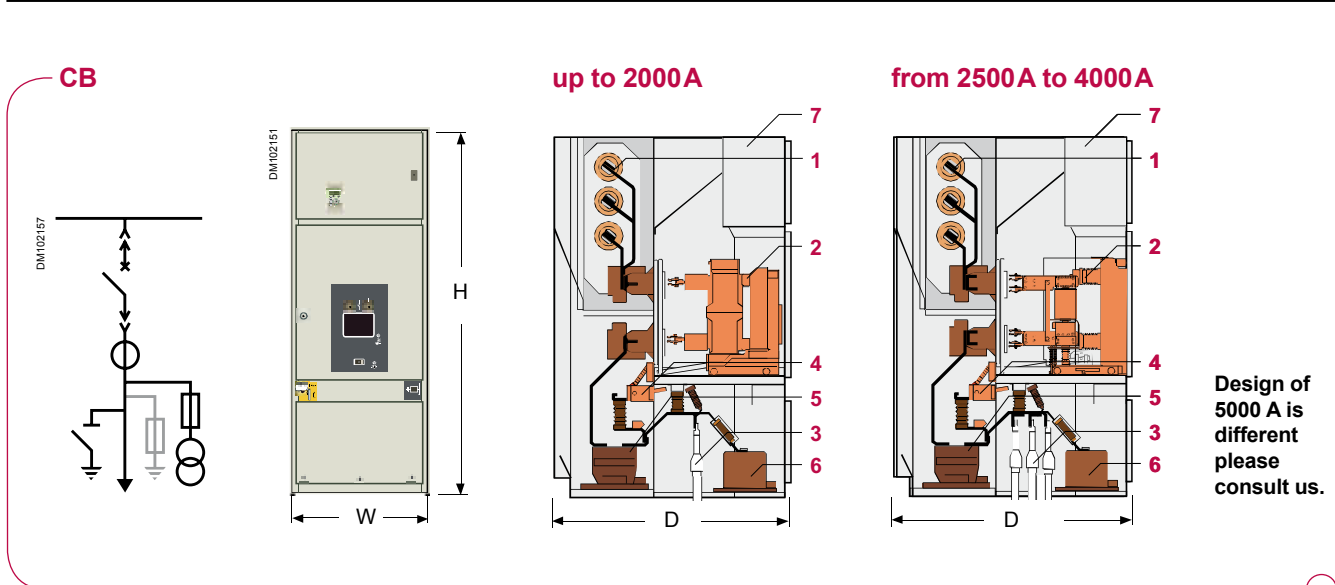

#### MV devices

- 1 Busbars for cubicle interconnection
- 2 Main switching device
- 3 MV connections by cables accessible from the front face
- 4 Earthing switch
- 5 Current sensors
- 6 Voltage Transformers

#### LV control cabinet

- 7 Low voltage auxiliaries and the protection, monitoring and control unit are in a control cabinet which is separated from the medium voltage part

#### Options

- VT's with fuses
- Withdrawable cable VT's with removable fuses
- Fixed VT's without fuses
- Surge arresters
- Earthing switch motorisation

### Characteristics

		CB 12				CB 17				CB 24			
<b>Rated voltage</b>	kV	12				17.5				24			
<b>Breaking capacity</b>	kA	25	31.5	40	50	25	31.5	40	50	25	31.5		
<b>Rated current</b>	A												
Vacuum circuit breaker	630	■ (1)	■ (1)	■ (1)	■ (3)	■ (2)	■ (2)	■ (2)	■ (3)	■ (3)	■ (3)		
	1250	■ (1)	■ (1)	■ (1)	■ (3)	■ (2)	■ (2)	■ (2)	■ (3)	■ (3)	■ (3)		
	1600	■ (3)	■ (3)	■ (3)	■ (3)	■ (2)	■ (2)	■ (2)	■ (3)	■ (3)	■ (3)		
	2000	■ (3)	■ (3)	■ (3)	■ (3)	■ (2)	■ (2)	■ (2)	■ (3)	■ (4)	■ (4)		
	2500	■ (4)	■ (4)	■ (4)	■ (3) (4)	■ (4)	■ (4)	■ (4)	■ (3) (4)	■ (4)	■ (4)		
	3150	■ (4)	■ (4)	■ (4)	■ (4)	■ (4)	■ (4)	■ (4)	■ (4)				
	4000 (*)	■ (4)	■ (4)	■ (4)	■ (4)	■ (4)	■ (4)	■ (4)	■ (4)				
5000 (*)	■ (4)	■ (4)	■ (4)	■ (4)	■ (4)	■ (4)	■ (4)	■ (4)					
Short-circuit making current $I_p$	Peak value kA	50 Hz	63	80	100	100 / 125 (**)	63	80	100	100 / 125 (**)	63	80	
		60 Hz	65	80	104	100 / 125 (**)	65	80	104	100 / 125 (**)	65	82	
Duration	s	3	3	3	3	3	3	3	3	3	3		
Dimensions	mm	H	2130			2330 (***)			2200		2330 (***)		2330
		D	1405		1605	1590	1505	1605		1590	1605/1805		
Approximate mass	kg	820			Max. 1900			850		Max. 1900		870	

(\*) With forced ventilation for 4000 A and 5000 A.

(\*\*) Higher values on request.

(\*\*\*) With LV cabinet 2330 mm, with fan 2800 mm, with gas duct 3100 mm.

(1) Width: 650 mm. (2) Width: 750 mm. (3) Width: 800 mm. (4) Width: 1000 mm.

# Functions and characteristics

## T1 type cubicles

### Fuse-switch feeder

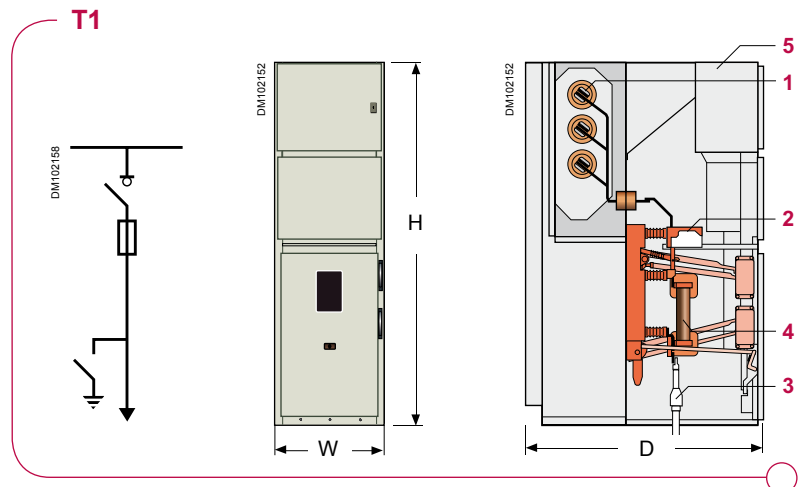

#### MV devices

- 1 Busbars for cubicle interconnection
- 2 Switch disconnecter
- 3 MV connections by cables accessible from the front face
- 4 Fuses

#### LV control cabinet

- 5 Low voltage auxiliaries and the protection, monitoring and control unit are in a control cabinet which is separated from the medium voltage part

### Characteristics

				T1 12	T1 17	T1 24	
<b>Rated voltage</b>			kV	12	17.5	24	
<b>Insulation level</b>	Insulation	<b>Ud</b>	50/60 Hz - 1 min	kV rms	28	38	50
	Insulation	<b>Ud</b>	50/60 Hz - 1 min	kV rms	32	45	60
	Insulation	<b>Up</b>	1.2/50 $\mu$ s	kV peak	75	95	125
	Insulation	<b>Up</b>	1.2/50 $\mu$ s	kV peak	85	110	145
<b>Rated current</b>		A					
With fuses				200	■	■	
Without fuses				630	■	■	
Short-circuit making current	<b>Ip</b>	Peak value kA	50 Hz	63	63	63	
			60 Hz	63	63	63	
Dimensions		mm	H	2130	2200	2330	
			W	650	750	800	
			D	1405/1605	1505/1605	1605/1805	
Approximate mass			kg	600	650	750	

# Functions and characteristics

## BC CB type cubicles

### Line-up bussectioning

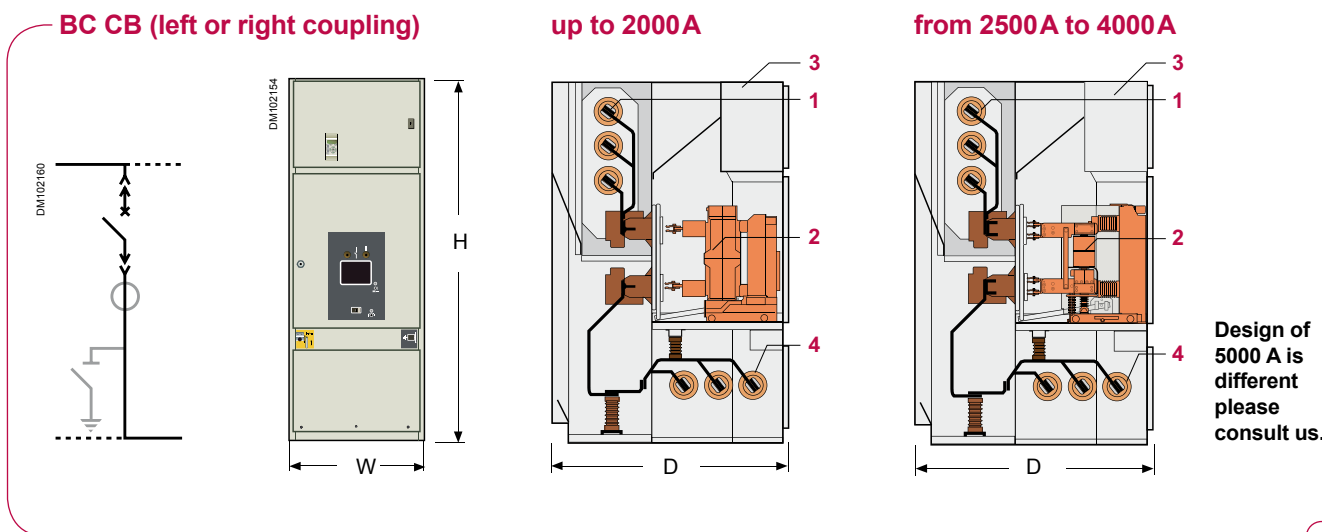

#### MV devices

- 1 Busbars for cubicle interconnection
- 2 Main switching device
- 4 Busbars for cubicle interconnection with bus riser (right or left coupling)

#### LV control cabinet

- 3 Low voltage auxiliaries and the protection, monitoring and control unit are in a control cabinet which is separated from the medium voltage part

### Characteristics

			BC CB 12				BC CB 17				BC CB 24	
Rated voltage	kV		12				17.5				24	
Breaking capacity	kA		25	31.5	40	50	25	31.5	40	50	25	31.5
Rated current	A											
Vacuum circuit breaker		630	■ (1)	■ (1)	■ (1)	■ (3)	■ (3)	■ (3)	■ (3)	■ (3)	■ (3)	■ (3)
		1250	■ (1)	■ (1)	■ (1)	■ (3)	■ (3)	■ (3)	■ (3)	■ (3)	■ (3)	■ (3)
		1600	■ (3)	■ (3)	■ (3)	■ (3)	■ (3)	■ (3)	■ (3)	■ (3)	■ (3)	■ (3)
		2000	■ (3)	■ (3)	■ (3)	■ (3)	■ (3)	■ (3)	■ (3)	■ (3)	■ (4)	■ (4)
		2500	■ (4)	■ (4)	■ (4)	■ (3) (4)	■ (4)	■ (4)	■ (4)	■ (3) (4)	■ (4)	■ (4)
		3150	■ (4)	■ (4)	■ (4)	■ (4)	■ (4)	■ (4)	■ (4)	■ (4)		
		4000 (*)	■ (4)	■ (4)	■ (4)	■ (4)	■ (4)	■ (4)	■ (4)	■ (4)		
	5000 (*)	■ (4)	■ (4)	■ (4)	■ (4)	■ (4)	■ (4)	■ (4)	■ (4)			
Short-circuit making current I <sub>p</sub>	Peak value kA	50 Hz	63	80	100	100 / 125 (**)	63	80	100	100 / 125 (**)	63	80
		60 Hz	65	80	104	100 / 125 (**)	65	80	104	100 / 125 (**)	65	82
	s	Duration	3	3	3	3	3	3	3	3	3	3
Dimensions	mm	H	2130			2330 (***)	2200			2330 (***)	2330	
		D	1405		1605	1590	1505		1605	1590	1605/1805	
Approximate mass	kg	820			Max. 1900		850		Max. 1900		870	

(\*) With forced ventilation for 4000 A and 5000 A.

(\*\*) Higher values on request.

(\*\*\*) With LV cabinet 2330 mm, with fan 2800 mm, and gas duct 3100 mm.

(1) Width: 650 mm. (2) Width: 750 mm. (3) Width: 800 mm. (4) Width: 1000 mm.

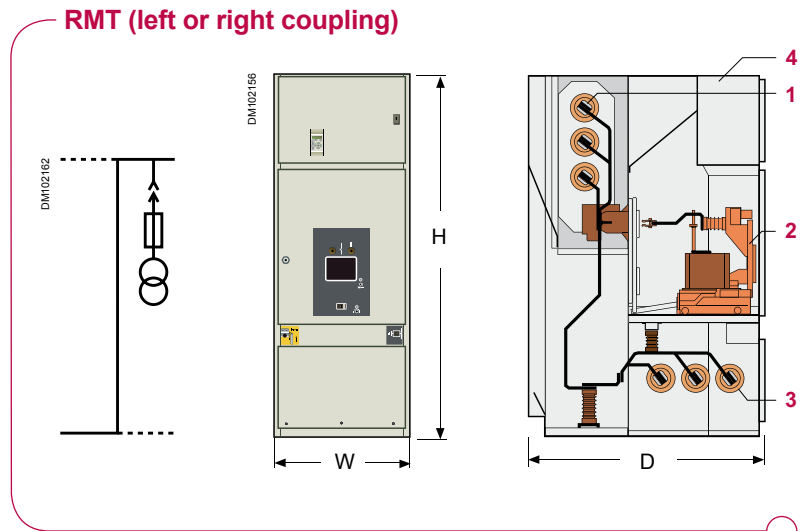

#### MV devices

- 1 Busbars for cubicle interconnection
- 2 Withdrawable Voltage Transformer
- 4 Busbars for cubicle interconnection with bus riser (right or left coupling)

#### LV control cabinet

- 3 Low voltage auxiliaries and the protection, monitoring and control unit are in a control cabinet which is separated from the medium voltage part

#### Options

- Voltage Transformers

## Characteristics

		RMT 12				RMT 17				RMT 24	
Rated voltage	kV	12				17.5				24	
Breaking capacity	kA	25	31.5	40	50	25	31.5	40	50	25	31.5
Rated current	A										
Vacuum circuit breaker	630	■ (1)	■ (1)	■ (1)	■ (3)	■ (2)	■ (2)	■ (2)	■ (3)	■ (3)	■ (3)
	1250	■ (1)	■ (1)	■ (1)	■ (3)	■ (2)	■ (2)	■ (2)	■ (3)	■ (3)	■ (3)
	1600	■ (3)	■ (3)	■ (3)	■ (3)	■ (2)	■ (2)	■ (2)	■ (3)	■ (3)	■ (3)
	2000	■ (3)	■ (3)	■ (3)	■ (3)	■ (2)	■ (2)	■ (2)	■ (3)	■ (4)	■ (4)
	2500	■ (4)	■ (4)	■ (4)	■ (3) (4)	■ (4)	■ (4)	■ (4)	■ (3) (4)	■ (4)	■ (4)
	3150	■ (4)	■ (4)	■ (4)	■ (4)	■ (4)	■ (4)	■ (4)	■ (4)		
	4000 (*)	■ (4)	■ (4)	■ (4)	■ (4)	■ (4)	■ (4)	■ (4)	■ (4)		
	5000 (*)	■ (4)	■ (4)	■ (4)	■ (4)	■ (4)	■ (4)	■ (4)	■ (4)		
Dimensions	mm	H	2130		2330 (***)		2200		2330 (***)		2330
		D	1405		1605	1590	1405		1605	1590	1605/1805
Approximate mass	kg	820		Max. 850		730		Max. 850		750	

(\*\*\*) With LV cabinet 2330 mm, fan 2800 mm, and gas duct 3100 mm.

(1) Width: 650 mm. (2) Width: 750 mm. (3) Width: 800 mm. (4) Width: 1000 mm.



# Functions and characteristics

## MT BBE type cubicles

### Metering - Busbar earthing

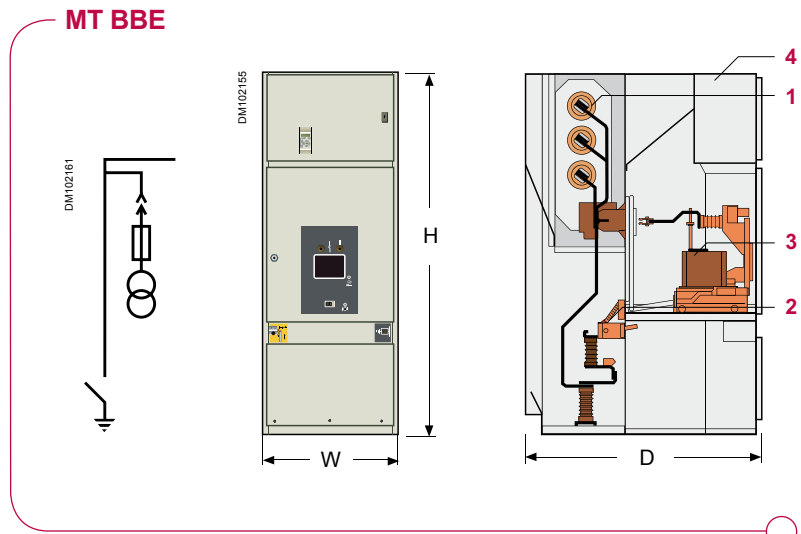

#### MV devices

- 1 Busbars for cubicle interconnection
- 2 Withdrawable Voltage Transformers

#### LV control cabinet

- 3 Low voltage auxiliaries and the protection, monitoring and control unit are in a control cabinet which is separated from the medium voltage part

#### Options

- 2 Earthing switch
- Fixed Voltage Transformers

### Characteristics

		MT BBE 12		MT BBE 17		MT BBE 24	
Rated voltage	kV	12		17.5		24	
Breaking capacity	kA	40	50	40	50	31.5	
Rated current	A						
		630	■	■	■	■	■
		1200	■	■	■	■	■
Dimensions	mm	H	2130	2330 (***)	2200	2330 (***)	2330
		W	650	800	750	800	800
		D	1405/1605	1590	1405/1605	1590	1605/1805
Approximate mass	kg	600	750	650	750	700	

(\*\*\*) With LV cabinet 2330 mm and gas duct 3100 mm.

With today's large and medium-sized industrial installations using MV motors to drive their plants, the controlgear must provide maximum reliability and minimum down time. To meet these specific requirements, PIX MCC supplements our PIX switchgear range.

The PIX Motor Control Center is a slimline design which lines up directly with the PIX range without interface cubicles. The design philosophy and operation are similar to the PIX switchgear range, helping reduce training time and minimize the risk of improper use. The combination of PIX & PIX MCC provides the total solution for power plants, process plants and Oil & Gas applications.

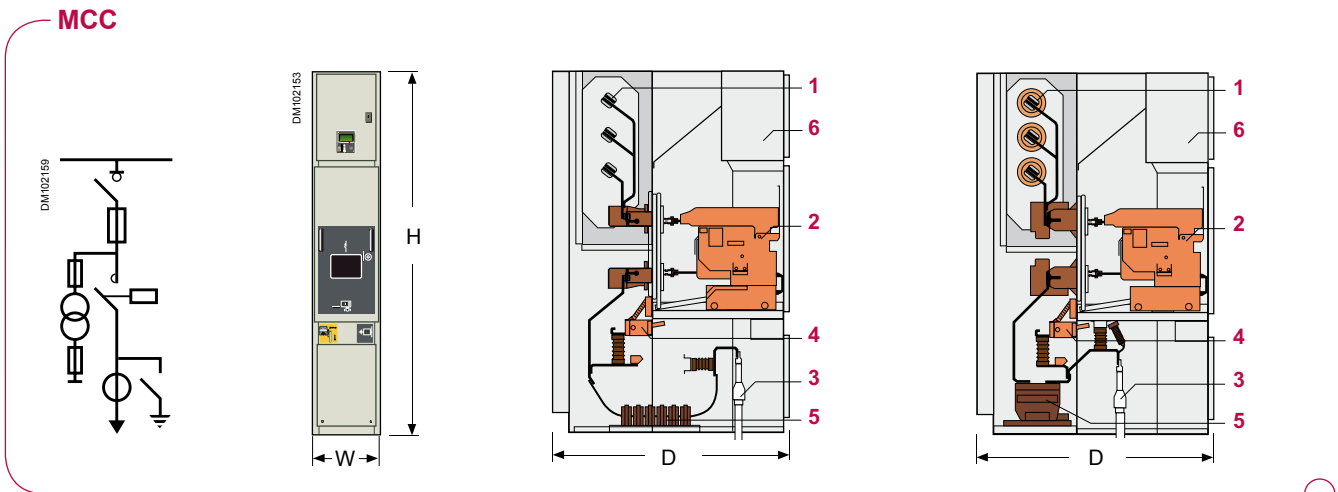

### MV devices

- 1 Busbars for cubicle interconnection
- 2 Withdrawable fused contactor
- 3 MV connections by cables accessible from the front face
- 4 Earthing switch
- 5 Current Transformers

### LV control cabinet

- 6 Low voltage auxiliaries and the protection, monitoring and control unit are in a control cabinet which is separated from the medium voltage part

### Options

- Voltage Transformers
- Rear top/bottom cable entry
- Control voltage transformer (up to 7.2 kV)

### Characteristics

		MCC 7		MCC 12
Rated voltage	kV	7.2		12
Breaking capacity	kA	40	50	40
Rated current	A	195		■
		270	■	■
<b>Current transformer type</b>				
	Din (block)*			■
	Ring**	■	■	
<b>Busbar segregation (Optional)***</b>				■
Dimensions	mm	H	2130	2130
		W	400	400
		D	1405/1605	1590
Approximate mass	kg	700	700	700

(\*) DIN CT's are only available on the 12 kV cubicle (it is a standard PIX cubicle)

(\*\*) Ring type CT's are only available on the PIX MCC 7.2 kV 400 mm wide cubicles

(\*\*\*) Bus bar segregation is only available on 650 mm wide cubicles as an option

DM102187

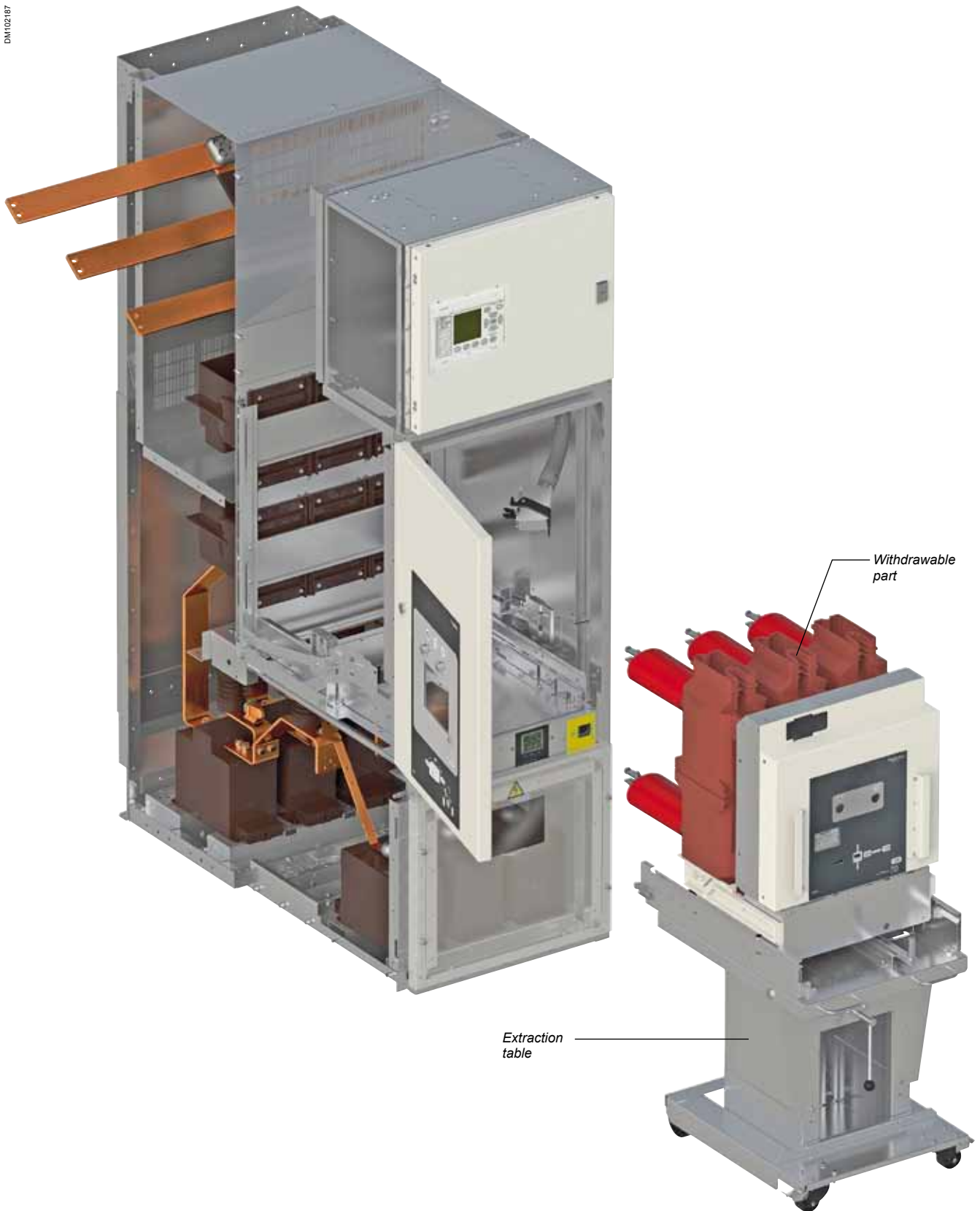

**The devices used to equip the PIX range of functional units have outstanding features:**

- b Long service life
- b Maintenance-free live parts
- b High electrical endurance
- b Operating safety
- b Insensitivity to the environment

**The withdrawable parts:**

- b The circuit breaker, contactor or switch disconnector, the disconnector truck or the earthing truck
  - b The lever-type propulsion mechanism for racking in-out
  - b Interlocks to fix the withdrawable parts onto the fixed part
- The live parts are housed in an insulating enclosure in the sealed pressure system in compliance with IEC 62271-100.

**Circuit breaker**



A circuit breaker is a safety device enabling the switching and protection of electrical distribution networks. Installed in the PIX cubicle, it protects all components situated downstream during a short-circuit.

- Breaking in vacuum
- HVX

**Contactor**

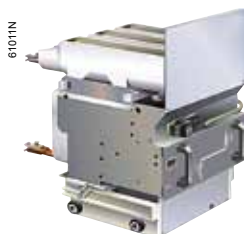

The contactor is a motor control and protection device.

- Breaking in vacuum.
- CVX withdrawable part of the contactor
- CBX contactor

**Switch disconnectors**



The air switch disconnectors have making capacity and are suitable for switching:

- Load currents
- Currents in ring mains
- Transformers, cables and overhead lines
- L-TRI 5

**Earthing truck**

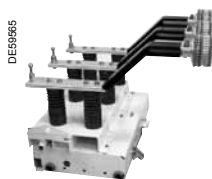

The earthing truck is a safety feature. It enables the injection of voltage for testing either of the earthing of the busbar or of the cables. It is installed instead of the circuit breaker and has the same interlock capabilities.

**Disconnector truck**



The disconnector truck enables the upper and lower part of the cubicle to be short-circuited. It is installed instead of the circuit breaker and has the same interlock capabilities.

**Metering device**



Withdrawable metering unit.  
v MTX

# Switchgear / Apparatus

## HVX circuit breaker

### Presentation - Characteristics

PE93245



HVX up to 2000 A

PE93246



HVX above 2000 A

#### Description of the device

HVX is our latest range of vacuum circuit breakers. It offers a proven state-of-the-art design to meet your specifications for power switching devices in air-insulated switchgear up to 36 kV. HVX brings a valuable solution to your project. Thanks to its improved contact design, our interrupters provide unrivalled performance for their reduced size.

Operating mechanisms have been simplified to increase reliability and give extended life with very low maintenance. Instead of the traditional spring operating mechanism, HVX implemented a shaft system with only one torsion spring, reducing the number of parts and increasing the reliability.

#### Application

HVX is designed to suit all types of applications (utilities, power generation, O&G, industry, etc.) and for breaking short-circuit as well as transformers (under load and no-load conditions), generators, capacitor banks and motors.

#### Flexibility

HVX is available in a range of standard, fixed or withdrawable configurations, with plug-in (finger or tulip type) or bolted connections.

HVX can be integrated in our medium voltage switchboard PIX or can be offered with a pre-engineered power module which incorporates a chassis with metal shutters, earthing switch, mechanical interlocks, multi-functional bushings and various electrical options to facilitate switchboard integration.

#### Standard

HVX has been fully tested according to IEC 62271-100 at 50 Hz and 60 Hz and the latest GOST standards. The highest level of the above mentioned standards has been passed including M2, E2, C2.

HVX has also been certified to ANSI C37.013 for generator circuit breaker applications up to 25 kA.

Electrical characteristics according to IEC 62271-100					
For the cubicles		PIX 12	PIX 17	PIX 24	
Circuit breaker designation		HVX 12	HVX 17	HVX 24	
Rated voltage	kV	12	17.5	24	
Rated current	A rms	Up to 3150	Up to 3150	Up to 2500	
Rated breaking capacity	Short circuit current	kA rms	16/25/31.5/40	25/31.5/40	16/25/31.5
	Cable charging current	A	25	31.5	31.5
	Line charging current	A	10	10	
	Single capacitor bank	A	400	400	
	No load transformer	A	10	10	
Rated making capacity	kA peak	40/63/80/100	63/80/100	40/63/80	
Rated operating time	Opening	ms	40-47	40-47	40-47
	Breaking	ms	55-62	55-62	55-62
	Arcing	ms	2-15	2-15	2-15
	Closing	ms	50-58	50-58	50-58
Rated operating sequence	O-3 min-CO-3 min-CO	■	■	■	
	CO-15 s-CO	■	■	■	
	O-0.3 s-CO-3 min-CO	■	■	■	
	O-0.3 s-CO-15 s-CO	■	■	■	
Endurance	Mechanical (C/O) for switching chamber	30 000	30 000	30 000	
	Mechanical (C/O) for mechanism	10 000	10 000	10 000	
	Electrical (C/O at In up to 3150 A)	10 000	10 000	10 000	

PE60631

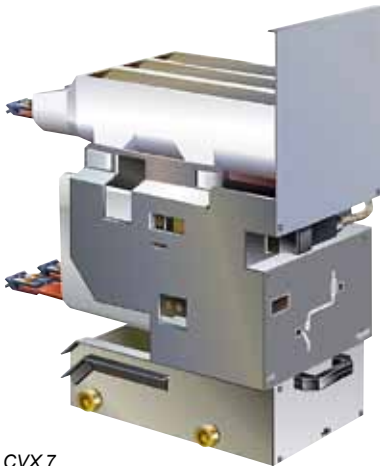

CVX 7

PE60632



CVX 12

#### Withdrawable fuse vacuum contactor CVX for PIX switchgear

##### Description

The CVX fused vacuum contactor has been specifically developed for switching motors, transformers or capacitive loads.

- 3 phase or single phase
- Magnetic holding or mechanical latch
- Electronic auxiliary supply to allow a wide range of control voltages
- High endurance
- Excellent capacitive switching performance

##### Application

- Starting and protection of medium voltage motors
- Single and back-to-back capacitor banks
- Transformer neutral earthing
- Arc furnaces

##### Ratings

Up to 40 kA (50 kA for CVX 7) in conjunction with fuses

##### Standard

IEC, GB (chinese) standards

Electrical characteristics			
For the cubicles		PIX 7	PIX 12
Mobile part designation		CVX 7	CVX 12
Contactor designation		CBX	CBX
Category		AC3 - AC4	AC3 - AC4
Rated voltage	kV	7.2	12
Rated current	A rms	400	400
Maximum motor rated current	A	320	160
Rated breaking capacity	Short circuit current with fuses	kA rms	40/50
	Short circuit current without fuses	A rms	6
	Single capacitor bank	A	280
Rated making capacity with fuses	kA peak	100	100
Rated making capacity without fuses	kA peak	15	10
Rated operating time	Opening with DC magnetic holding control	ms	60 to 100
	Opening with AC magnetic holding control	ms	90 to 120
	Opening with mechanical latch control	ms	20 to 30
	Closing	ms	60 to 100
Rated operating sequence number	Per hour	1200	1200
Endurance	Mechanical with magnetic holding (C/O)		3 000 000
	Electrical with mechanical latch (C/O)		200 000
	Electrical (C/O at 400 A)		500 000
	Electrical (C/O at 250 A)		1 000 000
	Electrical (breaking at Icc 3.2 kA)		25
	Electrical (making at Icc 4 kA)		100



PM103211

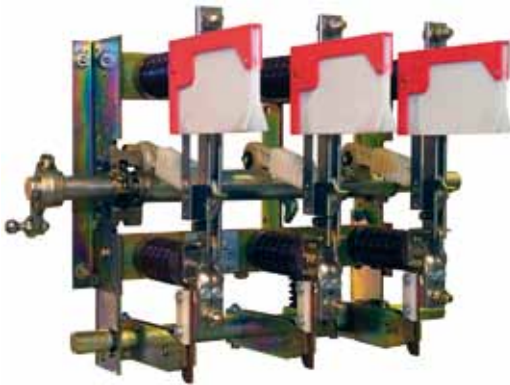

Transformer disconnecter L-TRI 5F

### Description

L-TRI 5 switch disconnecters are designed for use in indoor medium-voltage switchgear systems.

The L-TRI 5 range of switch disconnecters, incorporating proven flat-chamber arcing technology, can perform a wide variety of switching functions in medium-voltage distribution systems.

The simple, low-maintenance and highly economic indoor switch disconnecters in the L-TRI 5 range have a proven service record, with hundreds of thousands of units installed and operating on a wide range of systems.

### Conformity to standards

L-TRI 5 switch disconnecters comply with the requirements of IEC 60694 (EN 60694) and IEC 60265-1 (EN 60265-1).

L-TRI 5F additionally, selected variants are available, complying with IEC 62271-105.

Electrical characteristics		L-TRI 5			L-TRI 5F	
		Fuse switch-disconnector			Switch-disconnector fuse combination	
Rated voltage	kV	12	17.5	24	12	24
Rated current	A	400/630			200 (1)	
Rated short-time current	kA 1 s	25			16	
	kA 3 s	18			-	
Rated peak current	kA	63			40	
Rated short-circuit making current	kA	63			40	
Mechanical operations	n	1500			1500	

(1) In general, the rated current of a switch disconnector fuse combination is lower than the rated current specified by the fuse manufacturer

# Installation

## Accessories and extraction withdrawable parts

**Door locking key**



**Handle switching compartment**



**Earthing switch operating lever**



**Plug in handle**



**Circuit breaker mechanism reset handle**



**L-TRI isolating sheet**

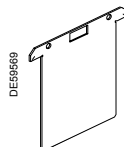

**Handling trolley**



# Installation Implementation example PIX 24 kV line-up switchboard

**Line-up switchboard**  
(2 supply cubicles and 1 bussection at 24 kV)

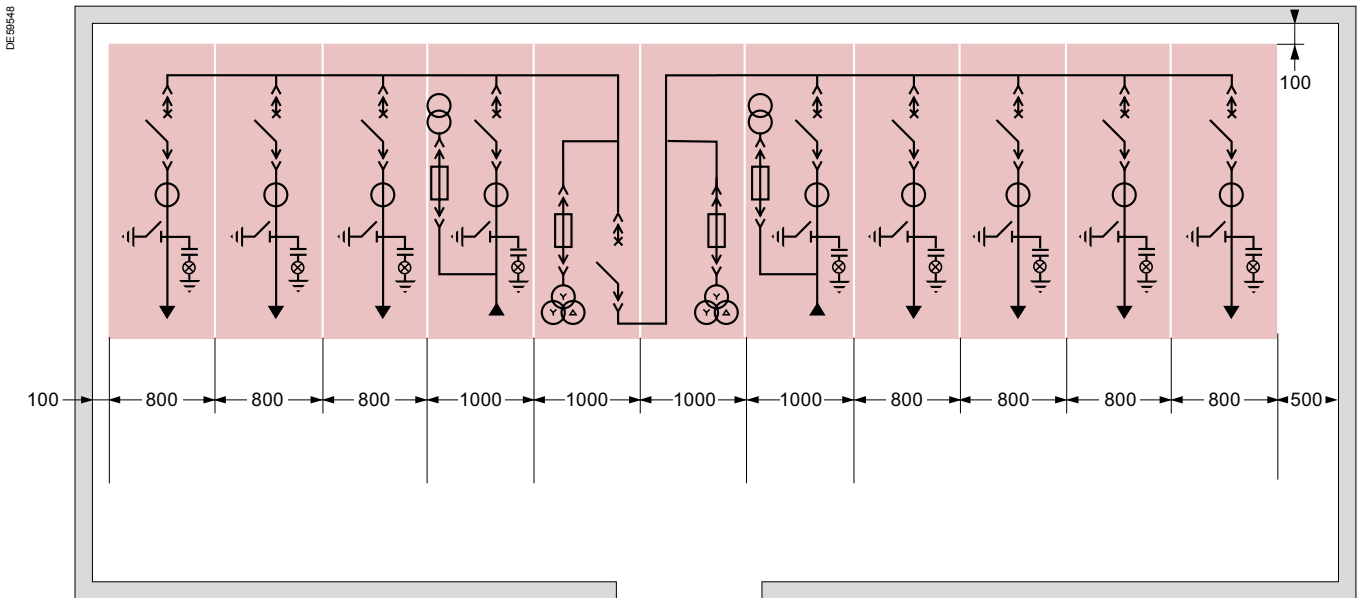

## PIX width 650, 750 and 800 mm

DE96560

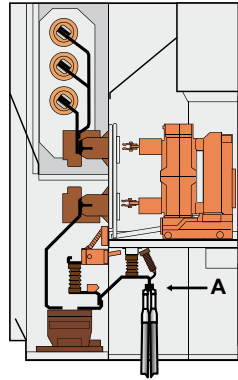
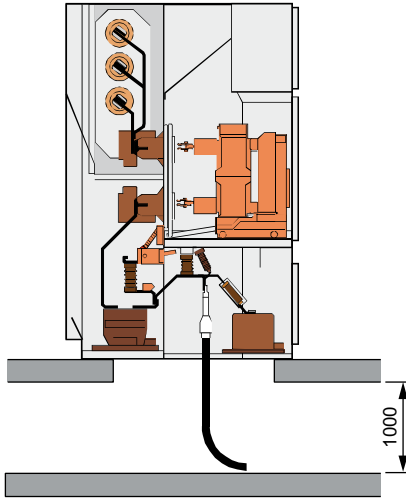

- 1 x cable per phase
- 2 x cable per phase

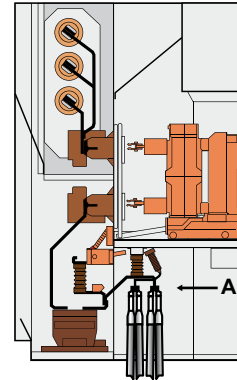

- 3 x cable per phase
- 4 x cable per phase

View-A

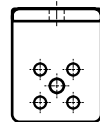

## PIX width 1000 mm

DE96551

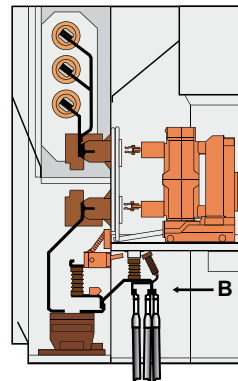
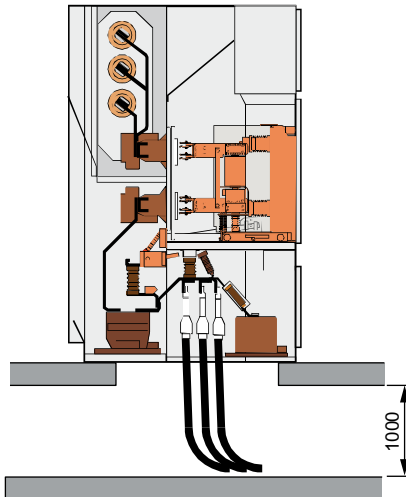

- 2 x cable per phase
- 4 x cable per phase
- 6 x cable per phase

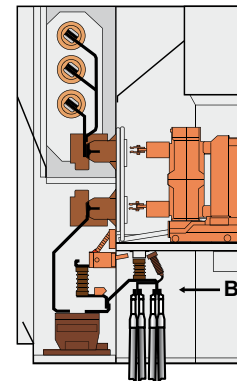

- 8 x cable per phase

View-B

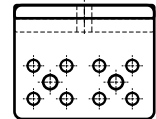

## Standard cable connection: maximum size and number per phase

Functions	12 kV		17.5 kV		24 kV	
	Width (mm)	Cable max. (no. x size) <sup>(1)</sup>	Width (mm)	Cable max. (no. x size)	Width (mm)	Cable max. (no. x size)
CB incoming/outgoing Direct incoming	650	4 x 630	750	4 x 630	800	4 x 630
	800	4 x 630	1000	6 x 630 <sup>(3)</sup>	1000	6 x 630 <sup>(3)</sup>
	1000	8 x 630	–	–	–	–
Switch-disconnector without fuse (LTRI)	650	1 x 630	750	1 x 630	800	1 x 630
Switch-disconnector with fuse (LTRI)	650	1 x 95	750	1 x 95	800	1 x 95
Contactors: CVX 12 <sup>(2)</sup>	650	2 x 240	–	–	–	–

<sup>(1)</sup> Cable size is the cross sectional area in mm<sup>2</sup> based on a single core cable.

<sup>(2)</sup> For PIX 7.2 kV with CVX, see PIX-MCC.

<sup>(3)</sup> 8 cables are subject to customisation.

# Installation Connections

## PIX rear cable box top and bottom entry

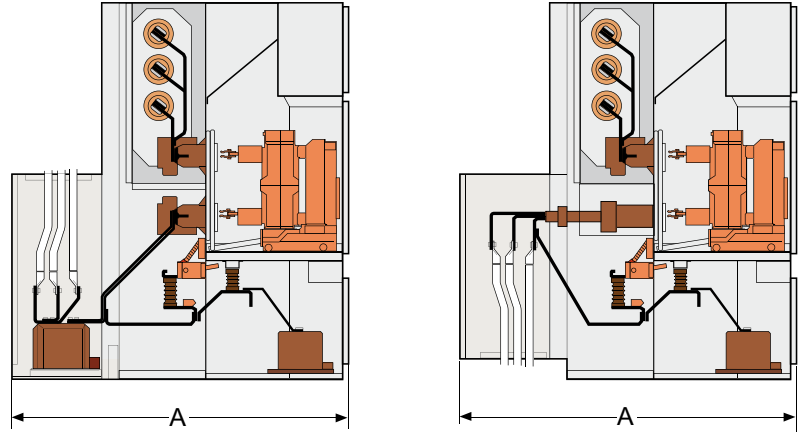

Maximum 6 cables per phase (630 mm<sup>2</sup>).  
Maximum 2 cables per phases (1200 mm<sup>2</sup>).  
Depth A on demand.

## Standard cable connection

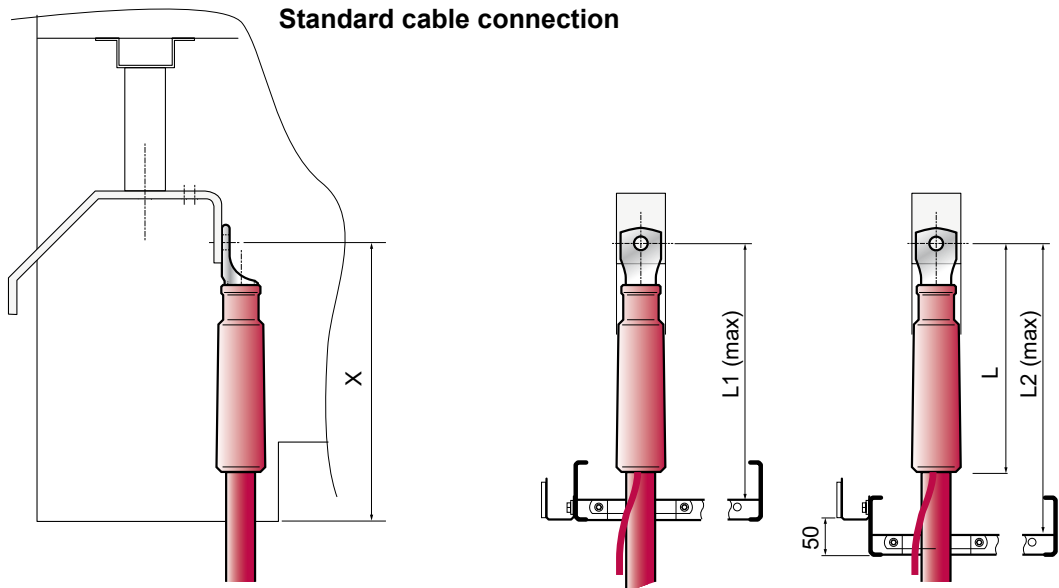

Note: position of the standard cable floor and clamp can be adjusted 50 mm deeper during installation if necessary.

Dimensions (mm)	PIX 12	PIX 17	PIX 24
X	430	460	555
L1	400	430	525
L2	450	480	575

Equipment			Type of cubicle						
			CB	MCC 12	MCC 7	BC CB + RMT	BC CB + RMT	MT BBE	T1
<b>Switchgear</b>									
Circuit-breaker			■				■		
Contactors				■	■				
Fuse switch									■
Disconnecting truck			■	■	■		■		
Earthing truck			□	□	□		□		
Fixed busbars							■	■	
Racking position indication contact for the withdrawable part	4 NO + 4 NC 2 NO + 2 NC		■				■	■	
Padlocking of isolating shutters for withdrawable parts			■	■	■		■		
Locking of withdrawable part/cable compartment			□	□	□		□		
Disabling of circuit-breaker operating mechanism			□				□		
Voltage present indicator			■	■	■		■	■	■
Locking of mechanical racking of the withdrawable part (padlock)			■	■	■		■		
Locking of mechanical racking of the withdrawable part (keylock)			□	□	□		□		
Locking of the electromagnetic racking of the withdrawable part			□	□	□		□		
<b>Earthing switch (SMALT)</b>									
Earthing switch			□	□	□		□	□	□
Earthing switch position indication contacts	4 NO + 4 NC		□ (1)	□ (1)	□ (1)		□ (1)	□ (1)	□ (1)
Earthing switch position key locking			□	□	□		□	□	□
Electromagnetic earthing switch position locking			□	□	□		□	□	
<b>Transformers</b>									
Voltage Transformers (1 per phase)	Without fuse	Phase-phase							
		Phase-earth	□	□		□	□	□	
	With plug-in fuses	Phase-phase							
		Phase-earth	□	□		□	□	□	
Fuse melting indication contact		1 NO							
Current Transformer	Single set	3 CT's	■	■			□	□	
	Double set	6 CT's	□	□					
	LV toroid transformer CT (3)		□						
<b>Connections</b>									
Connection with cable terminal height > 460 mm			■	■	■				■
Connection from top bar			□	□	□				
Connection by cable from the top			□	□	□				
Connection by cable from the bottom			■	■	■				■
<b>Cubicle</b>									
Protection index (6)	Enclosure	IP3X	■	■	■		■	■	■
		IP4X	□	□	□		□	□	□
		IPX1							
		IPX2							
Anti-arcing protection (2)	Compartments (4)	IP2XC	■	■	■		■	■	■
		25 kA - 1 s	□	□	□		□	□	□
		31.5 kA - 1 s	□	□	□		□	□	□
		40 kA - 1 s	□	□	□		□	□	□
		50 kA - 1 s							
Thermal diagnosis system (6)			□	□	□		□	□	
Lightning arrester			□	□	□			□	
<b>Busbars</b>									
1250 A / 2500 A / 3150 A / 4000 A (5)		Exposed	■	■	■		■	■	■
		Insulated	□	□	□		□	□	□
LV control cabinet key locking			□	□	□		□	□	□
LV control cabinet lighting			□	□	□		□	□	□
Anti-condensation heating element			□	□	□		□	□	□

■: basic equipment.

□: option.

(1) Basic equipment with earthing switch option.

(2) According to the room in which the PIX switchboard is installed, you can choose an option for 3 or 4 sides, and possibly an exhaust tunnel for hot gases (see page E-9).

(3) Connection of 1 or 2 cables per phase.

(4) Compartment protection.

(5) For 4000 A equipped with fans.

(6) Consult us.



---

Air Insulated Switchgear up to 24 kV  
Protection, monitoring  
and control



---

## Protection relays

Protection relay selection	E-2
Sepam protection system	E-4
MiCOM protection system	E-6

---

<b>Control relays</b>	<b>E-7</b>
-----------------------	------------

---

<b>Arc fault detectors</b>	<b>E-8</b>
----------------------------	------------

---

<b>Thermal diagnosis</b>	<b>E-10</b>
--------------------------	-------------

---

## Current Transformers

Current Transformers for MCset	E-11
Current Transformers for PIX	E-14

---

## Voltage Transformers



Voltage Transformers for MCset	E-16
Voltage Transformers for PIX	E-17

---

Protection relays						
Sepam series 10	MiCOM Px10	Sepam series 20	Sepam series 40	MiCOM Px20	Sepam series 60	
<b>Functions</b>						
Provides protection of network for each application: Substations (incomer or feeder type) / Transformers / Motors / Generators / Busbars / Capacitors						
Each relay series offers all of the functions required for:						
<ul style="list-style-type: none"> <li>■ Effective protection of life and property</li> <li>■ Accurate measurements and detailed diagnosis</li> <li>■ Integral equipment control</li> <li>■ Local or remote indications and operation</li> </ul>						
<b>Self power / Auxiliary supply</b>						
Auxiliary supply	• Auxiliary supply • Self or Dual supply	Auxiliary supply	Auxiliary supply	Auxiliary supply	Auxiliary supply	
<b>Protection</b>						
Current (1 or 5A)	Current (1 or 5A)	• Current (1 or 5A) • Voltage	• Current (1 or 5A) • Voltage	• Current (1 or 5A) • Voltage	• Current (1 or 5A or LPCT) • Voltage	
<i>Phase &amp; Earth basic</i>	<i>Phase &amp; Earth basic</i>	<i>Phase &amp; Earth basic</i>	- <i>Phase &amp; Earth basic</i> - <i>Directional</i>	- <i>Phase &amp; Earth basic</i> - <i>Directional</i>	- <i>Phase &amp; Earth basic</i> - <i>Directional</i> - <i>Synchro-check</i>	
<b>Display</b>						
Standard UMI	Standard UMI	• Standard UMI • Remote UM	• Standard UMI • Remote UM	Standard UMI	• Standard UMI • Remote UM • Mimic based UMI	
<b>Other characteristics</b>						
				Withdrawable hardware	Removable S/W cartridge	
<b>Input / Output (up to)</b>						
4 / 7	6 / 6	10 / 8	10 / 8	7 / 8	28 / 16	
<b>I/O terminals</b>						
Screw type	Screw type	• Screw type • Ring lug	• Screw type • Ring lug	Ring lug	• Screw type • Ring lug	
<b>Temperature sensor (up to)</b>						
		8	8 to 16	10 (motor)	8 to 16	
<b>Communication protocol</b>						
• Modbus RTU • IEC 60870-5-103	• Modbus RTU • IEC 60870-5-103	• Modbus RTU • IEC 60870-5-103 • DNP3 • Modbus TCP/IP • IEC 61850 No GOOSE	• Modbus RTU • IEC 60870-5-103 • DNP3 • Modbus TCP/IP • IEC 61850 No GOOSE • RSTP*	• Modbus RTU • IEC 60870-5-103 • DNP3	• Modbus RTU • IEC 60870-5-103 • DNP3 • Modbus TCP/IP • IEC 61850 Standard GOOSE • RSTP*	
<b>Logic equations</b>						
			Comprehensive logic equations	Basic logic equations	Comprehensive logic equations	
<b>Safety characteristics</b>						
					IEC 61508-SIL2	
<b>IEC and specific country standards (UL, CSA, GOST...)</b>	<b>IEC and specific country standards (GOST...)</b>	<b>IEC and specific country standards (UL, CSA, GOST...)</b>	<b>IEC and specific country standards (UL, CSA, GOST...)</b>	<b>IEC and specific country standards (GOST...)</b>	<b>IEC and specific country standards (UL, CSA, GOST...)</b>	

\* Ethernet high availability communication



Sepam series 80	MiCOM Px30	MiCOM Px40
		
PE90512	PE90437	PE90436
<b>Functions</b>		
<b>Self power / Auxiliary supply</b>		
Auxiliary supply	Auxiliary supply	Auxiliary supply
<b>Protection</b>		
<ul style="list-style-type: none"> <li>• Current (1 or 5A or LPCT)</li> <li>• Voltage</li> </ul>	<ul style="list-style-type: none"> <li>• Current (1 or 5A)</li> <li>• Voltage</li> </ul>	<ul style="list-style-type: none"> <li>• Current (1 or 5A)</li> <li>• Voltage</li> </ul>
<ul style="list-style-type: none"> <li>- Phase &amp; Earth basic</li> <li>- Directional</li> <li>- Synchro-check</li> <li>- Differential</li> </ul>	<ul style="list-style-type: none"> <li>- Phase &amp; Earth basic</li> <li>- Directional</li> <li>- Synchro-check</li> <li>- Differential</li> <li>- Line differential</li> <li>- Distance</li> </ul>	<ul style="list-style-type: none"> <li>- Phase &amp; Earth basic</li> <li>- Directional</li> <li>- Synchro-check</li> <li>- Differential</li> <li>- Line differential</li> <li>- Distance</li> <li>- Busbar differential</li> </ul>
<b>Display</b>		
<ul style="list-style-type: none"> <li>• Standard UMI</li> <li>• Remote UM</li> <li>• Mimic based UMI</li> </ul>	<ul style="list-style-type: none"> <li>• Standard UMI</li> <li>• Remote UM</li> <li>• Mimic based UMI</li> </ul>	<ul style="list-style-type: none"> <li>• Standard UMI</li> </ul>
<b>Other characteristics</b>		
Removable S/W cartridge		
<b>Input / Output (up to)</b>		
42 / 23	50 / 26	32 / 32
<b>I/O terminals</b>		
<ul style="list-style-type: none"> <li>• Screw type</li> <li>• Ring lug</li> </ul>	<ul style="list-style-type: none"> <li>• Screw type</li> <li>• Ring lug</li> </ul>	Ring lug
<b>Temperature sensor (up to)</b>		
8 to 16	1/9/10	10
<b>Communication protocol</b>		
<ul style="list-style-type: none"> <li>• Modbus RTU</li> <li>• IEC 60870-5-103</li> <li>• DNP3</li> <li>• Modbus TCP/IP</li> <li>• IEC 61850</li> <li>• Customised GOOSE</li> <li>• RSTP*</li> </ul>	<ul style="list-style-type: none"> <li>• Modbus RTU</li> <li>• IEC 60870-5-103</li> <li>• DNP3</li> <li>• IEC 61850 with GOOSE</li> <li>• RSTP / SHP / DHP*</li> </ul>	<ul style="list-style-type: none"> <li>• Modbus RTU</li> <li>• IEC 60870-5-103</li> <li>• DNP3</li> <li>• IEC 61850 with GOOSE</li> <li>• RSTP / SHP / DHP*</li> </ul>
<b>Logic equations</b>		
Control logic by ladder diagram	Comprehensive logic equations	Comprehensive logic equations
<b>Safety characteristics</b>		
IEC 61508 - SIL2		
<b>IEC and specific country standards (UL, CSA, GOST...)</b>	<b>IEC and specific country standards (GOST...)</b>	<b>IEC and specific country standards (GOST...)</b>



**Benefits**

**Sepam**

- Hardware modularity and common hardware modules
- Large range of auxiliary power
- ROHS compliant and conformal coated components

**MiCOM**

- Complete and comprehensive product offer
- Full IEC 61850 solution with goose
- All-in-the-box solution

# Protection relays

## Sepam protection system

FE60000



### Sepam: protection digital relays

**Sepam** is a range of digital monitoring protection and control units. Sepam is at the centre of the protection, monitoring and control system for the MCset functional units: all of the necessary protection, metering, control, monitoring and signalling functions are performed by **Sepam**.

The **Sepam** range is defined to provide an optimal solution for each application, and includes, for example:

- Sepam S, substation incomer and feeder
- Sepam B, bus sectioning
- Sepam T, transformer feeder
- Sepam M, motor feeder
- Sepam G, generator feeder
- Sepam C, capacitor feeder

The **Sepam** range consists of the **Sepam series 20, series 40, series 60 and series 80**, a range of modular protection relays to adapt precisely to your needs.



Each functional unit can be equipped with a comprehensive protection, monitoring and control system consisting of:

- Instrument transformers (\*) to measure the necessary electrical values (phase current, residual current, voltages, etc.)
- Protection relays, providing functions adapted to the part of the network to be protected
- Metering equipment, to inform operators
- Low voltage relaying, i.e. to provide control of the breaking device (contactor and circuit breaker) of the withdrawable part
- Various auxiliaries: secondary circuit test units, etc.

(\*) Please check the sensor to use in the Sepam catalogue.

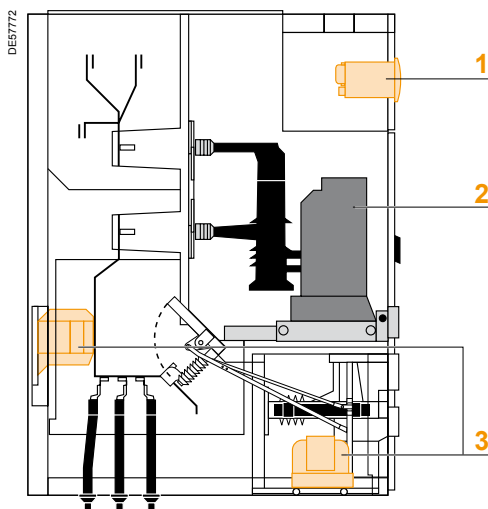

- 1 - Protection relay metering equipment.
- 2 - Switchgear (circuit breaker and contactor).
- 3 - Instrument transformers.

### Protection chain

The Sepam protection units, combined with innovative current sensors, provide a comprehensive measurement, protection and energy management chain\*.

#### A high performance, economical solution

The modular Sepam offer provides a cost effective solution tailored to every requirement.

#### Easy to order and install

All of the components in the protection chain are referenced and can be delivered very quickly.

#### The power of a multi-functional digital unit

Sepam is more than a simple protection relay, it is truly multi-functional unit offering, in particular:

- Circuit breaker diagnosis functions (switching counter and time, rearming time, cumulated broken A2)
- Direct circuit breaker control of whatever type of release unit
- Remote equipment operation using the most standard communication protocols

(\*) Please check in the Sepam catalogue the sensor to use with each Sepam version.

### Sepam advantages

#### Reliability

- Over 30 years of experience in multi-function digital protection relays
- Over 600,000 Sepam units in service in more than 90 countries

#### Quality

- Design quality is based on dependability studies and the strict definition of environmental constraints: temperature, pollution, EMC, dielectric strength, etc.
- All Sepam series 20,40,60 and 80 boards and electronic components are industrially conformally coated. This manufacturing allows Sepam to be used in the most severe industrial environments, including off-shore oil rigs and chemical factories (IEC 60068-2-60 and EIA 364-65A IIIA)
- Quality manufacturing based on procurement agreements with suppliers and inspection throughout all of the manufacturing phases

#### Simplicity of use

- Local operation facilitated by the ergonomic User Machine Interface informing the operator fully and clearly in his own language
- Ease-of-setup thanks to the flexibility and user-friendliness of the parameters setup software



The Sepam range of protection relays is designed for the operation of machines and electrical distribution networks of industrial installations and utility substations at all voltage levels.

It includes 3 families:

- Sepam series 20, for usual applications.
- Sepam series 40, series 60, for demanding applications.
- Sepam series 80, for custom applications.

To cover all needs, from the simplest to the most complete.

Sepam complies with IEC 61850 (series 20, 40, 60, 80).

## Sepam multifunction protection relays

### A range of solutions adapted to your application

- Substation protection (incomers, feeders, busbars)
- Transformer protection
- Motor and generator protection
- 

### All of the necessary functions for your application

- Effective protection of people and property
- Accurate measurements and detailed diagnosis
- Integral equipment control
- Local or remote indication and operation

### Flexibility and upgrading capability

To adapt to as many situations as possible and to allow for future installation upgrades, optional modules may be added to Sepam at any time for new functions.



## Sepam 100 additional units

Sepam 100 units round off the Sepam range and can be installed either separately or combined with Sepam series 20, series 40, series 60 and series 80 units.

### Sepam 100 has several variants:

- Sepam 100 MI has local breaking device control and signalling modules (many different line diagram types are available)
- Sepam 100 LA contains self-powering protection (back-up protection without auxiliary power supply)



Sepam 100 MI



Sepam 100 LA

PE57800

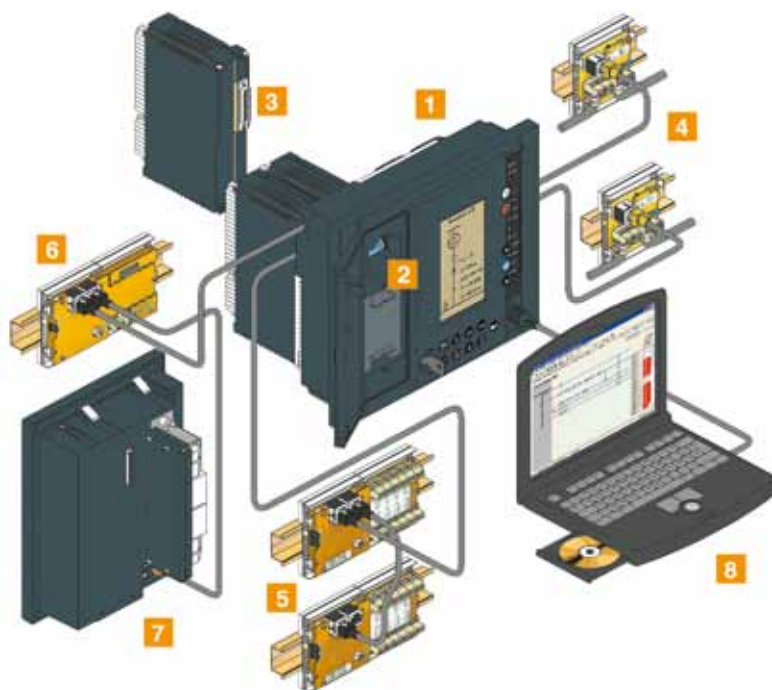

## Sepam series 80 modular architecture

1 - Base unit, with two types of User Machine Interfaces (UMI):

- Integrated mimic-based UMI
- Integrated or remote advanced UMI

2 - Parameters and protection settings saved on a removable memory cartridge

3 - 42 logic inputs and 23 relay outputs, including 5 outputs on the base unit, plus 3 optional modules, each providing 14 inputs and 6 outputs

4 - 2 independent Modbus communication ports:

- Connection of each port to 1 or 2 S-LAN and/or E-LAN networks
- Modbus, Modbus TCP/IP, IEC60870-5-103, DNP3 and IEC 61850 communication protocols
- GOOSE messages and TCP/IP redundancy
- RS485 (2 or 4 wire) or fibre-optic network

5 - Temperature data from 16 sensors: Pt100, Ni100, or Ni120

6 - 1 analogue output: 0-1 mA, 0-10 mA, 4-20 mA or 0-20 mA

7 - Synchro-check module

8 - Software tools:

- Sepam parameter and protection setting and control function customisation
- Programming of specific functions (Logipam)
- Recovery and display of disturbance recording data
- Local or remote operation via a communication network



# Protection relays

## MiCOM protection system

PM1002898



### MiCOM protection relays

MiCOM protection provides the user with a choice of cost-optimised solutions for specific protection requirements within the distribution network.

The MiCOM relay series offers comprehensive protective function solutions for all power supply systems, as well as for the various functional and hardware project stages.

With their modular design, the MiCOM device platforms provide the user with multifunctional equipment that can act as :

- Grid protection equipment, and
- Combined protection and control systems
- MiCOM devices integrate most standard communication protocols used in station control systems and SCADA systems
- Due to the continuous further development of these products, compatibility with technical progress in the field of switchgear and controlgear communication is ensured

### MiCOM offers varying levels of functionality and hardware

- **Series 10** is designed for universal overcurrent protection for the primary or back-up protection on LV or MV systems
- **Series 20** fulfills the basic requirements of industrial, utility and building applications, providing simplicity and ease of use in a wide range of installations
- **Series 30** is designed to meet the rigorous requirements of MV & HV applications with particular focus on feeder and transformer protection and control
- **Series 40** fulfills the protection requirements for a wide market of utility and industrial systems and offers a complete range of protection functions



Front panel version 1



Front panel version 2



Base unit



Extension modules

GemControl is a modular unit for control, monitoring, measurement, processing and data transmission. To know the switchboard status at all times and to act with full knowledge of the facts, GemControl maximises smart switchgear management.

### GemControl advantages

#### Safe operation

Robust standard PLC software (IEC 61131-3). Direct motor control of all devices without intermediate relays.

#### Scalable concept for simple or complex applications

All possibilities are covered, from the stand-alone replacement of conventional electrical push-buttons, position indicators, local/remote key switches and metering instruments in low voltage cabinets to smart interfacing between switchgear panels and substation control systems (SCADA).

#### Incomparable flexibility

In all phases of design, parameter setting, operation and upgrading of the installation. Expandable for future needs.

#### Reliability

Type tested according to IEC 255-6 or EN 60255-6. Transferable back-up memory (GemStick).

GemControl equipped Switchgear ensures the highest availability of your electrical network. By closely monitoring the health and status of actual conditions in real time, GemControl will flag any unusual or detrimental conditions, helping you to plan effectively and efficiently.

The robust, Innovative, intelligent modules are linked together to provide, control, monitoring, measurement and metering of all parameters.

The monitored data can be used locally and individually, or linked into a complete Smart Grid automation solution.



### GemControl

The world's first universal Switchgear Controller for all MV applications, designed for Smart Grid ready applications.

- Optimised Switchgear and network performance.
- Extended life, minimal maintenance required.
- Modular, tailored to any application.
- Complementary to a free choice of protection devices.
- Low Cost of Ownership (reduced CAPEX and OPEX).
- Direct control and switchgear monitoring (no interposing devices).

### Arc fault detectors

Vamp 120	Vamp 121	Vamp 221 (+I/O units)*
 <p>PE90601</p>	 <p>PE90502</p>	 <p>PE58216 PE90503</p> <p>VAM 3L VAM 10L VAM 12L VAM 4C</p>

#### Functions

The arc protection unit detects an arc flash in an installation and trips the feeding breaker.  
 An arc flash protection maximises personnel safety and minimises material damage caused by arc faults

#### System features

<ul style="list-style-type: none"> <li>• Typical operation on light only principle</li> <li>- Input for current criteria for I&gt; and L&gt; operation</li> <li>- Integrated 19 - 256 V AC/DC aux. supply</li> <li>• Optimised for wind power and other small applications</li> <li>• Up to 4 arc or smoke sensors</li> <li>• Selective trip for 2 zones and possibility for generator set emergency trip (separate contact)</li> <li>• Operation time 7 ms (including the output relay)</li> <li>• Non-volatile trip status</li> <li>• NO and NC trip outputs (Zone 1)</li> <li>- Self-supervision</li> <li>- Straightforward installation</li> <li>- Cost efficient solution</li> </ul>	<ul style="list-style-type: none"> <li>• Operation on light only</li> <li>• Up to 10 arc or smoke sensors</li> <li>• Single trip contact</li> <li>• Straightforward installation</li> <li>• Operation time 9 ms (including the output relay)</li> <li>• Cost efficient solution</li> <li>• Self-supervision</li> <li>• Binary input for blocking or resetting the unit (programmable)</li> <li>• Possibility for double arc channel activation trip criteria</li> <li>• BIO light transfer possibility to other Vamp device</li> </ul>	<ul style="list-style-type: none"> <li>• Current and light tripping criteria (possibility of tripping by light only)</li> <li>• Operating time 7 ms or less (electromechanical contact)</li> <li>• Accurate location of arc fault utilising point sensors</li> <li>• Four selective protection zones per central unit</li> <li>• Self-supervision of the entire system</li> <li>• Easy interconnect using VX001 cables</li> <li>• Phase current measuring</li> <li>• Earth fault current measuring</li> <li>• Personal protector option</li> <li>• Panel or rail mount I/O units</li> <li>• Circuit breaker fail protection (CBFP)</li> </ul>
---	--	---

#### Sensors

Point sensor - surface - Arc detection from two compartments simultaneously - Self-monitored - Cable length adjustable from 6 m to 20 m down	Point sensor - surface - Arc detection from two compartments simultaneously - Self-monitored - Cable length adjustable from 6 m to 20 m down	Point sensor - surface - Arc detection from two compartments simultaneously - Self-monitored - Cable length adjustable from 6 m to 20 m down
Point sensor - pipe - Self-monitored - Cable length adjustable from 6 m to 20 m down	Point sensor - pipe - Self-monitored - Cable length adjustable from 6 m to 20 m down	Point sensor - pipe - Self-monitored - Cable length adjustable from 6 m to 20 m down
	Portable sensor - Snap-in connection to I/O unit - Enhanced work safety	Portable sensor - Snap-in connection to I/O unit - Enhanced work safety
		Loop sensor (fibre) - Monitors various compartments - Small bending radius for easy installation
<b>IEC standards</b>	<b>IEC standards</b>	<b>IEC standards</b>

\* I/O units: 4 references available (VAM 3L, VAM 10L/LD, VAM 12L/LD, VAM 4C/CD). The choice is to be made according to the needs concerning the type and number of sensors. Please contact us.



#### Benefits

- Personnel safety.
- Reduces production losses.
- Extended switchgear life cycle.
- Reduced insurance costs.
- Low investment costs and fast installation.
- Reliable operation.

The arc protection unit detects an arc flash in an installation and trips the feeding breaker. An arc flash protection system maximises personnel safety and minimises material damage caused by arc faults.

Arc flash protection maximises personnel safety and minimises material damage to the installation in the most hazardous power system fault situations.

Minimised damage also means a limited need for repair work and enables rapid restoration of the power supply.

### Vamp advantages

#### Personnel Safety

A fast and reliable arc protection unit may save human lives in the event of an arc fault occurring in the switchgear during work in or near an installation.

#### Reduces production losses

The shorter the operating time of the arc flash protection unit, the smaller will be the damage caused by the arc fault and the shorter the possible power outage.

#### Extended switchgear life cycle

A modern arc protection unit increases the life-cycle expectancy of switchgear installations, so that decisions to invest in new switchgear installations can be postponed and money can be saved by re-Vamping existing switchgear systems.

#### Reduced insurance costs

The faster and better the protection system of a power installation, the more generous will be the terms and costs of insurance.

#### Low investment costs and fast installation

A comprehensive arc protection system is characterised by low investment costs and fast installation and commissioning times. One successful operation of the arc flash protection units provides an immediate investment payoff.

#### Reliable operation

Operation is based on the appearance of light or alternatively on the appearance of light and current from an external device. Immune to nuisance trippings due to dual tripping criteria: light and current.



Vamp 221



Input/Output units

## + Schneider Electric AIS switchgears - Internal arc compliancy

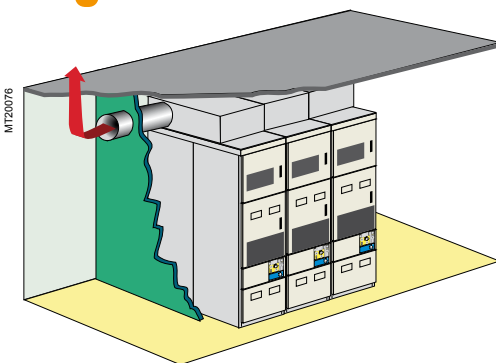

MCset and PIX switchboard with tunnel

### Basic version (gas exhaust)

Our Air Insulated Switchgear is designed to eliminate the effects of small internal arc currents for a short duration, due to:

- Metal flaps positioned on the top of the enclosure which, in the case of an internal fault, limit overpressure in the compartments.
- Nonflammable materials used for the cubicle.

### Internal arc version

Our Air Insulated Switchgear is designed to withstand and protect operators in the case of failure due to an internal arc.

Our Air Insulated Switchgear have been successfully type tested.

Protection against internal arcing is available on devices with 25 kA, 31.5 kA, 40 kA and 50 kA ratings.

Our Air Insulated Switchgear provides several options to install an internal arc switchboard.

#### ■ 3-sided internal arc protection

For a switchboard fitted against a wall, access to the rear of the cubicle is impossible. Internal arc protection on 3 sides is sufficient.

#### ■ 4-sided internal arc protection

In the case of a switchboard installed in the middle of a room, internal arc protection on 4 sides is necessary in order to protect an operator who goes behind the cubicle.

#### ■ Internal arcing detector (option)

Our Air Insulated Switchgear has 2 systems that can detect internal arcing and switch off the power supply to limit the fault duration.

##### □ Electromagnetic detector

This system employs a positive security electromechanical tripping circuit, positioned on the cubicle's flaps (only MCset).

This set transmits the information to the Sepam to give the opening order to the circuit breaker located upstream of the fault.

##### □ Vamp arc flash protection

The arc protection unit detects an arc flash in an installation and trips the feeding breaker. Arc flash protection improves personnel safety and minimises material damage to the installation in the most hazardous power system fault situations.

# Thermal diagnosis for MCset 17.5 kV

Continuity of service is of prime importance for electrical power supplies, particularly for heavy industries.

By using the new thermal diagnosis system developed for MCset, we offer you the possibility of monitoring on an ongoing basis, thus reducing the probability of failure and reducing maintenance time.

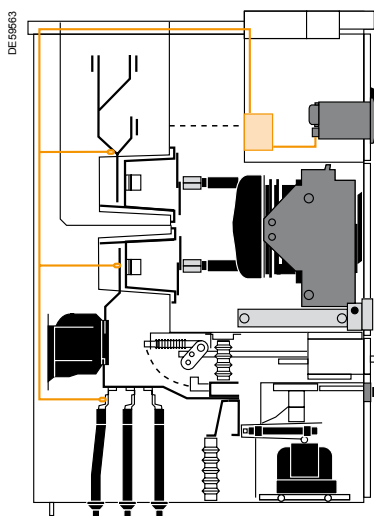

## Use

To reduce maintenance costs in MV substations.

It continuously monitors temperature rise using optical fibres and sensors installed at the heart of the sensitive areas. The sensors are located on sensitive connections (for example, cable connections and on top of MV fuse holders).

## Presentation

Thermal diagnosis is based on the principle of temperature measurement of energised circuits. By using optical fibres, the system does not introduce any risks in terms of insulation.

It provides:

- Permanent monitoring of the temperature rise in power circuits at the connections
- Tripping of a pre-alarm, then an alarm by activating dry contact outputs
- Indication of the zone and circuit involved

The standard solution is composed of the MDT module and two probes as described hereunder.

## Probes CFO733

The optical fibre probes are factory-built assemblies consisting of:

- 3 sensors attached to the power circuit,
- Optical connections, and
- A connector linked to the module

This connector incorporates the opto-electrical conversion unit thus eliminating any optical connections when assembling.

## MDT106 module and MDT107 for Motorpact

The MDT electronic module is mounted in the low voltage compartment of the cubicle. It provides the following functions:

- Monitoring of temperature rise in maximum 3 zones
- Triggering of the pre-alarm
- Triggering of the alarm
- Self-monitoring of the module
- Self monitoring of the temperature probes

## Technical characteristics

### Optical fibre probes CF0733

Maximum equipment voltage	17.5 kV
Rated power frequency voltage	38 kV 1 min - 42 kV 1 min
Impulse voltage	95 kV
Maximum fibre/sensor temperature	120°C

### MDT106 module as example

Temperature rise adjustment	To be defined
Possibility of adjusting the ambient temperature correction	
Maximum absolute threshold value	Pre-alarm = 115°C Alarm = 120°C
Multi9 profile width	10.5 cm
Module power	24/250 Vdc, 110/240 Vac
Dry contact	Voltage 24, 48, 127, 220 Vdc 110 to 240 Vac
	Current 5 A permanent (pre-alarm) 8 A permanent (alarm)
Consumption (standby-max.)	Vdc < 1.2 W (standby) - < 3.4 W (max.) Vac < 4.4 VA (standby) - < 6.6 VA (max.)

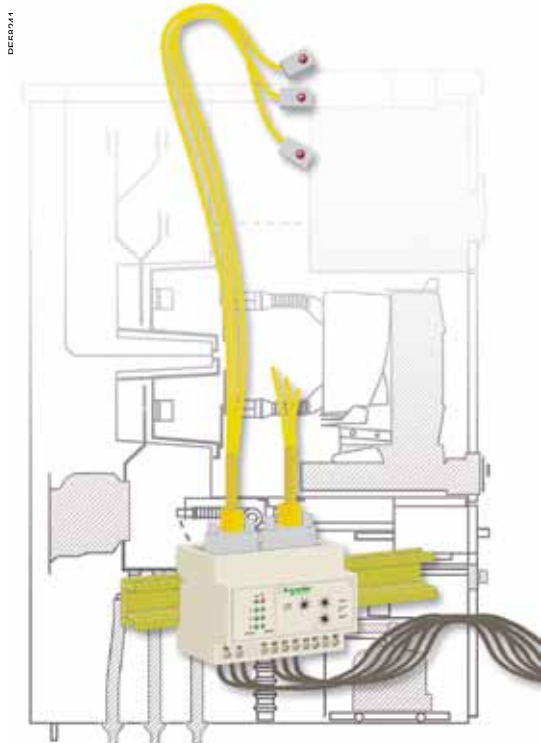

## Conventional Current Transformers

Conventional Current Transformers are used to provide power to metering, measuring or control devices. They measure the value of primary current from 10 A to 3150 A.

Schneider Electric has drawn up a list of Current Transformers which are appropriate for use with digital protection devices in order to make it easier to determine accuracy characteristics.

### For contactor AD1 cubicle

#### Transformer ARJP1/N2J

- Single primary current, double secondary current for measurement or protection
- Frequency 50-60 Hz

I <sub>1n</sub> (A)	10	20	30	50	75	100	150	200	250
I <sub>th</sub> (kA)	1.2	2.4	3.6	6	10	10	10	10	10
t (s)	1	1	1	1	1	1	1	1	1
Measurement* cl.0.5	15 VA								
Protection*	5P20 2.5 VA								

E28876



ARJP1, 2 or 3

### For AD1, CL1, GL1, AD2, CL2, GL2, AD4, RD4, GL4 cubicles

#### Transformer ARJP2/N2J

- Double primary current, double secondary current for measurement or protection
- Frequency 50-60 Hz

I <sub>1n</sub> (A)	50-100	75-150	100-200	150-300	200-400	250-500	600	750
I <sub>th</sub> (kA)	40	40	31.5-40	40	40	40	50	50
t (s)	1	1	1	1	1	1	1	1
Measurement* cl.0.5			5-10VA	10-20 VA	7.5-15VA	10-20 VA	20VA	20VA
Protection*	5P20	2.5-5VA	2.5-5VA	2.5-5VA	5-10VA	5-10VA	7.5VA	7.5VA

### For AD1, CL1, GL1, AD2, CL2, GL2, AD4, RD4, GL4 cubicles

#### Transformer ARJP3/N2J

- Single primary current, double secondary current for measurement or protection
- Frequency 50-60 Hz

I <sub>1n</sub> (A)	1000	1250
I <sub>th</sub> (kA)	50	50
t (s)	1	1
Measurement* cl.0.5	30 VA	30 VA
Protection*	5P20 10 VA	10 VA

### For AD3, CL3, GL3, AD4, RD4, GL4 cubicles

#### Transformer ARJA1/N2J

- Single primary current, double secondary current for measurement or protection
- Frequency 50-60 Hz

I <sub>1n</sub> (A)	1500	2000	2500
I <sub>th</sub> (kA)	50	50	50
t (s)	1	1	1
Measurement* cl.0.5	30 VA	30 VA	30 VA
Protection*	5P20 15 VA	15 VA	15 VA

E74399



ARJA1

### For AD3, CL3, GL3 cubicles

#### Transformer ARO1a/N3

- Single primary current, triple secondary current for measurement or protection
- Frequency 50-60 Hz

I <sub>1n</sub> (A)	3150
I <sub>th</sub> (kA)	50
t (s)	1
Measurement* cl.0.5	30 VA
Protection*	5P20 7.5 VA

E74400



ARO1

\* The secondary current for measuring and protection can be 1 A or 5 A.



# Current Transformers for MCset

E72685

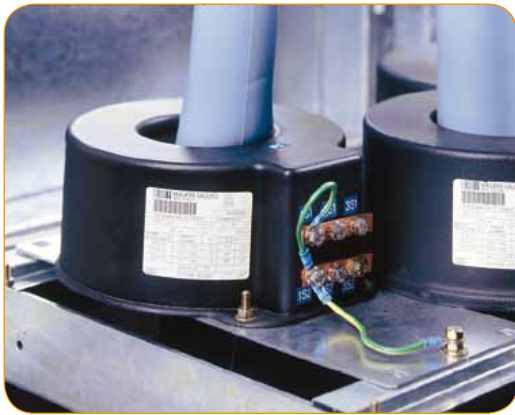

## Low voltage toroid type Current Transformers For AD1, AD2, AD4, RD4 cubicles with one single-pole cable

### Transformer ARC2

- Single primary current, single secondary current for protection
- Frequency 50-60 Hz

I <sub>1n</sub> (A)	75	100	150	200	250	300	400
I <sub>th</sub> (kA)	50	50	50	50	50	50	50
t (s)	1	1	1	1	1	1	1
Protection	5P20	2.5 VA	2.5 VA	5 VA	5 VA	5 VA	5 VA

- Single primary current, double secondary current for measurement or protection
- Frequency 50-60 Hz

I <sub>1n</sub> (A)	200	250	300	400	600
I <sub>th</sub> (kA)	50	50	50	50	50
t (s)	1				
Measurement	5 VA cl.1	10 VA cl.0.5	10 VA cl.0.5	15 VA cl.0.5	15 VA cl.0.5
Protection	5P20	2.5 VA	5 VA	5 VA	5 VA

## For AD1, AD2, AD4, RD4 cubicles with two single-pole cables

### Transformer ARC3

- Single primary current, double secondary current for measurement or protection
- Frequency 50-60 Hz

I <sub>1n</sub> (A)	750	1000	1250
I <sub>th</sub> (kA)	50	50	50
t (s)	1		
Measurement	cl.0.5	20 VA	30 VA
Protection	5P20	7.5 VA	10 VA

E28676



CSH toroid CT

## Zero sequence core balance Current Transformers (CSH type)

CSH 120 and CSH 200 core balance CT's, provide more sensitive protection by the direct measurement of earth fault currents.

Specifically designed for the Sepam range, they can be directly connected to the Sepam "residual current" input.

They are only different in terms of their diameter:

- CSH 120 - 120 mm internal diameter
- CSH 200 - 200 mm internal diameter

PE56604



LPCT in cubicle

### LPCT Low Power Current Transducer

LPCT's are specific current sensors with a direct voltage output of the "Low Power Current Transducer" type, in conformity with standard IEC 60044-8.

LPCT's provide metering and protection functions.

They are defined by:

- The rated primary current
- The extended primary current
- The accuracy limit primary current or the accuracy limit factor

These have a linear response over a large current range and do not start to saturate until beyond the currents to be broken.

#### For cubicle AD4, RD4 with one single-pole cable up to 630 A Transformer TLP160

- Single primary current, double secondary current for measurement or protection
- Frequency 50-60 Hz

I <sub>n</sub> (A)	100 to 2500
I <sub>th</sub> (kA)	40
t (s)	1
Accuracy class	0.5 - 5P

PE56703



TLP 160

PE56397



TLP 190

#### For cubicle AD4, RD4 with two single-pole cables up to 630 A Transformer TLP190

- Single primary current, double secondary current for measurement or protection
- Frequency 50-60 Hz

I <sub>n</sub> (A)	100 to 2500
I <sub>th</sub> (kA)	40
t (s)	1
Accuracy class	0.5 - 5P

#### For AD1, AD1C, AD2, AD3 cubicle

PE56661



PE56663



		CLP1	CLP3
<b>AD1 - AD1C</b>	630/1250 A	■	
<b>AD2</b>	630 A	■	
<b>AD3</b>	1250 A	■	
	2500 A		■

For AD4 please contact us.

Type	Primary current		Secondary voltage (mV)	Accuracy class	Accuracy limit factor FLP	Thermal resistance (kA - 1 s)	Rated insulation			Frequency (Hz)	Secondary connector
	rated (A)	extended (A)					U <sub>r</sub> (kV)	U <sub>d</sub> (kV - 1 min)	U <sub>p</sub> (kV peak)		
<b>CLP1</b>	100	1250	22.5	0.5 - 5P	500	50	17.5	38	95	50/60	RJ45 - 8 pts
<b>CLP3</b>		2500									

# Current Transformers for PIX 12

## Conventional DIN 42600 type Current Transformers

Conventional Current Transformers are used to provide power to metering, measuring or control devices. They measure the value of primary current from 10 A to 2500 A.

Schneider Electric has drawn up a list of Current Transformers which are appropriate for use with digital protection devices in order to make it easier to determine accuracy characteristics.



AD12 or AD14 800 A

### For AD12 or AD14 at 800 A

- Double primary current, double secondary current for measurement or protection
- Frequency 50-60 Hz

I <sub>1n</sub> (A)	50-100	75-150	100-200	150-300	200-400	250-500	600	750
I <sub>th</sub> (kA)	40	40	31.5-40	40	40	40	50	50
t (s)	1	1	1	1	1	1	1	1
Measurement* cl.0.5			5-10 VA	10-20 VA	7.5-15 VA	10-20 VA	20 VA	20 VA
Protection*	5P20	2.5-5 VA	2.5-5 VA	2.5-5 VA	5-10 VA	5-10 VA	7.5 VA	7.5 VA



AD13 1250 A

### For AD13 at 1250 A

- Single primary current, double secondary current for measurement or protection
- Frequency 50-60 Hz

I <sub>1n</sub> (A)	1000	1250
I <sub>th</sub> (kA)	50	50
t (s)	1	1
Measurement* cl.0.5	30 VA	30 VA
Protection*	5P20 10 VA	10 VA



AD15 2500 A

### For AD15 at 2500 A

- Single primary current, double secondary current for measurement or protection
- Frequency 50-60 Hz

I <sub>1n</sub> (A)	1500	2000	2500
I <sub>th</sub> (kA)	50	50	50
t (s)	1	1	1
Measurement* cl.0.5	30 VA	30 VA	30 VA
Protection*	5P20 15 VA	15 VA	15 VA

\* The secondary current for measuring and protection can be 1 A or 5 A.

## Conventional DIN 42600 type Current Transformers

Conventional Current Transformers are used to provide power to metering, measuring or control devices. They measure the value of primary current from 10 A to 2500 A.

Schneider Electric has drawn up a list of Current Transformers which are appropriate for use with digital protection devices in order to make it easier to determine accuracy characteristics.

### For AD21 or AD22 at 800 A

- Double primary current, double secondary current for measurement or protection
- Frequency 50-60 Hz

I <sub>1n</sub> (A)	50-100	75-150	100-200	150-300	200-400	250-500	600	750
I <sub>th</sub> (kA)	40	40	31.5-40	40	40	40	50	50
t (s)	1	1	1	1	1	1	1	1
Measurement* cl.0.5			5-10 VA	10-20 VA	7.5-15 VA	10-20 VA	20 VA	20 VA
Protection*	5P20	2.5-5 VA	2.5-5 VA	2.5-5 VA	5-10 VA	5-10 VA	7.5 VA	7.5 VA

PM103044



AD21 or AD22 800 A

### For AD23 at 1250 A

- Single primary current, double secondary current for measurement or protection
- Frequency 50-60 Hz

I <sub>1n</sub> (A)	1000	1250
I <sub>th</sub> (kA)	50	50
t (s)	1	1
Measurement* cl.0.5	30 VA	30 VA
Protection*	5P20 10 VA	10 VA

PM103045



AD23 1250 A

### For AD23 at 2500 A

- Single primary current, double secondary current for measurement or protection
- Frequency 50-60 Hz

I <sub>1n</sub> (A)	1500	2000	2500
I <sub>th</sub> (kA)	50	50	50
t (s)	1	1	1
Measurement* cl.0.5	30 VA	30 VA	30 VA
Protection*	5P20 15 VA	15 VA	15 VA

PM103045



AD23 2500 A

\* The secondary current for measuring and protection can be 1 A or 5 A.

# Voltage Transformers for MCset

## These supply power to:

- Measuring, metering and monitoring devices
- Relays or protective devices
- Auxiliary LV sources for various types of switchgear; all these devices are protected and insulated from the MV section

They are installed at the bottom of the functional unit. In the withdrawable fuse version, the Voltage Transformers are attached to a side wall. The energised part is entirely encapsulated in an epoxy resin, which provides both electrical insulation and excellent mechanical strength.

## They include the following models:

- With one insulated MV terminal, for connection between neutral and phase conductors in three-phase systems with withdrawable MV fuses
- With two insulated MV terminals, for connection between phase conductors

## For cubicles AD1, CL1, GL1, TT1, AD2, CL2, GL2, AD3, CL3, GL3

### Transformer VRQ3n/S2

- Phase-earth
- Frequency 50-60 Hz



E28679

VRQ3

Primary voltage (kV)	3/√3	3.3/√3	5.5/√3	6/√3	6.6/√3	10/√3	11/√3	13.8/√3	15/√3
1st secondary voltage (V)	100/√3	110/√3	110/√3	100/√3	110/√3	100/√3	110/√3	110/√3	100/√3
2nd secondary voltage (V)	100/√3	110/√3	110/√3	100/√3	110/√3	100/√3	110/√3	110/√3	100/√3
1st secondary accuracy class (VA)	30-50 VA cl.0.5								
2nd secondary accuracy class (VA)	50 VA cl.0.5								

## For cubicles AD2, CL2, GL2, TT2, AD3, CL3, GL3

### Transformer VRC1/S1F

- Phase-phase
- Frequency 50-60 Hz



E28680

VRC1/S1F

Primary voltage (kV)	3.3	5.5	6.6	11	13.8	15
Secondary voltage (V)	110	110	110	110	110	100
Accuracy class (VA)	75 VA cl.0.5					

## For cubicle AD1 contactor

This transformer provides power to the coil in order to keep the magnetic circuit of the contactor closed.

### Transformer VRCR/S1

- Phase-phase
- Frequency 50-60 Hz



MT20104

VRCR

Primary voltage (kV)	3.3	5.5	6.6
Secondary voltage (V)	110	110	110
Accuracy class (VA)	50 VA cl.0.5		

## For AD4, RD4, CL4, GL4, TT4 cubicles

### Transformer VRQ1N/S2

- Phase/earth
- Frequency 50-60 Hz



E74401

VRQ1

Primary voltage (kV)	20/√3	22/√3
1st secondary voltage (V)	100/√3	110/√3
2nd secondary voltage (V)	100/√3	110/√3
1st secondary accuracy class (VA)	50 VA cl.0.5 100 VA cl.1	
2nd secondary accuracy class (VA)	50 VA cl.3P	

**These supply power to:**

- Measuring, metering and monitoring devices
- Relays or protective devices

The energised part is entirely encapsulated in an epoxy resin, which provides both electrical insulation and excellent mechanical strength.

**They include the following models:**

- With one insulated MV terminal, for connection between neutral and phase conductors in three-phase systems
- With two insulated MV terminals, for connection between phase conductors

### Voltage Transformers type phase-earth

**Transformer VDF11 or VDF12**

- Phase-earth
- Frequency 50-60 Hz

PM103042



VDF11 or VDF12

Primary voltage (kV)	3/√3	3.3/√3	5.5/√3	6/√3	6.6/√3	10/√3	11/√3
1st secondary voltage (V)	100/√3	110/√3	110/√3	100/√3	110/√3	100/√3	110/√3
2nd secondary voltage (V)	100/3	110/3	110/3	100/3	110/3	100/3	110/3
1st secondary accuracy class (VA)	30-50 VA cl.0.5						
2nd secondary accuracy class (VA)	50 VA 3P						

### Voltage Transformers type phase-phase

**Transformer VDC12**

- b Phase-phase
- b Frequency 50-60 Hz

PM103043



VDC12

Primary voltage (kV)	3.3	5.5	6.6	11
Secondary voltage (V)	110	110	110	110
Accuracy class (VA)	50 VA cl.0.5			



# Voltage Transformers for PIX 17 and PIX 24

**These supply power to:**

- Measuring, metering and monitoring devices
- Relays or protective devices

The energised part is entirely encapsulated in an epoxy resin, which provides both electrical insulation and excellent mechanical strength.

**They include the following models:**

- With one insulated MV terminal, for connection between neutral and phase conductors in three-phase systems
- With two insulated MV terminals, for connection between phase conductors

## Voltage Transformers type phase-earth

**Transformer VDF21**

- Phase-earth
- Frequency 50-60 Hz



Primary voltage (kV)	3/√3	3.3/√3	5.5/√3	6/√3	6.6/√3	10/√3	11/√3
1st secondary voltage (V)	100/√3	110/√3	110/√3	100/√3	110/√3	100/√3	110/√3
2nd secondary voltage (V)	100/3	110/3	110/3	100/3	110/3	100/3	110/3
1st secondary accuracy class (VA)	30-50 VA cl.0.5						
2nd secondary accuracy class (VA)	50 VA 3P						



## Voltage Transformers type phase-phase

**Transformer VDC21**

- Phase-phase
- Frequency 50-60 Hz

Primary voltage (kV)	3.3	5.5	6.6	11
Secondary voltage (V)	110	110	110	110
Accuracy class (VA)	50 VA cl.0.5			



---

## Services

ProDiag Breaker	F-2
ProDiag Corona	F-3

# ProDiag Breaker

## Diagnosis of MV and LV Circuit Breakers



### What is ProDiag Breaker?

ProDiag Breaker is a Schneider Electric diagnosis tool. ProDiag Breaker compares the mechanical and electrical parameters measured during the full operation of circuit breakers with the data collected from our production facilities. This allows detecting possible failure in advance. It measures, records and displays on a screen the key electrical parameters in MV and LV circuit breakers, relating to opening, closing and springloading operations. All this data is automatically compared with the criteria for the circuit breaker designated in the software, which indicates which values are within the acceptable range, which are on the limit and which are outside it. Two tests are always performed on each circuit breakers, one at minimum voltage and one at nominal voltage. A written report is generated and provided by Schneider Electric so that the customer can use it as a tool to define the necessary corrective action (maintenance, repair or replacement).

### ProDiag Breaker is part of ProDiag preventive maintenance plan

Evaluation of circuit breakers using ProDiag Breaker includes:

- Evaluation of the operating mechanism.
- Measurement and comparison of the actual contact resistance with that specified by the manufacturer.
- Measurement and comparison of the insulation resistance.
- Evaluation of the general circuit breaker conditions based on the captured data.

Moreover, analysis of the ProDiag Breaker time/ travel curve combined with the current curve of the coil and phase contact detects possible faults, such as:

- Worn out latches and operating mechanisms.
- Faulty coils.
- Mechanical wear and tear and hardening of lubricating grease.
- Defective shock absorbers.
- Defective simultaneous contact operation (opening/closing).

Some maintenance programmes involve dismantling the circuit breaker mechanism to check its condition. ProDiag Breaker using signals captured from the circuit breaker operation, reduces maintenance costs compared with programs which check the circuit breakers manually.

### Where can ProDiag Breaker reduce costs?

- ProDiag Breaker significantly reduces the time taken to identify potential faults in a circuit breaker, using operational analysis rather than inspection and mechanical re-sets.
- The software analyses the captured data and identifies the specific problem area.
- A device's normal operating life is increased by timely diagnostics of when and what repairs are necessary.
- The tool comprises both hardware and software, resulting in a highly efficient predictive maintenance program.

### Results

ProDiag Breaker provides a report of the complete nature of the circuit breaker, detailing: closing / opening time, contact simultaneity, bounce and resistance, mechanical closing and opening forces.

This report enables any required maintenance to be targeted and time in order to optimize the customer's maintenance plan.

### ProDiag Breaker Objectives

Your priority is to enhance the reliability of your installation:

- to ensure its continuity of service,
- to minimize the time for maintenance & repair
- to perform maintenance

Only on the equipment requiring it and only when necessary (conditional preventive maintenance)





### What is ProDiag Corona?

**ProDiag Corona** is a Schneider Electric diagnosis tool.

**ProDiag Corona** detects partial discharges in Medium Voltage cubicles.

- Partial Discharge occurs across part of the insulation between two conducting electrodes, without completely bridging the gap.
- Partial discharge can happen under normal working conditions as a result of insulation breakdown due to premature aging caused by thermal or electrical over-stressing of the high voltage system.

ProDiag Corona analyses the primary electrical signal through VIS (Voltage Indicator System) fixed on the switchboards. Measurements are taken by an electronic sensor and the data is transmitted to the ProDiag Corona software in order to evaluate the level of criticality of the controlled equipment.

A written report is generated, which will be handed over by Schneider Electric so that the customer can use it as a tool to define the necessary corrective action, whether maintenance, repair or replacement.

**ProDiag Corona** is not a certification tool.

**ProDiag Corona** executes the assessment of the energized equipment, without any shutdown and then without disruption for the users.

This system allows you to control all types of the most common partial discharges:

- Internal partial discharges
- Surface partial discharge
- Corona effect

**ProDiag Corona** diagnostic can be realized on most Medium Voltage equipment on the market equipped with VIS.

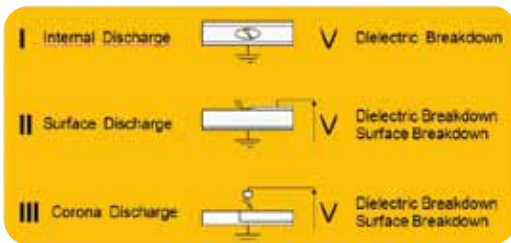

### Where can ProDiag Corona reduce costs?

**ProDiag Corona** significantly reduces the time taken to identify potential faults in a switch, without electrical shutdown.

A device's normal operating life is increased by timely diagnostics of when and what repairs are necessary. **ProDiag Corona** is a trouble shooting anticipation tool which can avoid internal arc risks and untimely tripping.

- The tool comprises both hardware and software, resulting in a highly efficient preventive maintenance program.

### Results

**ProDiag Corona** provides a report of the complete electrical room, detailing : ventilation, air filtration, due point calculation, level of criticability of each set of equipment, constructor recommendations on any potential maintenance, repair & rehabilitation.

This report enables any required maintenance to be targeted and timed to optimize the customer's maintenance plan.

**ProDiag Corona** is performed thanks to XDP2 testing equipment from NDB technology

#### ProDiag Corona objectives

Your priority is to have fast Electrical equipment inspection without shutdown

#### Safety (Human Life and asset)

- Enhance the reliability of your installation
- Optimisation of installation life duration & costs

#### Risks prevention from:

- Partial discharges and internal arc
- Dielectric degradation
- Electrical Fire

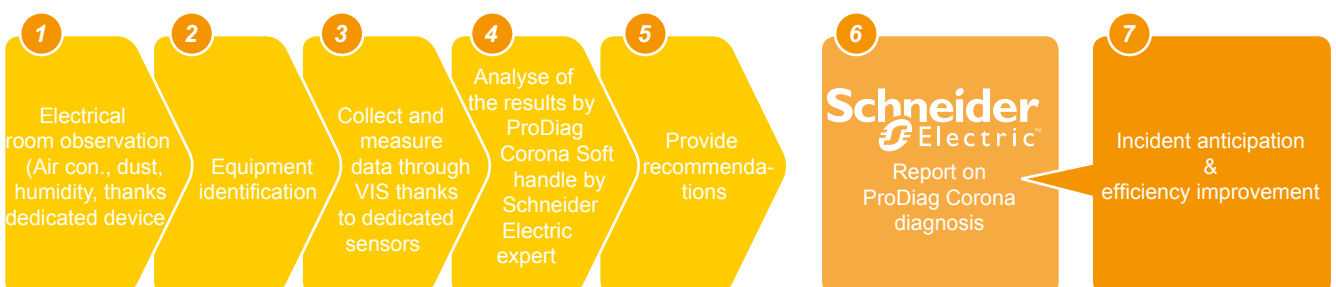

Notes

---





**Contact us:**  
[www.schneider-electric.com/MV-distribution](http://www.schneider-electric.com/MV-distribution)

---

**Schneider Electric**

35, rue Joseph Monier  
CS30323  
F - 92505 Rueil-Malmaison cedex (France)

RCS Nanterre 954 503 439  
Share capital: €928,298,512  
[www.schneider-electric.com](http://www.schneider-electric.com)

NRJED312404EN

As the standards, specifications and designs change from time to time, please ask for confirmation of the information given in this publication.



*This document has been printed  
on ecological paper*

Conception: SYNTHÈSE ECA, Schneider Electric  
Photos: Schneider Electric Industries SAS  
Printing: Altavia St-Etienne - Made in France