

SM6 modular units

Catalog 2020

Air insulated switchgear
Up to 36 kV



General contents

SM6

PV108603

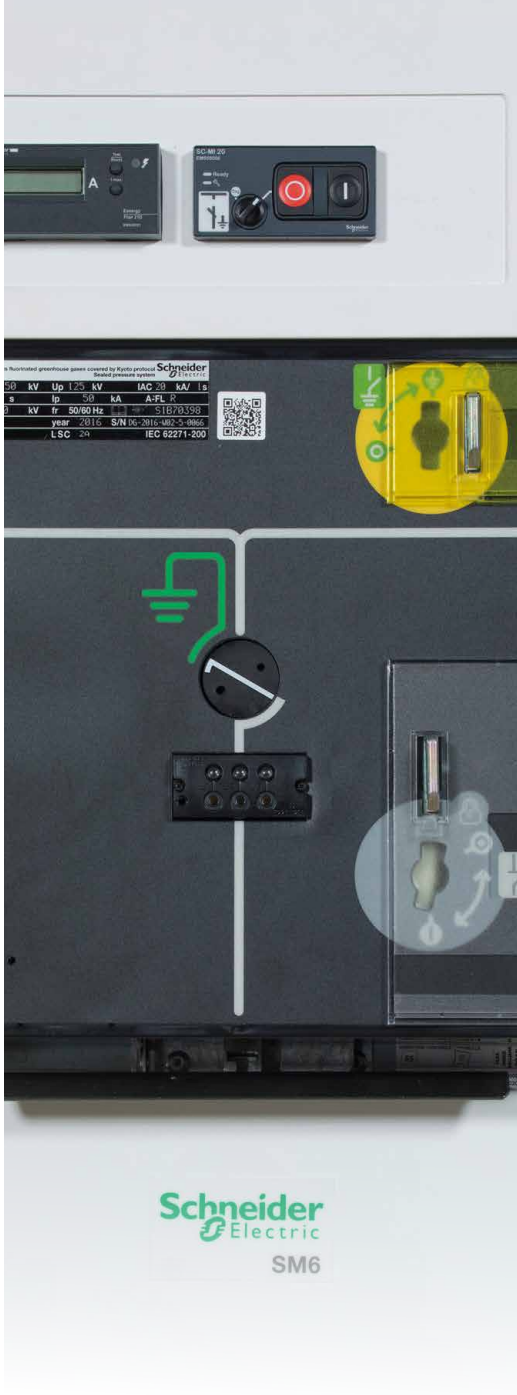

General presentation	10
General characteristics	28
Characteristics of the functional units	54
Protection, control and monitoring	88
Connections	116
Installation	130
Schneider Electric services	144
Appendices - Order form	150

Your concerns

Safety



Reliability



Flexibility



Connectivity



Our solutions

- Enclosures able to withstand internal arcing
3 or 4 sides internal arc protection IAC: A-FL and A-FLR.
Internal arc withstand: 12.5 kA 1s, 16 kA 1s and 20 kA 1s
 - Mechanical and electrical interlocks, to help to prevent incorrect operations
-

- 1 700 000 functions installed world-wide
 - 100% factory-tested without the need for further tests on site
-

- Easy upgraded to meet your need and adapted to the extension of your installations
 - Integration in factory-built outdoor substations for which the SM6 is particularly well designed
-

- Intelligent, connectable components like SC110, CL110 and TH110 provide continuous information about the state of your electrical installations, enabling asset management optimization through preventive maintenance.
Thermal sensor TH110 is fitted from factory by default in cable termination for all the relevant cubicles sold in private market.

SM6

More than **1 700 000** cubicles
installed **world-wide**

PM103624



SM6

A truly professional **solution!**

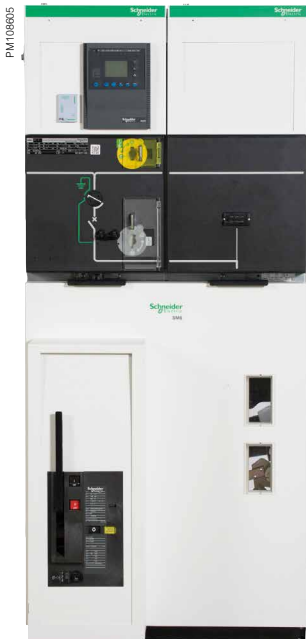

Schneider Electric has developed protection, monitoring and control solutions specifically dedicated to Medium Voltage networks for over 40 years.

SM6 switchgear has been specifically designed on the basis of that extensive experience.

It also incorporates some very new solutions, giving the best in terms of continuity of service and operators' safety.

High-performance breaking devices

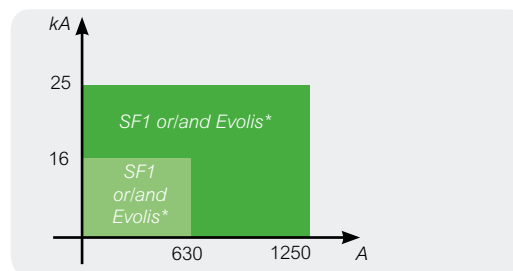

(*) Not available at 36 kV.

A comprehensive solution

SM6 switchgear is fully compatible with

- PowerMeter metering units.
- Easergy P3 relay and Easergy Sepam multi-function protection relays
 - Protection
 - Measurements and diagnosis.
- VIP protection self powered relay for protection. SM6 switchboards can thus be easily integrated into any monitoring and control system.
 - Local & remote indication and operation.



Enclosures able to withstand internal arcing

Internal Arc Classification: A-FL and A-FLR.

- 3-sides internal arc protection IAC: A-FL, 12.5 kA 1s, 16 kA 1s and 20 kA 1s for SM6-24 and 16 kA 1s for SM6-36.
- 4-sides internal arc protection IAC: A-FLR, 12.5 kA 1s, 16 kA 1s and 20 kA 1s for SM6-24.
- Choice of exhaust:
 - downwards exhaust
 - upwards exhaust for SM6-24.

BIM models

A unique opportunity to improve the key driver of the Building market
Still Interoperability is a challenge

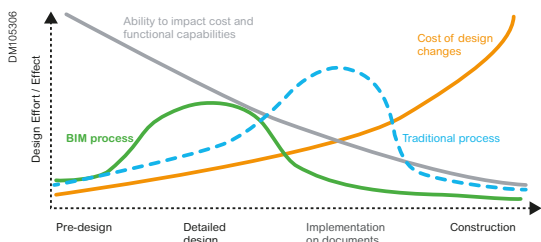

What is BIM

- BIM is an evolution of the Computer Aided Design (CAD) and modeling software market and key to digitization
- It improves on traditional CAD drawings by not only including geometry, but also information that helps in technical and budget calculations
- BIM also refers broadly to the collaborative processes between and or within companies to leverage the value of the models throughout the building design & lifecycle
- Helps create, construct, manage and operate projects more economically and with less environmental impact

Customer requirements



- High value business



- Reduce time and effort required for work.
- Pain: disconnected tools and incapability to share and interact with each other



- Project management across multiple design environment, colleagues and stakeholders is inefficient and not productive.
- Pain: no collaborative platform to support seamless experience for electrical industry to perform electrical tasks and share across companies and geographies.

Benefits of BIM

- Save time on designs
- Decrease project costs
- Improves co-ordination and collaboration
- Minimizes risk
- Helps to easily maintain building lifecycle

BIM and the Building Lifecycle

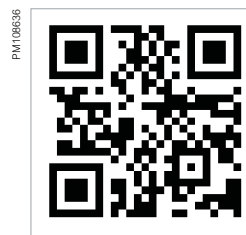
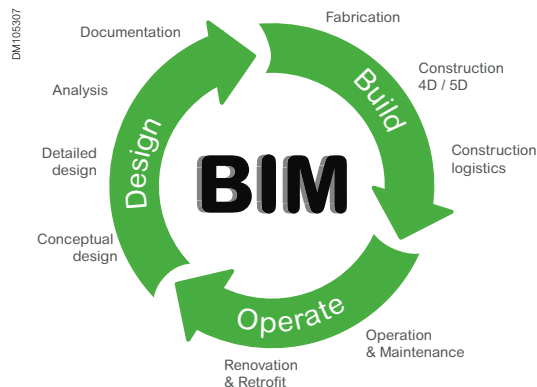

SM6 24 & SM6 36 BIM repositories

- **BIM Object SM6 24 :**
<http://bimobject.com/fr/schneider/product/sm6-24>
- **BIM Object SM6 36 :**
<https://bimobject.com/en/schneider/product/sm6-36>



SM6 3D drawings

- **Objective :**
3D drawings are useful for the our partners (contractor & panel builders) for simulating the installation conditions (fixation points, connection points etc) in a 3D environment.
- **Customer values:**
Reduction of design time. Reduce chances of mistake at installation site.

TracePartOnline application



TracePartsOnline is an accessible component library that includes free 2D CAD drawings & 3D models from Schneider Electric's SM6 offering.

The components are available in different standard formats (ISO, DIN, ANSI, etc.) and also in all formats compatible with native CAD software including PTC Creo Parametric, SolidWorks, CATIA, Pro / Engineer, Inventor, Solid Edge, TopSolid, thinkdesign, Unigraphics, Alibre Design, ACIS, STEP, IGES, DWG, DXF, ...

This platform allows engineers and designers to download and use the CAD files of this offer directly.

SM6 Traceparts repositories

The screenshot displays the TracePartOnline web application interface. At the top left is the 'traceparts' logo with the tagline 'Product Content Everywhere'. A navigation menu includes Home, Catalogs, News, Engineering Community, Vote for 3D, Publish your products, About us, and My account. A search bar and a category dropdown are present. The main content area shows a breadcrumb trail: 'Schneider Electric - Electrical Distribution > Medium Voltage Distribution and Grid Automation > Medium Voltage Switchgear > Secondary Air Insulated Switchgear > SM6-24 > DM1A'. The product title is 'DM1A Single-isolation, disconnectable circuit breaker unit SM6-24: 750 mm'. Below the title is a 3D model viewer showing a vertical circuit breaker unit. A table below the model lists 'Part Number' (SM6240630PR0003) and 'Description' (Single-isolation, disconnectable circuit breaker unit SM6-24: 750 mm). A 'Bill of Materials Data' section follows, listing 'Manufacturer' (Schneider Electric), 'Description' (Single-isolation, disconnectable circuit breaker unit SM6-24: 750 mm), and 'Part Number' (SM6240630PR0003). At the bottom, a section titled 'Users Who Downloaded This Product Also Downloaded' features six product thumbnails: Powerlogic PM5300, Powerlogic PM5100, passthrough terminal block - 4mm²2A, Contactors for motor control, 6 in 16 A in catenov..., Thermal overload relay for motor - TeSvs D - 0.4...32A, and Ac Mi.

General presentation

General presentation

The experience of a world leader	12
The references of a leader	13
The range's advantages	14
EcoStructure™ ready solutions	15
Protecting the environment	24
Quality assurance	25
Schneider Electric services	26
QRcode for SM6 functions	27

The experience of a world leader

The Schneider Electric experience's extends over forty years in factory-built cubicles and over thirty years in SF6 breaking technology for Medium Voltage switchgear.

This experience means that today Schneider Electric can propose a complementary range: vacuum type circuit breaker cubicles up to 24 kV and standard or enhanced internal arc withstand cubicles to reinforce the safety of people according to the IEC standard.

This gives you the advantage of unique experience, that of a world leader, with over 2,500 000 SF6 Medium Voltage units installed throughout the world.

Putting this experience at your service and remaining attentive to your requirements is the spirit of active partnership that we want to develop in offering you the SM6.

The modular SM6 is a range of harmonised cubicles equipped with SF6 or vacuum breaking technology switchgear with 30 years life span.

These cubicles allow you to produce all your Medium Voltage substation requirements up to 36 kV by superposing their various functions.

The result of in-depth analysis of your requirements, both now and in the future, SM6 cubicles mean that you can take advantage of all the features of both a modern and proven technology.

PM1106602



1975 - Innovation:

Sulphur hexafluoride (SF6) is first used in an MV switch for an MV/LV transformer substation, with the VM6.

1989 - Experience:

Over 300,000 VM6 cubicles equipped networks throughout the world.

1991 - Innovation and Experience:

Cumulated with the second generation of SM6 modular SF6 cubicles.

2015 - A leading position:

With over 1,500 000 SM6 cubicles installed around the world, Schneider Electric consolidates its position as uncontested leader in the Medium Voltage field.

2020:

Thermal sensor TH110 is fitted from factory by default in cable termination for all the relevant cubicles sold in private market.

The references of a leader

SM6, a world-wide product



Asia/Middle East

- Canal Electrical Distribution Company - Egypt
- General Motors Holden - Australia
- Pasteur Institute - Cambodia
- Tian he City - China
- Sanya Airport - China
- Bank of China, Beijing, Jv Yanta - China
- Plaza Hotel - Jakarta, Indonesia
- Bali Airport - Indonesia
- Wakasa Control Center - Japan
- Otaru Shopping center - Japan
- New City of Muang, Thong Than, Kanjanapas - Thailand
- Danang and Quinhon Airport, Vanad - Vietnam
- British Embassy - Oman
- KBF Palace Riyadh - Saudi Arabia
- Raka Stadium - Saudi Arabia
- Bilkent University - Turkey
- TADCO, BABOIL development - United Arab Emirates
- Melbourne Tunnel City Link - Australia
- Campus KSU Qassim Riyad - Saudi Arabia

Africa

- ONAFEX, Hilton Hotel - Algeria
- Yaounde University - Cameroon
- Karoua Airport - Cameroon
- Libreville Airport - Gabon
- Ivarto Hospital, CORIF - Madagascar
- Central Bank of Abuja, ADEFEMI - Nigeria
- OCI Dakar, Oger international, CGE - Senegal
- Bamburi cement Ltd - Kenya
- Ivory Electricity Company - Ivory Coast
- Exxon, New Headquarters - Angola

South America/Pacific

- Lamentin Airport, CCIM - Martinique
- Space Centre, Kourou - Guyana
- Mexico City Underground System - Mexico
- Santiago Underground System - Chile
- Cohiba Hotel, Havana - Cuba
- Iberostar Hotel, Bavaro - Dominican Republic
- Aluminio Argentino Saic SA - Argentina
- Michelin Campo Grande - Rio de Janeiro, Brazil
- TIM Data Center - São Paulo, Brazil
- Light Rio de Janeiro - Brazil
- Hospital Oswaldo Cruz - São Paulo, Brazil

Europe

- Stade de France - Paris, France
- EDF - France
- Eurotunnel - France
- Nestlé company headquarters - France
- TLM Terminal , Folkestone - Great Britain
- Zaventem Airport - Belgium
- Krediebank Computer Centre - Belgium
- Bucarest Pumping station - Romania
- Prague Airport - Czech Republic
- Philipp Morris St Petersburg - Russia
- Kremlin Moscow - Russia
- Madrid airport - Spain
- Dacia Renault - Romania
- Lafarge cement Cirkovic - Czech Republic
- Caterpillar St Petersburg - Russia
- Ikea Kazan - Russia
- Barajas airport - Spain
- Coca-cola Zurich - Switzerland

Ease and safe to operate

SM6, a proven range

- A three position switch to block incorrect switching
- The earthing disconnecter has full closing capacity
- Positive breaking of position indicators
- Internal arc withstand in the cable and connection compartments
- Clear and animated display diagrams
- Switching lever with an "anti-reflex" function
- Compartmented cubicles



A range designed with control and monitoring in mind

SM6 switchgear is perfectly adapted to control and monitoring applications.

Motorised, either when installed or at a later date on-site without any interruption in service, SM6 combines with the Easergy T200 remote control interface. You therefore benefit from a ready-to connect unit that is easy to incorporate providing guaranteed switchgear operation.



Compactness

SM6, an optimized range

- Compact units, with low increment cubicles
- Rationalised space requirement for switchboard installation
- Reduction of civil works costs
- Easy integration in factory-built outdoor substations for which the SM6 is particularly well designed.



Upgradability

SM6, a comprehensive range

- A comprehensive offer covering your present and future requirements
- A design adapted to the extension of your installations
- A catalogue of functions for all your applications
- A product designed to be in compliance with standards constraints
- Options to anticipate the control and monitoring of your installations



Maintenance

SM6, a range with reduced maintenance

- The active parts (breaking and earthing) are integrated in an SF6-filled, "sealed for life" unit
- The control mechanisms, are intended to function with reduced maintenance under normal operating conditions
- Enhanced electrical endurance when breaking



EcoStruxure™ ready solutions

What is EcoStruxure™?

500 000

EcoStruxure™ has been deployed in almost 500 000 sites with the support of some 20 000 developers, 650 000 service providers and partners, and 3 000 utilities, and connects over 2 million assets under management.

EcoStruxure™ ready



Efficient asset management

Greater efficiency with **predictive** maintenance helping to reduce downtime.



24/7 connectivity

Real-time data **everywhere anytime** to make better informed decisions.



Increased protection

Proven design and experience combined with **internal arc designs** to enhance people and equipment protection.

EcoStruxure™ is our open, interoperable, IoT-enabled system architecture and platform. EcoStruxure delivers enhanced value around **safety, reliability, efficiency, sustainability, and connectivity** for our customers. EcoStruxure leverages advancements in IoT, mobility, sensing, cloud, analytics, and cybersecurity to deliver Innovation at Every Level. This includes Connected Products, Edge Control, and Apps, Analytics & Services, which are supported by Customer Lifecycle Software.

Turn data into action

EcoStruxure™ architecture lets customers maximize the value of data.

Specifically, it helps them:

- Translate data into actionable intelligence and better business decisions
- Take informed decisions to secure uptime and operational efficiency thanks to real-time control platforms
- Gain visibility to their electrical distribution by measuring, collecting, aggregating, and communicating data

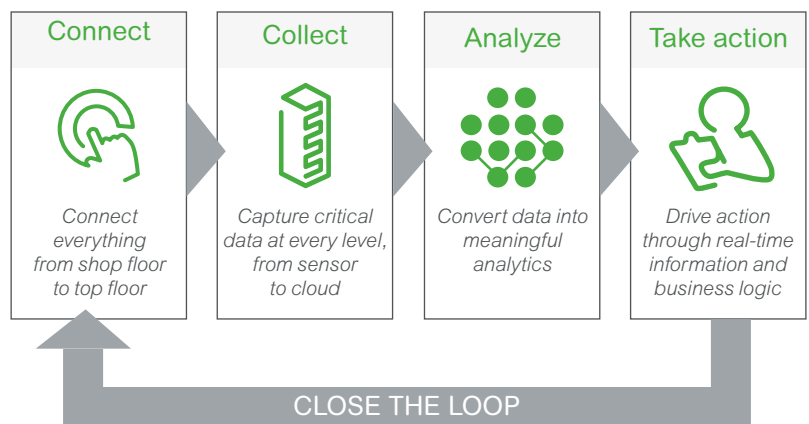

EcoStruxure™ architecture

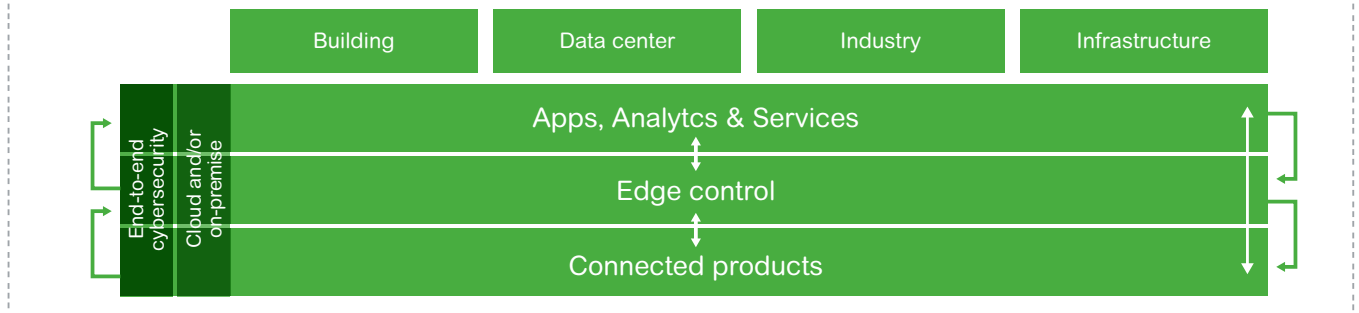

EcoStruxure Power

EcoStruxure Building

EcoStruxure IT

EcoStruxure Machine

EcoStruxure Plant

EcoStruxure Grid

EcoStruxure™ ready solutions

EcoStruxure™ Power

EcoStruxure™ Power is one of the six domains of EcoStruxure™, our IoT-enabled architecture and platform.

EcoStruxure™ Power plays a key role in all four end markets (Building, Data Center, Industry, and Infrastructure). This involves bringing the world of electrical distribution to those end markets.

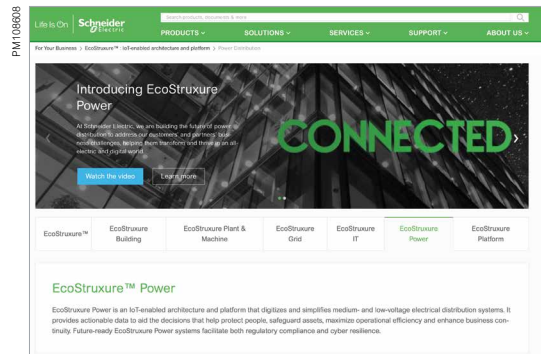
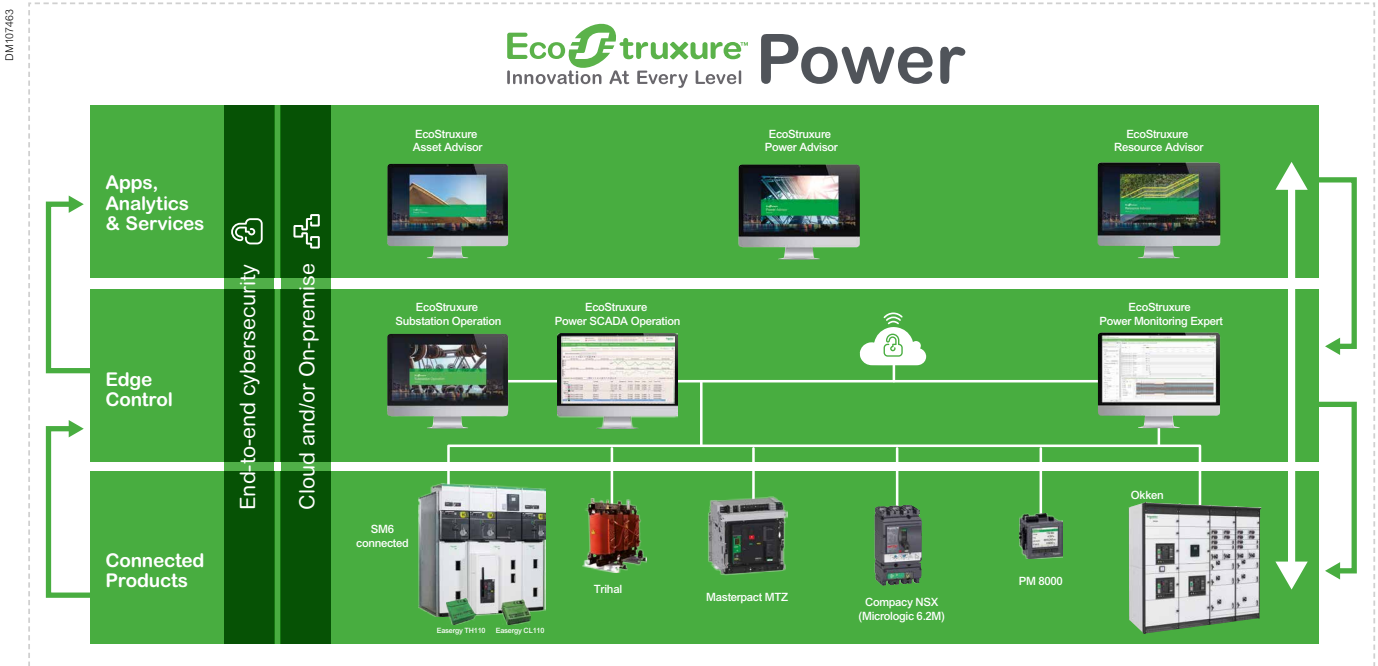

EcoStruxure™ Power digitizes and simplifies low and medium voltage electrical distribution systems. It provides essential data to aid the decisions that help protect people, safeguard assets, maximize operational efficiency and business continuity, and maintain regulatory compliance.

EcoStruxure™ Power is an open architecture and platform designed with the intention of making it easy to add, upgrade, and swap components. The world is full of electrical distribution systems in various stages of maturity, produced by a variety of manufacturers. Interoperability with EcoStruxure™ Power is essential to making these power distributions systems future ready. The added benefit of a holistic Schneider Electric system is plug-and-play connectivity to achieve faster and lower risk integration and commissioning.

EcoStruxure™ Power architectures are cost-optimized to deploy, using only the right technology to deliver the desired business outcomes for our customers – no more, no less. However, customer needs or demands change over time.

The EcoStruxure™ Power system is scalable from light commercial and industrial buildings to critical facilities such as hospitals and data centers, or infrastructure such as airports, rail, and oil and gas. The scalability of EcoStruxure™ Power means it also grows and evolves with changing needs or demands through its modular architecture.

EcoStruxure™ Power architectures are fully flexible power distribution systems with the ability to adapt to dynamic and ever-changing conditions, such as balancing supply and demand by the hour or minute or adding and then scaling on-site renewable generation capabilities over time. Connecting IT and OT systems into a single, easy-to-manage Ethernet IP network is at the heart of our digitization story. With EcoStruxure™ Power, facility managers can use the data they collect to make realtime decisions to maximize business continuity and optimize operations.

More about
EcoStruxure™ Power
se.com/ww/ecostruxure-power



Our SM6 Connected is bringing new functionalities and therefore new opportunities. In parallel, our customer needs are diverse and raise different expectations. For this reason, we have introduced scalable architectures to better meet your needs: **Enabled**, and **Enabled Plus**.

Scalability for fit for purpose solutions

Enabled (Default for all SM6 in the private market)

The Enabled solution as an entry level offer

Thermal sensors factory installed as standard for all the SM6 cubicles having a cable termination for the private market.

Free dedicated "Easergy Thermal Connect" mobile app for Android platforms for on-demand monitoring of the quality of local power connections.



SM6



TH110
thermal sensor



Thermal app

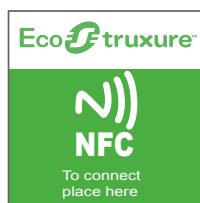

NFC tag

Enabled Plus (Optional)

A comprehensive offer solution with continuous monitoring and real time information

Visibility of switchgear health in real time to reduce unplanned downtime and optimize maintenance OPEX through thermal, condition, and circuit breaker monitoring. Data analysis provides pre-alarming and alarming functions either locally or remotely according to customer requirements.

Enabled Plus solutions also provide **enhanced safety** through features like fast internal arc detection and nearby control.



SM6



Easergy P3

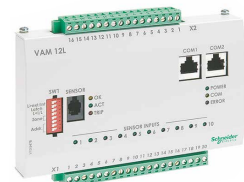

Arc fault detection (VAMP)



TH110
thermal sensor



CL110
environmental sensor

EcoStructure™ ready solutions

IoT-connected MV equipment

SM6 Connected **Enabled**:
Effective asset management



Efficient asset management
Increase uptime while also reducing maintenance costs and risks

Monitor power connection quality, with clear alarm color coding, directly and on demand using your Android smartphone and our **free Easergy Thermal Connect App** available on Google Play.

This solution provides you with reliable (1°C accuracy), fast, and safe thermal monitoring without requiring any infrared camera or thermal windows.

Just plug our Zigbee dongle (included) into your smartphone, flash our NFC tag to set up your app (on first installation only), and start scanning!

DM107466



SM6

Supported by our App to view and share temperature information



Schneider Electric cloud/customer database

Temperature info acquired through the Zigbee protocol into a Zigbee concentrator



TH110 sensor mounted on cable termination



TH110 thermal sensor

EcoStruxure™ ready solutions

IoT-connected MV equipment

SM6 Connected **Enabled**:
Effective asset management



SM6 Connected Enabled

EcoStruxure architecture

The SM6 Connected Enabled architecture is based on TH110 self-power thermal sensors, a Zigbee converter (to plug into the smart device), and the Thermal Connect application. No infrastructure or additional WiFi network is required to perform thermal monitoring in the SM6 substation.



EcoStructure™ ready solutions

IoT-connected MV equipment

SM6 Connected **Enabled Plus**:

Remote monitoring at anytime from anywhere

Optional

- **Enhanced safety**
For both operator and equipment
- **24/7 connectivity**
Real-time remote data for effective decision making, anywhere, anytime
- **Efficient asset management**
Increase uptime while also reducing maintenance costs and risks

Enabled Plus features

Real-time switchgear health condition monitoring with our Substation Monitoring Device providing:

- Local signaling on a Magelis HMI
- Complete data acquisition, analysis, pre-alarming, and alarming
- Thermal monitoring on all your terminal connections detect loose connections
- Environmental monitoring inside the switchgear to avoid premature aging
- Circuit breaker health monitoring
- Nearby control capabilities to operate from a safer distance*
- Open Modbus TCP interface for any SCADA system integration
- GSM modem for SMS smart alarming*
- Fast internal arc detection relay*

*Optional features



EcoStruxure™ ready solutions

IoT-connected MV equipment

SM6 Connected **Enabled Plus**



SM6 Connected Enabled Plus

EcoStruxure architecture

SM6 Connected Enabled Plus architecture is a comprehensive solution of connected switchboard with thermal, environmental, circuit breaker monitoring features. This is an open architecture, ready to connect with in-premises SCADA or remote Schneider Cloud.

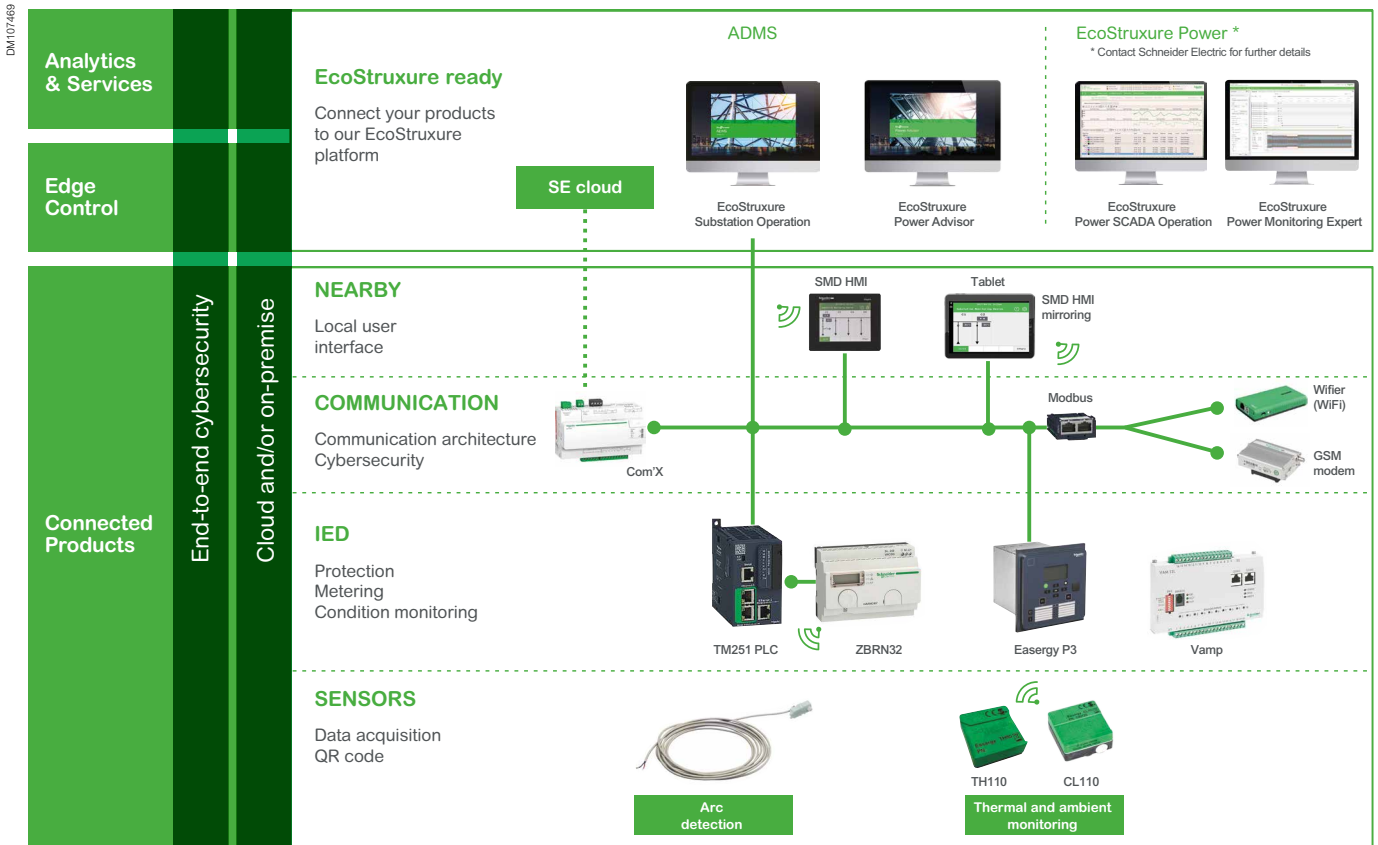

PM108610



Maximize your system investment by making your data work for you

Electrical network reliability, efficiency, and compliance throughout your facility's life cycle

Power Advisor is a unique, affordable and fast-to-deploy service that leverages your power system data. Fueled by analytics and expert engineers, it finds and prioritizes electrical network and data quality issues anywhere in your system, recommending ways to correct them. These automated, expert recommendations shift your team from non-productive hours to high value work via two core categories of analytics:

Data quality

Insights and recommendations that establish a trustworthy data foundation and facilitate ongoing electrical network health

Electrical network

Detailed system and trend summaries that identify weaknesses and propose mitigation solutions to prevent a detrimental impact on your business

How Power Advisor works

Power Advisor analytics are run multiple times per year, dynamically adjusting to changes in your system to ensure optimal system performance.

- Data collection**
 Power system data is collected and uploaded to our secure cloud.
- Single-line diagram**
(recommended for extended analytics)
 A digital representation of your power system hierarchy can be developed. Although this requires an initial setup, only minor adjustments are needed as your system evolves.
- Data quality and electric network analyses**
 Our service experts perform analyses based on your power system and facility configuration.
- Expert consultation**
 Backed by patented analytics, our service experts consult with you to prioritize site issues and review findings.
- Targeted corrective services**
 Based on the results of your expert consultation, prioritized site issues are assessed for mitigation and optimization solutions.
- Follow-up**
 Corrective actions are reviewed to ensure issues are properly resolved with additional guidance provided as needed.

Contact us for more information about how to move to efficient, proactive maintenance with Power Advisor.

Power Advisor digital service plans

Power Advisor digital service plans are designed to pair targeted maintenance with expert support and cutting-edge analytics for measurable improvement of your power system performance. Our plans are offered at different levels to meet your business needs and can be customized with optional services.

Data-driven decisions enable you to maximize your system investment. In fact, IoT-enabled condition-based services can cut unplanned outages in half and reduce maintenance costs by up to 25%, extending the life of your power-related assets.

PM108611



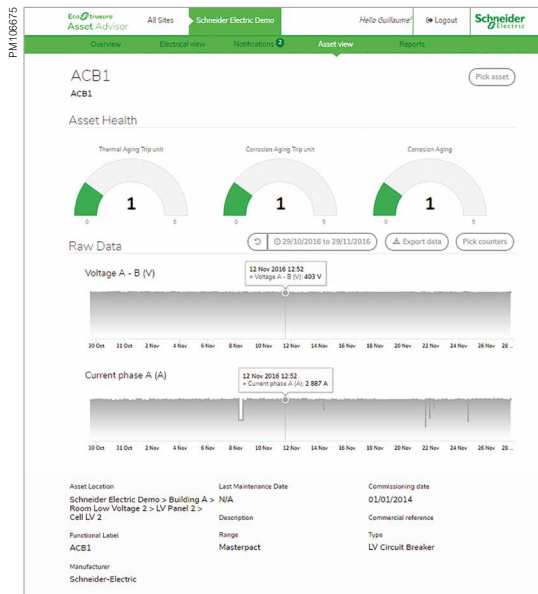

Asset Advisor Dashboard

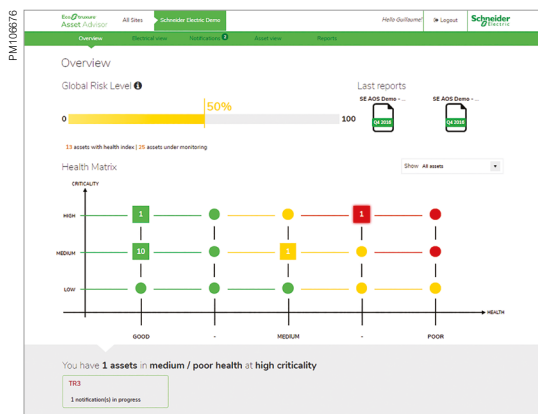

Asset Health Matrix

Schneider Electric approach cybersecurity as a group...

- Data collected through secured gateways
- Secured data transport to prevent data access or manipulation
- Your data is hosted in the Schneider Electric Data Center
- Results displayed on secured dashboard (reports, diagnostics, notifications, etc.)
- You remain the owner of your data

Click [here](#) to download the free version of EcoStruxure Asset Advisor

Apps, analytics and services to improve operational efficiency

Imagine having access to key data about your electrical distribution equipment whenever you need it. And experienced professionals who can help you make better informed decisions.

That is what you get with EcoStruxure Asset Advisor from the Schneider Electric Connected Services.

You know exactly which assets need to be serviced or replaced to help you better plan your expenses.

Are you...

- Planning to introduce condition-based maintenance (beyond corrective and regular maintenance) with benefits associated with reduced time to address an issue?
- Looking for innovative solutions to scale your corporate reliability programs? Mostly started on rotary machines before.
- Striving to dive into IoT complexity with actionable deliverables (not operational alarming)? Or have them defined by the manufacturer?

Our EcoStruxure Asset Advisor solution

- Supports your journey into predictive maintenance
- Is designed to mitigate risk of failure and optimize maintenance
- Turns your data into short-term actions and long-term decisions
- Our platform is ready to use by plug-in connectable electrical assets under our flexible model
- EcoStruxure Asset Advisor brings tangible benefits on failure risk mitigation and maintenance optimization

Operational performance

- Fewer unscheduled downtimes
- Increased asset useful life
- Fewer time to fix
- Better compliance with regulations

Financial efficiency

- Lower total cost of ownership (TCO)
- Decreased failure cost
- Decreased average maintenance cost/fix

Safety

- Reduced personal risk through:
 - Maintenance expertise and continuity in high turnover environment
 - Early warning of impending equipment failure

Peace of mind

- New asset ecosystem insights
- Consistent on-site experience
- Right people at the right time

Schneider Electric's recycling service for SF6 products is part of a rigorous management process.

Environmental performance

Schneider Electric is committed to a long-term environmental approach.

All necessary measures have been taken in conjunction with our services, suppliers and subcontractors to ensure that the materials used in the composition of the equipment do not contain any substances prohibited by regulations and directives.

Schneider Electric's ambition is to reduce the environmental impact of its products throughout their whole life cycle, by offering end-of-life SF6 recycling solutions. Up to 98% of its equipment can be recycled for re-use.



The environmental management system adopted by Schneider Electric production sites that produce the SM6 have been assessed and judged to be in conformity with requirements in the ISO 14001 standard.

Our Air Insulated Switchgear is designed with environmental protection in mind:

- The materials used, insulators and conductors are identified, easily separable and recyclable
- The SF6 can be recovered at the end of the equipment's life and reused after Treatment
- The environmental management system adopted by Schneider Electric's production sites for the manufacture of our Air Insulated Switchgear has been assessed and recognised as conforming to the requirements of the ISO 14001 standard.

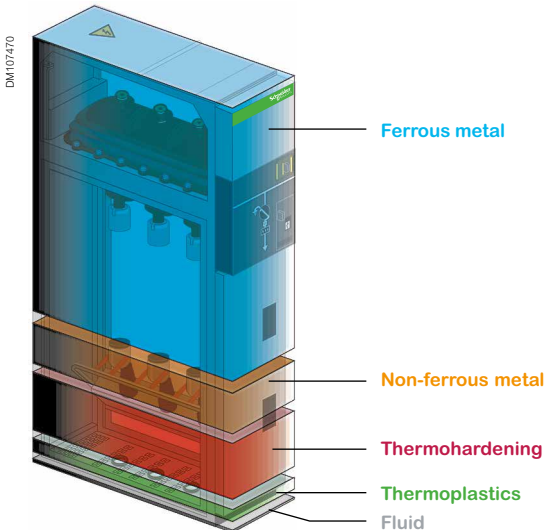

24 kV	
Switch unit	Circuit breaker unit
84%	65%
4%	10.6%
9.5%	22%
2.35%	2.3%
0.15%	0.1%

36 kV	
Switch unit	Circuit breaker unit
74%	82%
8%	7.8%
15%	8%
2%	2%
1%	0.2%

Quality assurance

Quality certified to ISO 9001



A major advantage

Schneider Electric has integrated a functional organisation into each of its units. The main mission of this organisation is to check the quality and the compliance with standards. This procedure is:

- Uniform throughout all departments
- Recognised by many customers and approved organisations.

But it is above all its strict application that has enabled recognition to be obtained by an independent organisation: The **F**rench **Q**uality **A**ssurance **A**ssociation (**FQAA**).

The quality system for the design and manufacture of SM6 units has been certified in conformity with the requirements of the ISO 9001: 2000 quality assurance model.

Meticulous and systematic controls

During manufacture, each SM6 is subject to systematic routine testing which aims to check the quality and conformity:

- Sealing testing
- Filling pressure testing
- Opening and closing rate testing
- Switching torque measurement
- Dielectric testing
- Conformity with drawings and plans.

The results obtained are written and reported on the test certificate for each device by the quality control department.

Mean Operating Time To Failure (MTTF)

As result of Schneider Electric quality assurance system, SM6 has negligible "Mean Down Time (MDT)" in comparison to the "Mean Up Time (MUT)", thus "Mean Operating Time Between Failures (MTBF)" is as similar as to the MTTF.

- MTTF (cumulative) = 3890 years for SM6-24
- MTTF (cumulative) = 6259 years for SM6-36.



Schneider Electric services

Peace of mind throughout your installation life cycle

How can you cut costs and improve performance at the same time?

When it comes to your electrical distribution infrastructure, the answer is straightforward: get professional expertise.

Life Cycle Services

DB400843

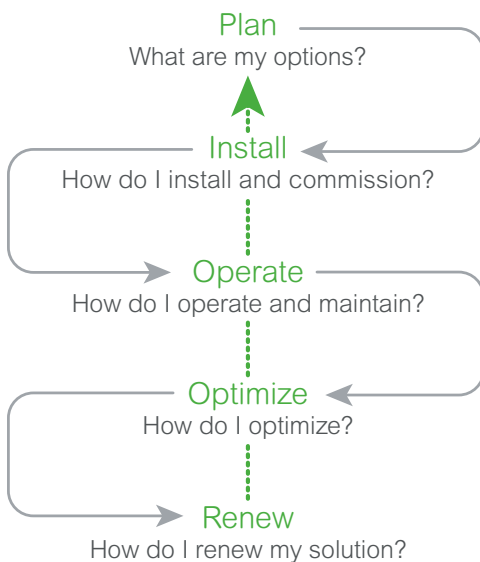

When it comes to your electrical distribution installation, we can help you:

- Increase productivity and reliability
- Mitigate risk and limit downtime
- Keep equipment up to date and extend lifespan
- Cut costs and increase savings
- Improve your return on investment

CONTACT US!

www.schneider-electric.com/b2b/en/services/

Plan

Schneider Electric helps you plan the full design and execution of your solution, looking at how to secure your process and optimize your time:

- **Technical feasibility studies:** Design a solution in your environment
- **Preliminary design:** Accelerate turnaround time to reach a final solution design

Install

Schneider Electric will help you to install efficient, reliable and secured solutions based on your plans.

- **Project management:** Complete your projects on time and within budget
- **Commissioning:** Ensure your actual performance matches the design, through on-site testing and commissioning, and tools and procedures

Operate

Schneider Electric helps you maximize your installation uptime and control your capital expenditure through its service offer.

- **Asset operation solutions:** Provide the information you need to enhance installation performance, and optimize asset maintenance and investment
- **Advantage service plans:** Customize service plans that cover preventive, predictive and corrective maintenance
- **On-site maintenance services:** Deliver extensive knowledge and experience in electrical distribution maintenance
- **Spare parts management:** Ensure spare parts availability and an optimized maintenance budget of your spare parts
- **Technical training:** Build the necessary skills and competencies to properly and efficiently operate your installations

Optimize

Schneider Electric can make recommendations for improved availability, reliability and quality.

- **MP4 electrical assessment of customer installations:** Define an improvement and risk management program

Renew

Schneider Electric extends the life of your system while providing upgrades.

We offer to take full responsibility for the end of life processing of old electrical equipment.

- **ECOFIT™:** Keep up to date and improve the performance of your electrical installations (LV, MV, protection relays, etc.)
- **MV product end of life:** Recycle and recover outdated equipment with end of life services

SM6 24 kV cubicle

Circuit breaker function



Switch function



Fuse-switch function



Other functions



SM6 36 kV cubicle

Circuit breaker function



Switch function



Fuse-switch function



Other functions



General characteristics

General characteristics

Field of application	30
Units for switching function	32
Units for protection function	33
Units for metering function	36
Units for other functions	37
Operating conditions	38
Standards	39
Main characteristics	40
Factory-built cubicles description	43
Compartments and devices description	46
Safety of people	49
By switchgear	49
By operating mechanism safety	51
By internal arc protection	52

The SM6 is made up of modular units containing fixed, disconnectable or withdrawable metal-enclosed switchgear, using sulphur hexafluoride (SF6) or vacuum:

- Switch-disconnector
- SF1, SFset or Evolis circuit breaker
- Vacuum contactor
- Disconnecter.

SM6 units are used for the MV section in MV/LV transformer substations in public distribution systems and MV consumer or distribution substations up to 36 kV.

MV/LV transformer substations

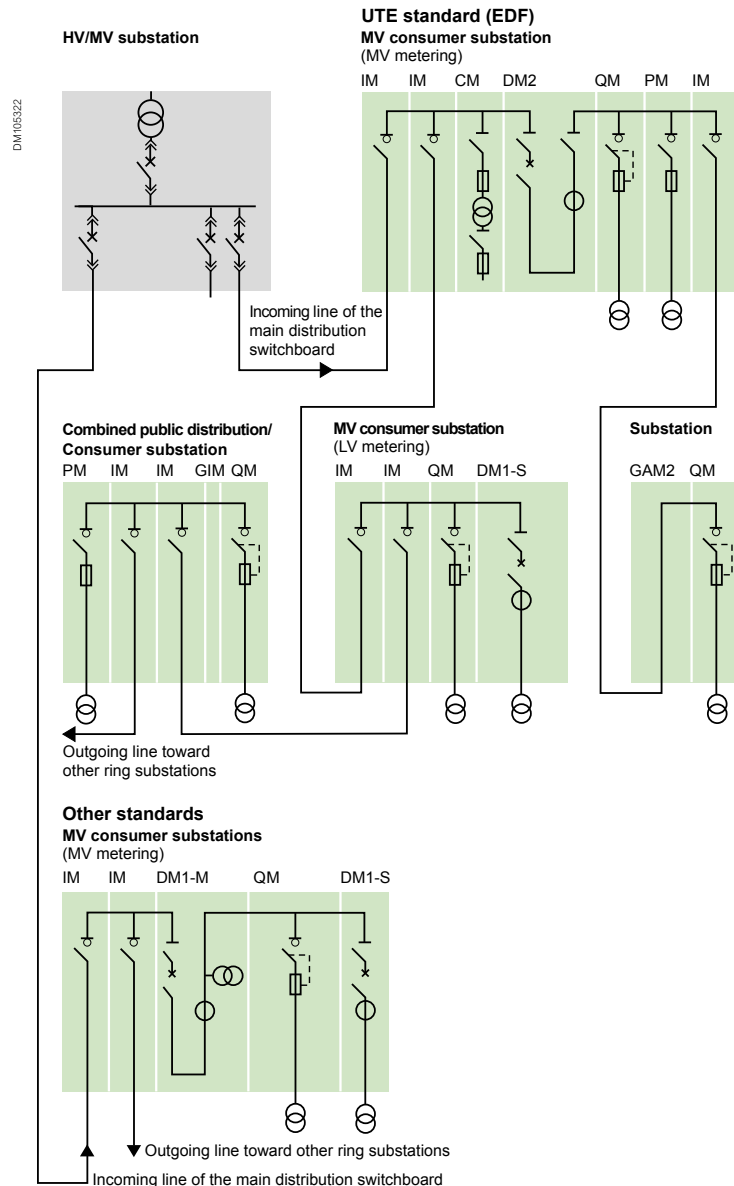

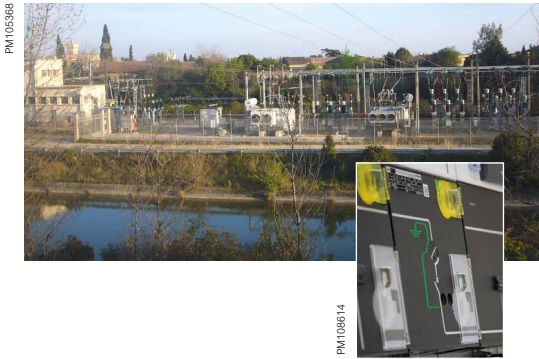

Industrial distribution substations

Unit definitions

Below is the list of SM6 units used in MV/LV transformer substations and industrial distribution substations:

- **IM, IMC, IMB, IMM** switch
- **PM** fused switch
- **QM, QMC, QMB** fuse-switch combination
- **CVM** contactor and contactor with fuses
- **DM1-M, DM1-A, DM1-D, DM1-S** single-isolation disconnectable SF6 type circuit breaker
- **DMV-A, DMV-D**, single-isolation vacuum type circuit breaker frontal
- **DMVL-A, DMVL-D** single-isolation disconnectable vacuum type circuit breaker lateral
- **DM1-W, DM1-Z** withdrawable single-isolation SF6 type circuit breaker for SM6-24
- **DM2** double-isolation disconnectable SF6 type circuit breaker
- **CM, CM2** voltage transformers
- **GBC-A, GBC-B** current and/or voltage measurements
- **NSM-cables** for main incoming and standby
- **NSM-busbars** for main incoming and cables for standby
- **GIM** intermediate bus unit
- **GEM** extension unit
- **GBM** connection unit
- **GAM2, GAM** incoming cable connection unit
- **SM** disconnecter
- **TM** MV/LV transformer unit for auxiliaries
- Other units, consult us
- Special function **EMB** busbar earthing only for SM6-24

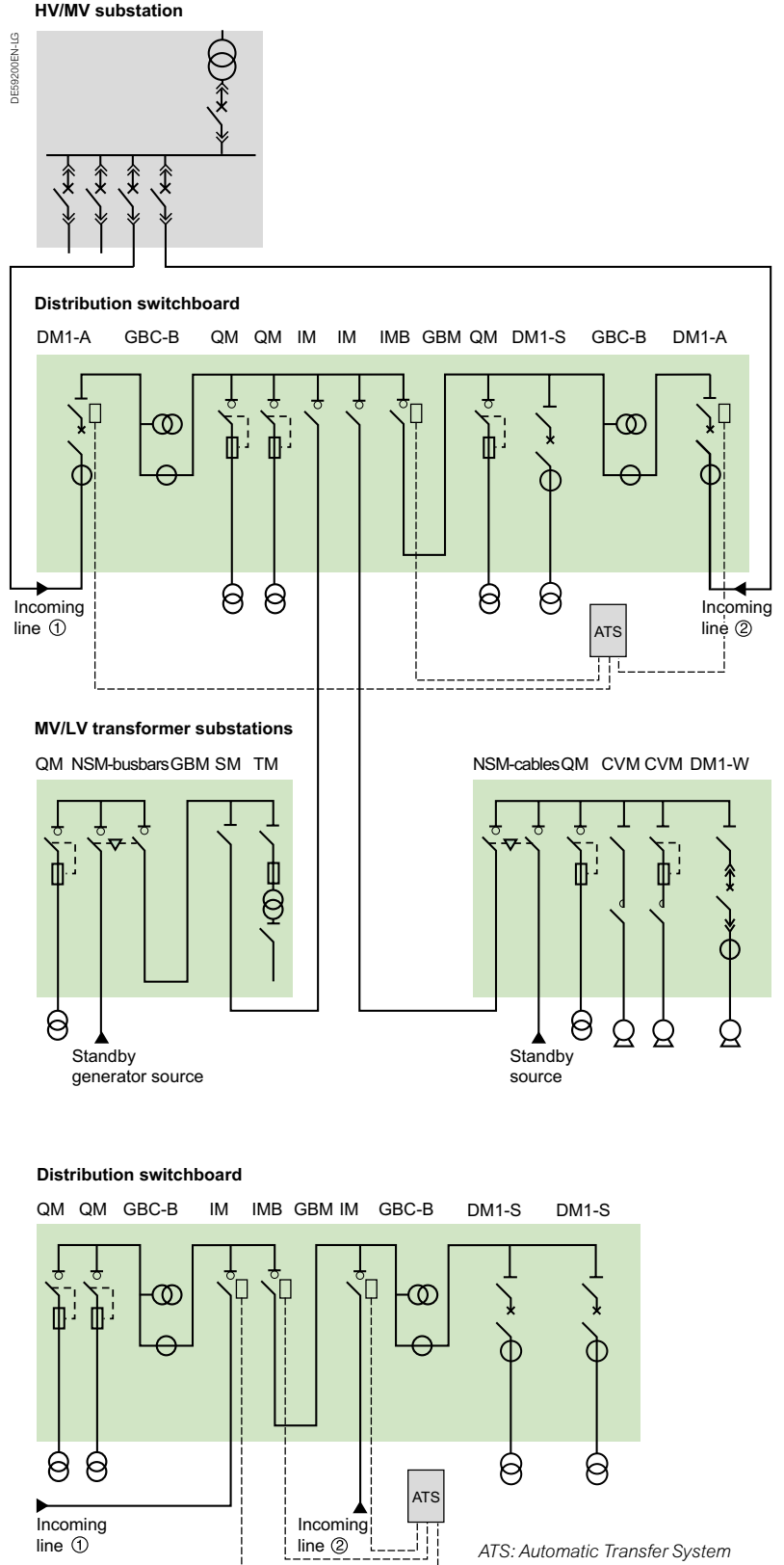

Switching

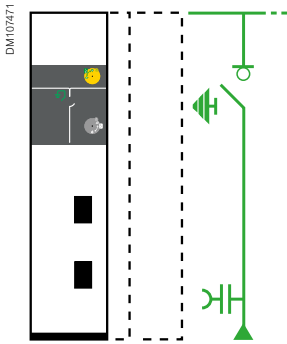

IM
Switch unit
SM6-24: 375 or 500 mm
SM6-36: 750 mm

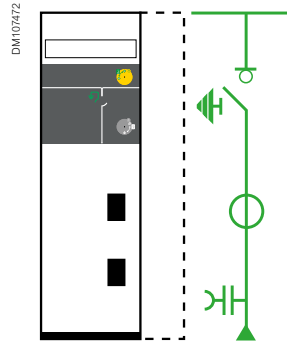

IMC
Switch unit
SM6-24: 500 mm
SM6-36: 750 mm

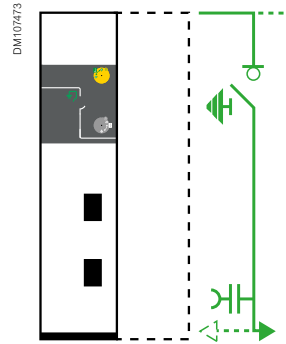

IMB
Switch unit with earthing disconnect, right or left outgoing line
SM6-24: 375 mm
SM6-36: 750 mm

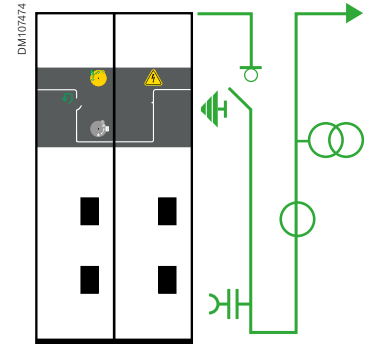

IMM
Switch and measurement unit, right or left outgoing line
SM6-24: 750 mm

Automatic transfer system

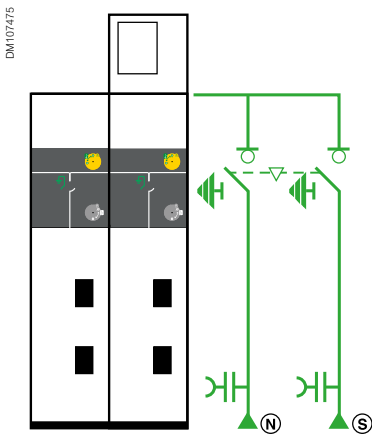

NSM-cables
Cables power supply for main incoming line and standby line
SM6-24: 750 mm

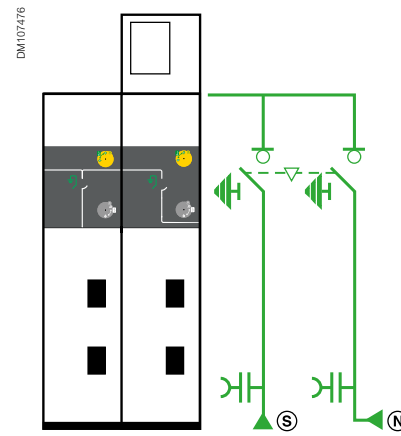

NSM-busbars
Busbars power supply for main incoming line on right or left and cables for standby line
SM6-24: 750 mm

Fuse-switch

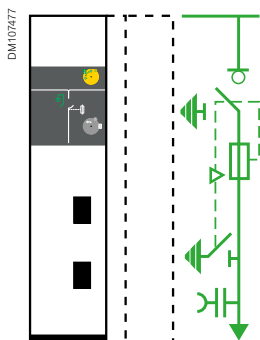

QM
Fuse-switch combination unit
 SM6-24: 375 or 500 mm
 SM6-36: 750 mm

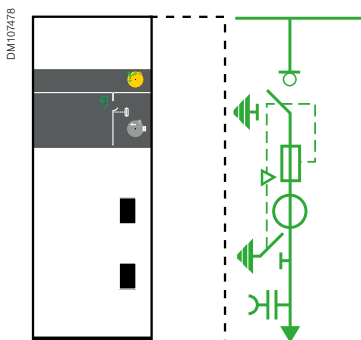

QMC
Fuse-switch combination unit
 SM6-24: 625 mm
 SM6-36: 1000 mm

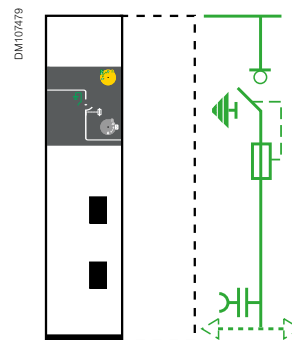

QMB
Fuse-switch combination unit right or left outgoing line
 SM6-24: 375 mm
 SM6-36: 750 mm

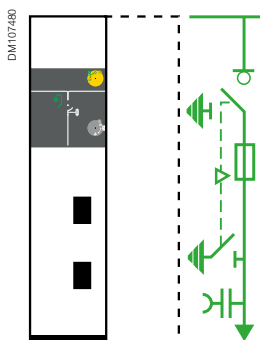

PM
Fuse-switch unit
 SM6-24: 375 mm
 SM6-36: 750 mm

SF6 circuit-breaker

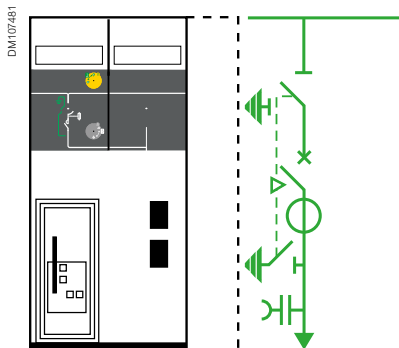

DM1-A
Single-isolation, disconnectable circuit breaker unit
 SM6-24: 750 mm
 SM6-36: 1000 mm

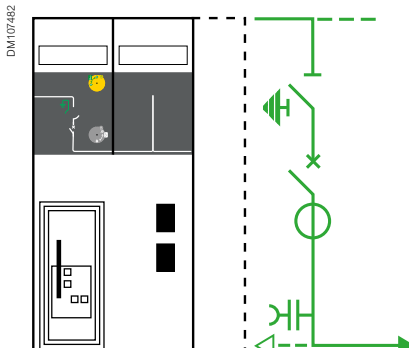

DM1-D
Single-isolation, disconnectable circuit breaker unit right or left outgoing line
 SM6-24: 750 mm
 SM6-36: 1000 mm

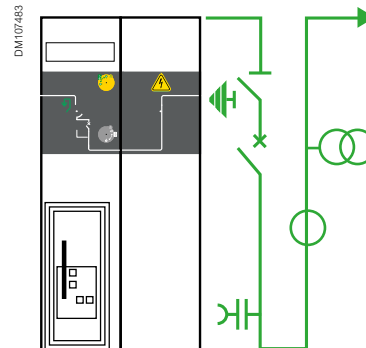

DM1-M
Single-isolation, disconnectable circuit breaker and measurement unit right outgoing line
 SM6-24: 750 mm

SF6 circuit-breaker

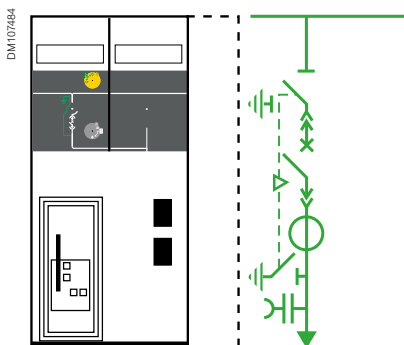

DM1-W
Withdrawable single-isolation
circuit breaker unit
 SM6-24: 750 mm

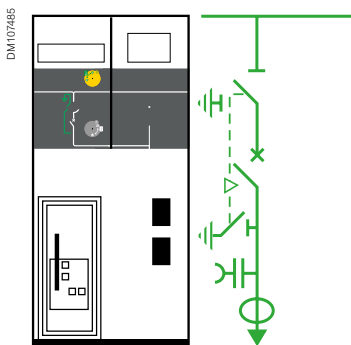

DM1-S
Single-isolation, disconnectable
circuit breaker unit with
autonomous protection
 SM6-24: 750 mm

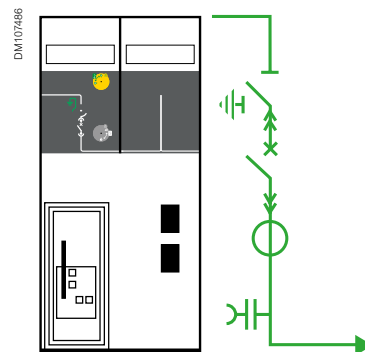

DM1-Z
Withdrawable single-isolation
circuit breaker unit
right outgoing line
 SM6-24: 750 mm

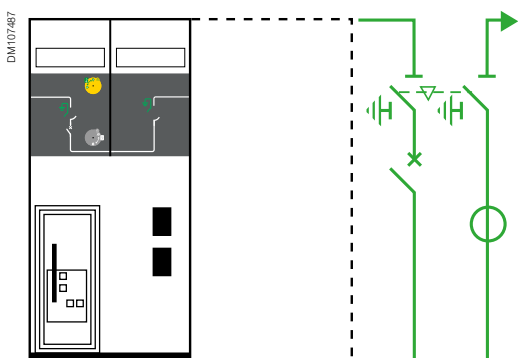

DM2
Double-isolation, disconnectable
circuit breaker unit right or left
outgoing line
 SM6-24: 750 mm
 SM6-36: 1500 mm

Vacuum circuit-breaker

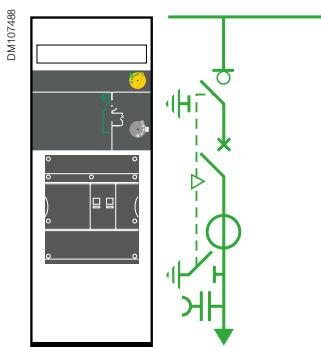

DMV-A
Single-isolation circuit breaker
unit
 SM6-24: 625 mm

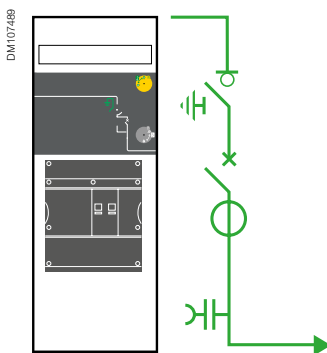

DMV-D
Single-isolation circuit breaker
unit right outgoing line
 SM6-24: 625 mm

Units for protection function

Vacuum circuit-breaker

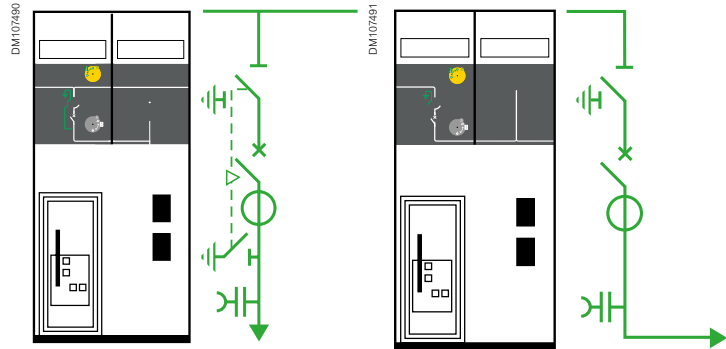

DMVL-A
Single-isolation, disconnectable circuit breaker unit
 SM6-24: 750 mm

DMVL-D
Single-isolation, disconnectable circuit breaker unit right outgoing line
 SM6-24: 750 mm

Vacuum contactor (Direct Motor Starter)

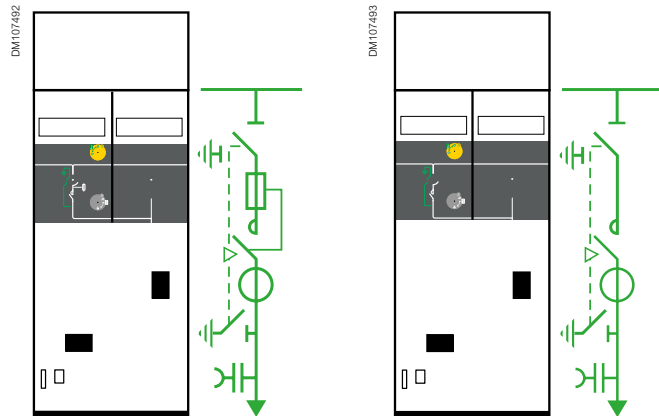

CVM
Fuse-contactor unit
 SM6-24: 750 mm

CVM
Contactor unit
 SM6-24: 750 mm

Units for metering function

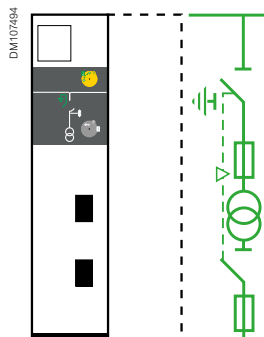

CM
Voltage transformers for mains with earthed neutral system

SM6-24: 375 mm
SM6-36: 750 mm

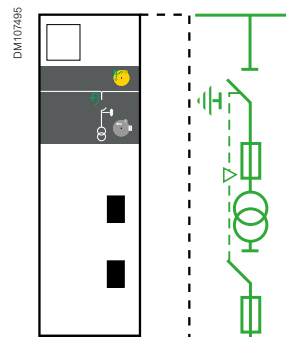

CM2
Voltage transformers for mains with insulated neutral system

SM6-24: 500 mm
SM6-36: 750 mm

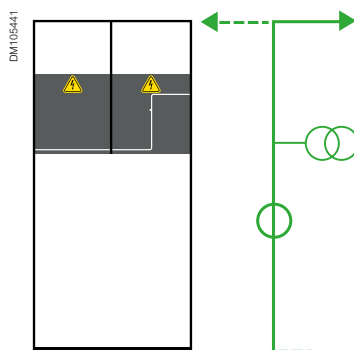

GBC-A
Current and/or voltage measurement unit right or left outgoing line

SM6-24: 750 mm
SM6-36: 750 mm

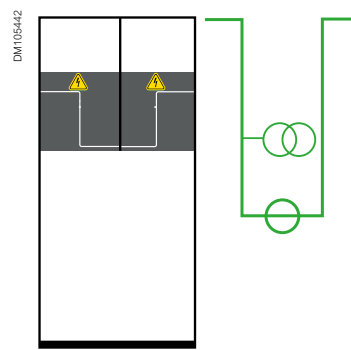

GBC-B
Current and/or voltage measurement unit

SM6-24: 750 mm
SM6-36: 750 mm

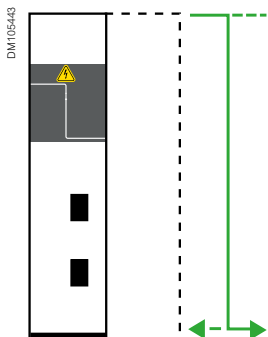

GBM
Connection unit
right or left outgoing line
 SM6-24: 375 mm
 SM6-36: 750 mm

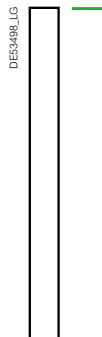

GEM
Extension unit VM6/SM6
 SM6-24: 125 mm

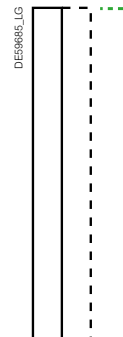

GIM
Intermediate bus unit
 SM6-24: 125 mm
 SM6-36: 250 mm

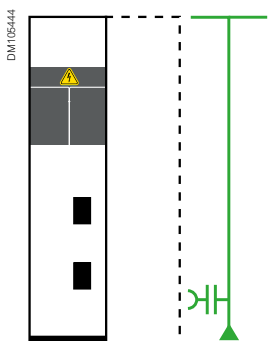

GAM2
Incoming cable-connection unit
 SM6-24: 375 mm
 SM6-36: 750 mm

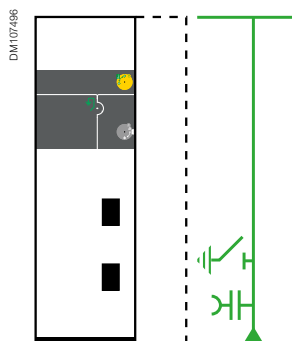

GAM
Incoming cable-connection unit with earthing
 SM6-24: 500 mm
 SM6-36: 750 mm

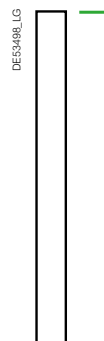

GMM
Extension unit Modularc/ SM6-36
 SM6-36: 250 mm

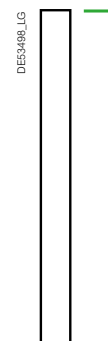

GUM
Extension unit Unifluorc/ SM6-24
 SM6-24: 125 mm

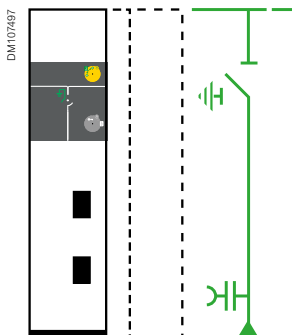

SM
Disconnecter unit
 SM6-24: 375 mm or 500⁽¹⁾ mm
 SM6-36: 750 mm
(1) only for 1250 A units.

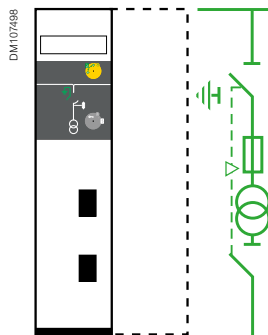

TM
MV/LV transformer unit for auxiliaries
 SM6-24: 375 mm
 SM6-36: 750 mm

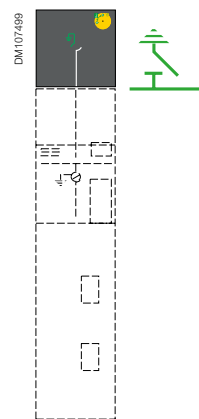

EMB
Busbar earthing enclosure
 SM6-24: 375 mm

In addition to its technical characteristics, SM6 meets requirements concerning safety of life and property as well as ease of installation, operation and protecting the environment.

SM6 units are designed for indoor installations.

Their compact dimensions are:

- 375 to 1500 mm width
- 1600 to 2250 mm height
- 840 to 1400 mm depth...

... this makes for easy installation in small rooms or prefabricated substations.

Cables are connected via the front.

All control functions are centralised on a front plate, thus simplifying operation.

The units may be equipped with a number of accessories (relays, toroids, instrument transformers, surge arrester, control and monitoring, etc.).

Normal operating conditions

Ambient air temperature

- Less than or equal to 40°C
- Less than or equal to 35°C on average over 24 hours
- Greater or equal to -5°C.

Altitude

- Less than or equal to 1000 m
- Above 1000 m, a derating coefficient is applied (please consult us).

Solar radiation

- No solar radiation influence is permitted.

Ambient air pollution

- No significant pollution by dust, smoke, corrosive and/or flammable gases, vapours or salt.

Humidity

- Average relative humidity over a 24 hour period, less than or equal to 95%
- Average relative humidity over a 1 month period, less than or equal to 90%
- Average vapor pressure over a 24 hour period, less than or equal to 2.2 kPa
- Average vapor pressure over a 1 month period, less than or equal to 1.8 kPa.

For these conditions, condensation may occasionally occur. Condensation can be expected where sudden temperature changes occur in periods of high humidity.

To withstand the effects of high humidity and condensation, such as breakdown of insulation, please pay attention on Civil Engineering recommendations for design of the building or housing, by suitable ventilation and installation.

Seismic (for 24 Kv and 36 kV):

- Up to 0.5 g (horizontal) and 0.4 g (vertical)
- Class 2 for 24 kV and Class 1 for 36kV
- According to standards IEEE-693/2005 and EN 60068-3/1993 for the 24 kV and 36 kV

Severe operating conditions (please consult us).

PM108615



SM6 units meet all the following standards and specifications:

- IEC standards
- UTE standards for SM6-24
- EDF specifications for SM6-24
- SEISMIC standards for 24 kV

IEC standards

62271-200	High-voltage switchgear and controlgear - Part 200: A.C. metal-enclosed switchgear and controlgear for rated voltage above 1 kV and up to and including 52 kV.
62271-1	High-voltage switchgear and controlgear - Part 1: Common specifications.
62271-103	High voltage switches - Part 1: switches for rated voltages above 1 kV and less or equal to 52 kV.
62271-105	High-voltage switchgear and controlgear - Part 105: High voltage alternating current switch-fuse combinations.
60255	Electrical relays.
62271-100	High-voltage switchgear and controlgear - Part 100: High-voltage alternating current circuit breakers.
62271-102	High-voltage switchgear and controlgear - Part 102: High-voltage alternating current disconnectors and earthing switches.
61869-2	Instrument transformers - Part 1: Current transformers.
61869-3	Instrument transformers - Part 2: Voltage transformers.
60044-8	Instrument transformers - Part 8: Low Power Current Transducers.
62271-206	High-voltage prefabricated switchgear and controlgear assemblies - Voltage presence indicating systems.
62271-304	High-voltage switchgear and controlgear - Part 304: Design classes for indoor enclosed switchgear and controlgear for rated voltages above 1 kV up to and including 52 kV to be used in severe climatic conditions.

SEISMIC standards for 24kV

IEE-693	2005 IEEE Recommended Practice for Seismic Design of Substations
EN600068-3-3	1993 Environmental testing-Part 3: guidance, Seismic test methods for equipments

UTE standards for 24 kV

NFC 13.100	Consumer substation installed inside a building and fed by a second category voltage public distribution system.
NFC 13.200	High voltage electrical installations requirements.
NFC 64.130	High voltage switches for rated voltage above 1 kV and less than 52 kV.
NFC 64.160.	Alternating current disconnectors and earthing switches

PW100616



The hereunder values are for working temperatures from -5°C up to +40°C and for a setting up at an altitude below 1000 m.

Electrical characteristics

Rated voltage	Ur	kV	7.2	12	17.5	24	36	
Insulation level								
Insulation	Ud	50/60 Hz, 1 min (kV rms)	20	28	38	50	70	
Isolation	Ud	50/60 Hz, 1 min (kV rms)	23	32	45	60	80	
Insulation	Up	1.2/50 μs (kV peak)	60	75	95	125	170	
Isolation	Up	1.2/50 μs (kV peak)	70	85	110	145	195	
Breaking capacity								
Transformer off load		A	16					
Cables off load		A	31.5					50
Rated current	Ir	A	400 - 630 - 1250					630-1250
Short-time withstand current	Ik/tk ⁽¹⁾	kA/1 s	25	630 - 1250				1250
			20 ⁽²⁾	630 - 1250				
			16	630 - 1250				
			12.5	400 - 630 - 1250				630-1250
Making capacity (50 Hz)	Ima	kA	62.5	630		NA		
			50	630				
			40	630				
			31.25	400 - 630				630
Maximum breaking capacity (Isc)								
Units IM, IMC, IMB, IMM		A	630 - 800 ⁽³⁾				630	
NSM-cables, NSM-busbars		A	630 - 800 ⁽³⁾				NA	
QM, QMC, QMB		kA	25		20		20	
PM		kA	25				20	
CVM		kA	6.3	NA				
CVM with fuses		kA	25	NA				
SF6 circuit breaker range			7.2	12	17.5	24	36	
DM1-A, DM1-D, DM1-W		kA	25	630-1250				1250
			20	630-1250				
DM1-S, DM1-M		kA	25	630				NA
DM1-Z			25	1250				NA
DM2		kA	20	630				
			25	630				1250
Vacuum circuit breaker range			7.2	12	17.5	24	36	
DMV-A, DMV-D		kA	25	630-1250			NA	
DMVL-A		kA	20	630				NA
DMVL-D		kA	25	630				NA

NA: Non Available

(1) 3 phases

(2) In 20 kA / 3 s for SM6-24 only, consult us

(3) In 800 A, consult us.



Endurance

Units		Mechanical endurance	Electrical endurance
IM, IMC, IMB, IMM, PM, QM ⁽¹⁾ , QMC ⁽¹⁾ , QMB ⁽¹⁾ , NSM-cables, NSM-busbars		IEC 62271-103 1 000 operations class M1	IEC 62271-103 100 breaks at I _r , p.f. = 0.7, class E3
CVM	Disconnecter	IEC 62271-102 1 000 operations	
	Vacuum contactor	IEC 60470 2 500 000 operations 250 000 with mechanical latching	IEC 60470 250 000 breaks at I _r
SF6 circuit breaker range			
DM1-A, DM1-D, DM1-M, DM1-W, DM1-Z, DM1-S, DM2	Disconnecter	IEC 62271-102 1 000 operations	
	SF circuit breaker	IEC 62271-100 10 000 operations class M2	IEC 60271-016 30 breaks at 12.5 kA for SM6-24 25 breaks at 25 kA for SM6-24 40 breaks at 16 kA for SM6-36 15 breaks at 25 kA for SM6-36 10 000 breaks at I _r , p.f. = 0.7, class E2
		Operating sequence	O - 0.3 s - CO - 15 s - CO O - 0.3 s - CO - 3 mn O - 3 mn - CO - 3 mn - CO
Vacuum circuit breaker range			
DMV-A, DMV-D	Switch	IEC 62271-103 1 000 operations class M1	IEC 62271-103 100 breaks at I _r , p.f. = 0.7, class E3
	Evolis circuit breaker	IEC 62271-100 10 000 operations class M2	IEC 62271-100 100 breaks at 25kA for SM6-24 10 000 breaks at I _r , p.f. = 0.7, class E2
DMVL-A, DMVL-D	Disconnecter	IEC 62271-102 1 000 operations	
	Evolis circuit breaker	IEC 62271-100 10 000 operations class M2	IEC 62271-100 100 breaks at 16kA for SM6-24 100 breaks at 25kA for SM6-24 10 000 breaks at I _r , p.f. = 0.7, class E2

⁽¹⁾ As per recommendation IEC 62271-105, three breakings at p.f. = 0.2
800 A under 36 kV; 1400 A under 24 kV; 1730 A under 12 kV; 2600 A under 5.5 kV.

Internal arc withstand (in accordance with IEC 62271-200)

SM6-24	Basic	<ul style="list-style-type: none"> • 12.5 kA 1 s, IAC: A-FL • 12.5 kA 1 s, IAC: A-FLR
	Advance	<ul style="list-style-type: none"> • 16 kA 1 s, IAC: A-FLR & IAC: A-FL • 20 kA 1 s, IAC: A-FLR & IAC: A-FL
SM6-36		<ul style="list-style-type: none"> • 16 kA 1 s, IAC: A-FL

Protection index

- Classes: PI (insulating partition)
- Loss of service continuity classes: LSC2A (LSC1 for metering GAM/GBM functions)
- Units in switchboard: IP3X
- Between compartments: IP2X for SM6-24, IP2XC for SM6-36
- Cubicle: IK08 for SM6-24, IK07 for SM6-36.

Electro-magnetic compatibility

- Relays: 4 kV withstand capacity, as per recommendation IEC 60801.4
 - Compartments:
 - Electrical field:
 - 40 dB attenuation at 100 MHz
 - 20 dB attenuation at 200 MHz
 - Magnetic field:
 - 20 dB attenuation below 30 MHz
- According to standards IEEE-693/2005 and EN 60068-3/1993

- **For 36 kV** (please contact us).

Temperatures

The cubicles must be stored and installed in a dry area free from dust and with limited temperature variations.

- For storage: from -40°C to +70°C
- For working: from -5°C to +40°C
- Other temperatures, consult us.

Seismic for 24 kV (option)

- Up to 0.5 g (horizontal) and 0.4 g (vertical)
- Class 2

Factory-built cubicles description

DE58646b

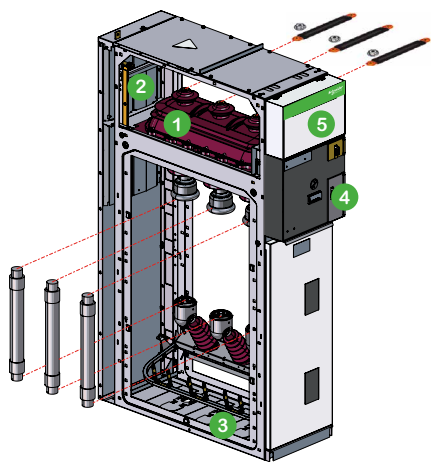

Switch and fuse protection cubicles

- 1 Switchgear** Switch-disconnector and earthing switch in an enclosure filled with SF6 and satisfying "sealed pressure system" requirements
- 2 Busbars** All in the same horizontal plane, thus enabling later switchboard extensions and connection to existing equipment.
- 3 Connection** Accessible through front, connection to the lower switch-disconnector and earthing switch terminals (IM cubicles) or the lower fuse-holders (PM and QM cubicles). This compartment is also equipped with an earthing switch downstream from the MV fuses for the protection units.
- 4 Operating mechanism** Contains the elements used to operate the switch-disconnector and earthing switch and actuate the corresponding indications (positive break).
- 5 Low voltage** Installation of a terminal block (if motor option installed), LV fuses and compact relay devices. If more space is required, an additional enclosure may be added on top of the cubicle.

Options: Please, refer to the chapter "Characteristics of the functional units".

DE58647b

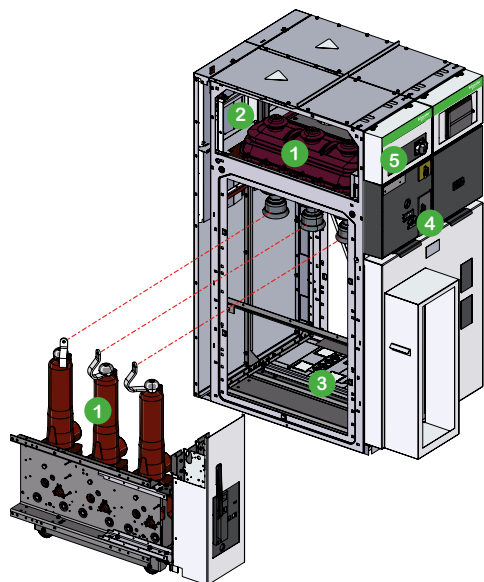

SF6 circuit breaker cubicles

- 1 Switchgear** Disconnector(s) and earthing switch(es), in enclosures filled with SF6 and satisfying "sealed pressure system" requirements.
- 2 Busbars** All in the same horizontal plane, thus enabling later switchboard extensions and connection to existing equipment.
- 3 Connection and switchgear** Accessible through front, connection to the downstream terminals of the circuit breaker.
Two circuit breaker offers are possible:
 - SF1: combined with an electronic relay and standard sensors (with or without an auxiliary power supply)
 - SFset: autonomous set equipped with an electronic protection system and special sensors (requiring no auxiliary power supply).
- 4 Operating mechanism** Contains the elements used to operate the disconnector(s), the circuit breaker and the earthing switch and actuate the corresponding indications.
- 5 Low voltage** Installation of compact relay devices (Statimax) and test terminal boxes. If more space is required, an additional enclosure may be added on top of the cubicle.

Options: Please, refer to the chapter "Characteristics of the functional units".

Factory-built cubicles description

DE59648b

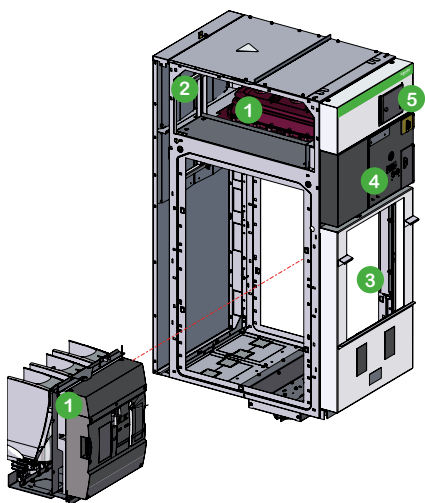

Frontal vacuum type circuit breaker cubicles

- 1 Switchgear** Load break switch and earthing switch(es), in enclosure filled with SF6 and satisfying and one vacuum circuit breaker, "sealed pressure system" requirements
- 2 Busbars** All in the same horizontal plane, thus enabling later switchboard extensions and connection to existing equipment.
- 3 Connection and switchgear** Accessible through front, connection to the downstream terminals of the circuit breaker.
Evolis: device associated with an electronic relay and standard sensors (with or without auxiliary source).
- 4 Operating mechanism** Contains the elements used to operate the disconnecter(s), the circuit breaker and the earthing switch and actuate the corresponding indications.
- 5 Low voltage** Installation of compact relay devices (VIP) and test terminal boxes.
If more space is required, an additional enclosure may be added on top of the cubicle

Options: Please, refer to the chapter "Characteristics of the functional units".

DE59649b

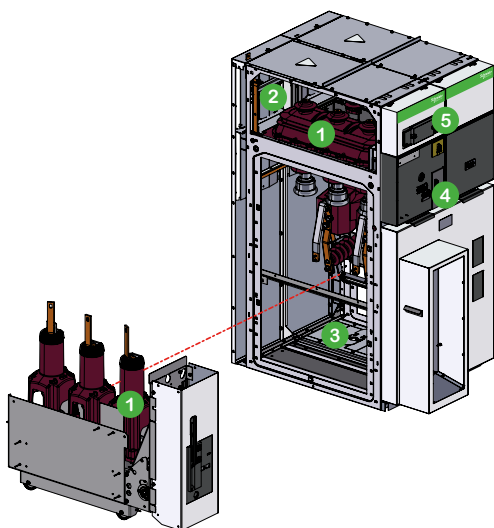

Lateral vacuum type circuit breaker cubicles

- 1 Switchgear** Disconnecter(s) and earthing switch(es), in enclosure filled with SF6 and satisfying and one vacuum circuit breaker, "sealed pressure system" requirements.
- 2 Busbars** All in the same horizontal plane, thus enabling later switchboard extensions and connection to existing equipment.
- 3 Connection and switchgear** Accessible through front, connection to the downstream terminals of the circuit breaker.
Evolis: device associated with an electronic relay and standard sensors (with or without auxiliary source).
- 4 Operating mechanism** Contains the elements used to operate the disconnecter(s), the circuit breaker and the earthing switch and actuate the corresponding indications.
- 5 Low voltage** Installation of compact relay devices (VIP) and test terminal boxes.
If more space is required, an additional enclosure may be added on top of the cubicle.

Options: Please, refer to the chapter "Characteristics of the functional units".

Factory-built cubicles description

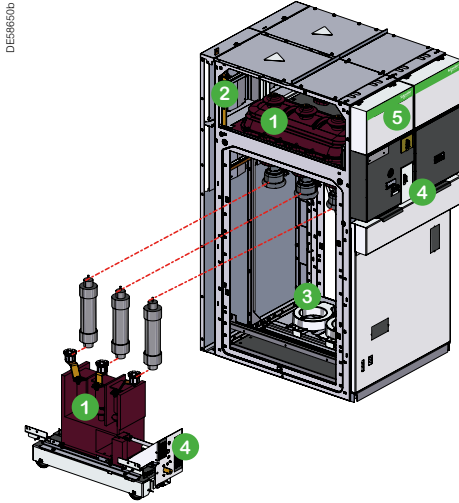

Contactor cubicles

- 1 Switchgear** Disconnecter and earthing switch and contactor in enclosures filled with SF6 and satisfying "sealed pressure system" requirements.
- 2 Busbars** All in the same horizontal plane, thus enabling later switchboard extensions and connection to existing equipment.
- 3 Connection and switchgear** Accessible through front. It is also equipped with an earthing switch downstream. The contactor may be equipped with fuses. 2 types may be used:
 - Vacuum with magnetic holding
 - Vacuum with mechanical latching.
- 4 Operating mechanism** Contains the elements used to operate the disconnecter(s), the contactor and the earthing switch and actuate the corresponding indications.
- 5 Low voltage** Installation of compact relay devices and test terminal boxes. With basic equipment, an additional enclosure is added on top of the cubicle.

Options: Please, refer to the chapter "Characteristics of the functional units".

Compartments and devices description

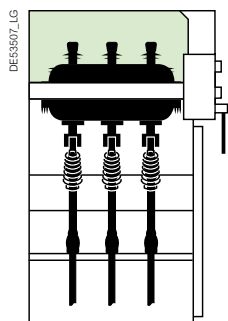

Busbar compartment

The three insulated busbars are parallel-mounted. Connection is made to the upper pads of the enclosure using a field distributor with integrated captive screws. Ratings 400 (for SM6-24 only) - 630 - 1250 A.

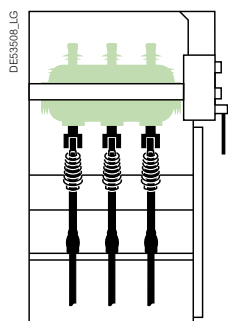

Switching device

This device is separated from the busbar compartment and the connection compartment by the enclosure surrounding the switch, the disconnector and the earthing switch.

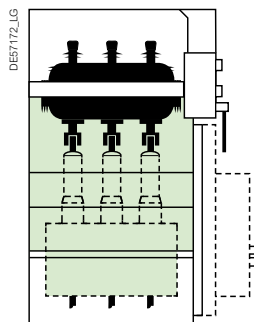

SF6 and vacuum lateral type circuit breaker

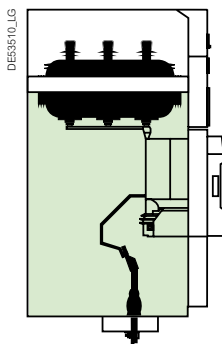

Frontal vacuum type circuit breaker

Connection compartment

The network cables are connected:

- To the terminals of the switch
- To the lower fuse holders
- Or to the connection pads of the circuit breaker.

Cables may have either:

- Cold fitted cable end for dry-type

With basic equipment, the maximum allowable cross-section for cable is:

- 630 mm² or 2 x 400 mm² for 1250 A incoming or outgoing units
- 240 mm² or 2 x 240 mm² for incoming or outgoing units 400 - 630 A
- 95 mm² for transformer protection cubicles incorporating fuses.

See in functional units characteristics chapter for each unit allowable section. / The earthing switch must be closed before the cubicle may be accessed. / The reduced depth of the cubicle makes for easy connection of all phases. / A stud incorporated in the field distributor makes it possible to position and secure the cable-end lug with a single hand.

Compartments and devices description

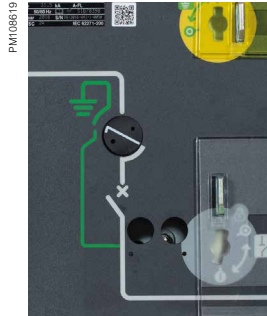
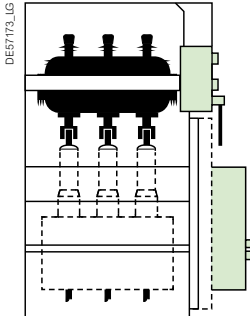

Operating-mechanism cover

These covers contain the various operating functions for the:

- Switch and earthing switch
- Disconnecter(s)
- Circuit breaker
- Contactor

and the voltage presence indicator.

The operating-mechanism cover may be accessed with the cables and busbars energised and without isolating the substation. It also enables easy installation of padlocks, locks and standard LV accessories (auxiliary contacts, trip units, motors, etc.).



Low-voltage monitoring control cabinet for SM6-24

It enables the cubicle to be equipped with low voltage switchgear providing protection, control, status indication and data transmission.

According to the volume, it is available in 3 versions: cover, wiring duct and cabinet.

A	B1	B2	C
LV cover	LV wiring duct	LV wiring duct	LV control cabinet
Height (mm):			
1600	1690	1840	2050
Low Voltage option			
	90	240	450

A LV cover: Enables a very simple low voltage section to be installed such as indication buttons, push buttons or protection relays.

B1 LV wiring duct and cabinet: Enables a large majority of low voltage configurations to be installed. It also takes the Easergy Sepam series 20 or series 40.

B2 LV wiring duct and cabinet (240 mm): Enables a large majority of low voltage to be installed. It also takes the thermal monitoring, VAMP121.

C LV control cabinet: This is only used for larger low voltage accessories or those with a depth greater than 100 mm or complex equipment, such as Easergy Sepam series 60 or series 80, converters, control and monitoring units, regulating transformers or dual secondary transformers.

In all cases, these volumes are accessible, with cables and busbars energised, without de-energising the substation.

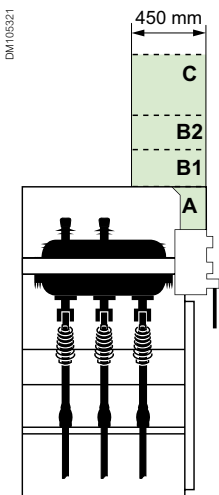

Compartments and devices description



Low-voltage monitoring control cabinet for SM6-36

- A LV cover:** Enables a very simple low voltage section to be installed such as indication buttons, push buttons or protection relays. The total height of the cubicle is then 2250 mm.
- B LV control cabinet:** This can be used for larger low voltage accessories or those with a depth greater than 100 mm or complex equipment, such as Easergy Sepam series 60 or series 80, converters, control and monitoring units, regulating transformers or dual secondary transformers.

In all cases, these volumes are accessible, with cables and busbars energised, without de-energising the substation.

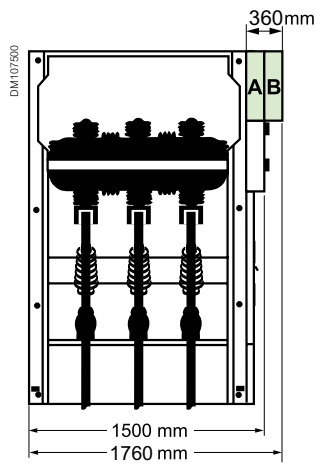

Safety of people

By switchgear

Inensitivity to the environment

- Parts are designed in order to obtain optimum electrical field distribution.
- The metallic structure of cubicles is designed to withstand and aggressive environment and to make it impossible to access any energised part when in operation.



Switch-disconnector for 24 kV



Switch-disconnector for 36 kV



SF1 circuit breaker

Switch or disconnector and earthing switch

Gas tightness

The three rotating contacts are placed in an enclosure filled with gas to a relative pressure of 0.4 bar (400 hPa) for SM6-24 and 1 bar (1000 hPa) for SM6-36. It satisfies "sealed pressure system" requirements and seal tightness is always factory checked, and leakage rate is less than 0.1% for 30 years life span.

Operating safety

- The switch may be in one of three positions: "closed", "open", or "earthed", representing a natural interlocking system that prevents incorrect operation. Moving-contact rotation is driven by a fast-acting mechanism that is independent of the action of the operator.
- The device combines the breaking and disconnection functions.
- The earthing switch placed in the SF6 has a short-circuit making capacity, in compliance with standards.
- Any accidental over-pressures are eliminated by the opening of the safety membrane, in which case the gas is directed toward the back of the unit, away from the operator.

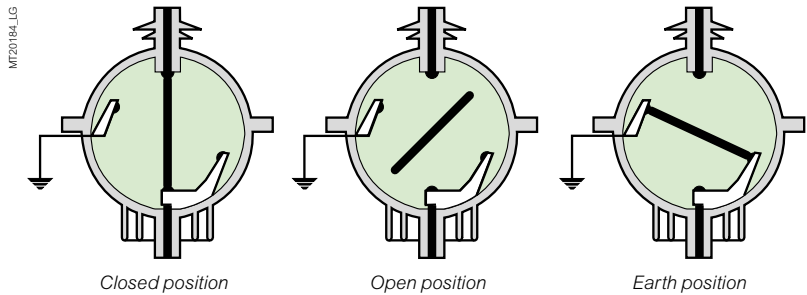

SF6 circuit breaker: SF1

Gas tightness

The SF1 circuit breaker is made up of three separate poles mounted on a structure supporting the operating mechanism. Each pole-unit houses the active elements in an insulating enclosure filled with gas to a relative pressure of 1.5 bar (0,15 mPa) for 630 A to 20 kA and 2 bar (0,2 mPa) for 1250 A and 630 A/25 kA. It satisfies "sealed pressure system" requirements and seal tightness is always checked in the factory.

Operating safety

Accidental over-pressures are eliminated by the opening of the safety membrane.

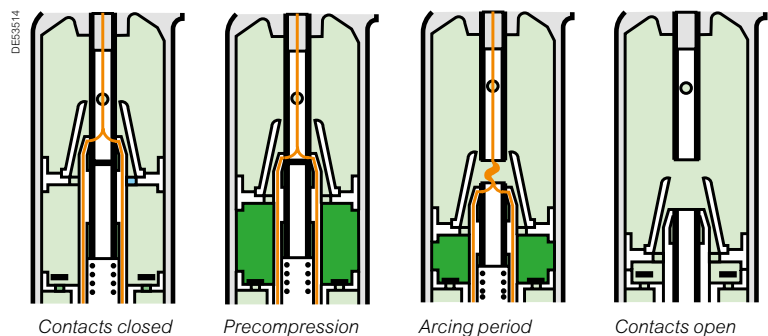

Safety of people

By switchgear

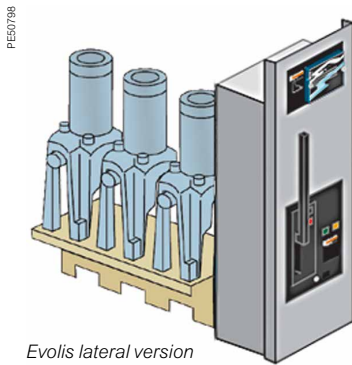
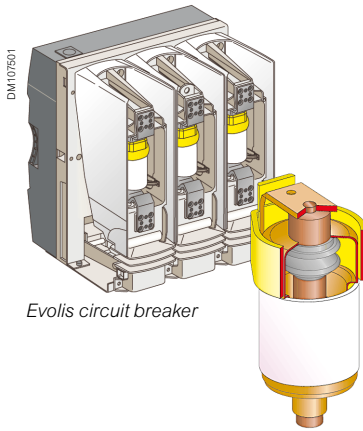

Vacuum type circuit breaker: Evolis

Vacuum tightness

The Evolis circuit breaker comprises three separate pole units fixed on a structure supporting the control mechanism. Each pole encloses all of the active parts in an insulating enclosure, under vacuum, and its vacuum tightness is systematically checked in the factory.

Operating safety

The magnetic field is applied along the contact axis of the vacuum type circuit breaker. This process diffuses the arc in a regular manner with high currents. It ensures optimum distribution of the energy along the compact surface so as to avoid local hot spots.

The advantages of this technique:

- A simplified vacuum type circuit breaker which is consequently very reliable,
- Low dissipation of arcing energy in the circuit breaker,
- Highly efficient contacts which do not distort during repeated breaking,
- Significant reduction in control energy.

Vacuum type contactor

Vacuum tightness

Vacuum contactor comprises three separate poles fixed on a structure supporting the control mechanism. Each pole encloses all of the active parts in an insulating enclosure under vacuum and its vacuum tightness is checked in the factory.

Safety of people

By operating mechanism safety



Visibility of main contacts

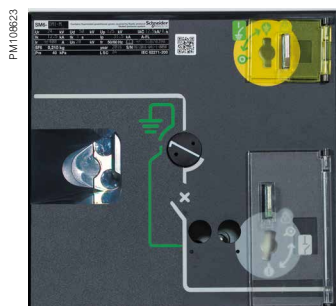

Voltage Presence Indicating System

VPIS complies with 62271-206 standard allowing to indicate the voltage presence on each phase with LEDs. Designed for severe environments so that to guarantee high reliability in MV/LV substations worldwide.

Exits in Voltage Output version to provide voltage presence information to VD23 voltage presence relay.



Reliable operating mechanism

Switchgear status indicator:

Fitted directly to the drive shaft, these give a definite indication of the contact's position. (appendix A of standard IEC 62271-102).

Operating lever:

This is designed with an anti-reflex device that stops any attempt to re-open the device immediately after closing the switch or the earthing disconnecter.

Locking device:

Between one and three padlocks enable the following to be locked:

- Access to the switching shaft of the switch or the circuit breaker,
- Access to the switching shaft of the earthing disconnecter,
- Operating of the opening release push-button.

Simple and effortless switching

Mechanical and electrical controls are side by side on the front fascia, on a panel including the schematic diagram indicating the device's status (closed, open, earthed):

- **Closed:** The drive shaft is operated via a quick acting mechanism, independent of the operator. No energy is stored in the switch, apart from when switching operations are taking place. For combined switch fuses, the opening mechanism is armed at the same time as the contacts are closed.
- **Opening:** the switch is opened using the same quick acting mechanism, operated in the opposite direction. For circuit breakers and the combined switch fuses, opening is controlled by:
 - a push-button
 - a fault.
- **Earthing:** a specific control shaft enables the opening or closing of the earthing contacts. Access to this shaft is blocked by a cover that can be slid back if the switch is open but which remains locked in place if it is closed.

Visibility of main contacts (option)

The position of main contacts is clearly visible from the front of the cubicle through the window.

Gas pressure indicator (option)

Despite SM6 switch is sealed pressure system and has open and close capacity on rated current at 0 bar relative pressure SF6, to insure you about the internal pressure, we propose on request before sale or on site by after-sales either a pressure switch or an analog manometer on the switch. These devices are both fitted without any alteration on the switch, they are temperature compensated and compatible with visibility of main contacts if requested.

Safety of people

By internal arc protection

Standard IEC 62271-200 appendix A indicates a method for testing switchgear in metal enclosures under internal arc conditions. The aim of this test is to show that an operator situated in front of a switchboard would be protected against the effects of an internal fault.

To enhance the safety of people, it is desirable to provide as high a degree of protection as possible by evacuating the effects of internal arc using:

- Evacuation systems which direct gases towards the top or the bottom of the switchboard enabling over pressure to be limited in the case of an internal fault in the compartments
- Channelling and evacuating hot gases towards an external area, which is not hazardous for the operator
- Materials which are non-inflammable in the cubicles
- Reinforced panels.

Consequently: The SM6 is designed to offer a good level of safety

Control of the architecture:

- Compartment type enclosure.

Technological control:

- Electrotechnical: modelling of electrical fields,
- Mechanical: parts produced using CAD systems.

Use of reliable components:

- choice of materials,
- earthing switch with closing capacity.

Devices for operating safety:

- Voltage presence indicator on the front face,
- Natural reliable interlocking,
- Locking using keys or padlocks.

SM6 internal arc (in conformity with IEC 62271-200 appendix A)

In all internal arc versions, the SM6 has successfully passed all of the type testing relative to standard IEC 62271-200 (5 acceptance criteria). The materials used meet the constraints for which the SM6 is designed. The thermal and mechanical forces that an internal arc can produce are perfectly absorbed by the enclosure. An operator situated in front of the SM6 switchboard during an internal fault will not be exposed to the effects of arcing.

Internal arc withstand (in conformity with IEC 62271-200)

3 versions are available for SM6-24	Basic	Advance
12.5 kA 1 s, IAC: A-FLR	●	●
16 kA 1 s, IAC: A-FL & IAC: A-FLR		●
20 kA 1 s, IAC: A-FL & IAC: A-FR		●

1 version is available for SM6-36

16 kA 1 s, IAC: A-FL

Safety of people

By internal arc protection

SM6 proposes several options to install a standard internal arc withstand switchboard

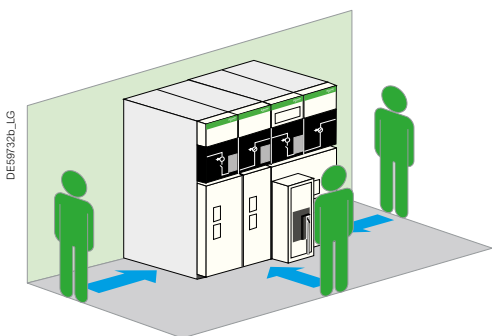

Example of installation of an SM6 switchboard installed against the wall downwards exhaust 12.5 kA 1 s and 16 kA 1 s, IAC: A-FL: 3-sides internal arc protection

3-sides internal arc protection IAC: A-FL

- 12,5 kA 1 s, 16 kA 1 s and 20 kA 1 s for SM6-24
- 16 kA 1 s for SM6-36

SM6 switchboard positioned against the wall, access to the rear of the cubicles is impossible, internal arc protection on three sides is sufficient.

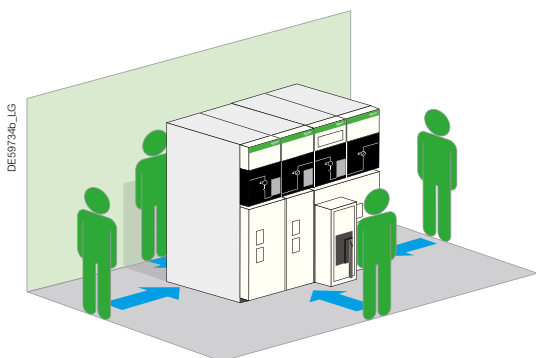

Example of installation of an SM6-24 switchboard installed in the middle of a room downwards exhaust 16 kA 1 s, IAC: A-FLR: 4-sides internal arc protection

4-sides internal arc protection IAC: A-FLR

- 2,5 kA 1 s, 16 kA 1 s and 20 kA 1 s for SM6-24

For SM6 switchboards installed in the middle of a room, 4-sides internal arc protection is necessary in order to protect an operator moving around the switchboard.

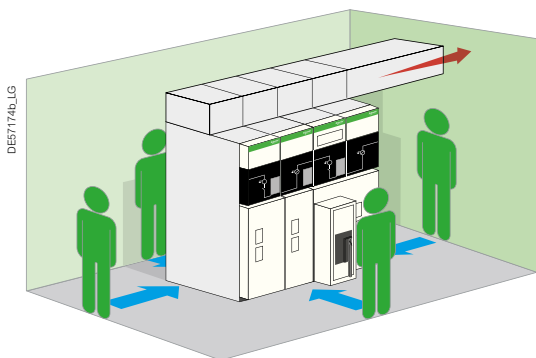

Example of installation of an SM6-24 switchboard installed in the middle of a room upwards exhaust 16 kA 1 s and 20 kA 1 s, IAC: A-FLR: 4-sides internal arc protection

Choice of exhaust (Installation requirements manual to be considered)

- Downwards exhaust
Civil engineering with an adequate volume is necessary.
- Upwards exhaust for SM6-24
A ceiling height greater or equal than 2150 mm is necessary, duct at the right or left side of the cubicle (not supplied).

Characteristics of the functional units

Characteristics of the functional units

Functional units selection	56
Switching	56
Protection	58
Metering	65
Other functions	66

Operating mechanisms	68
-----------------------------	-----------

Auxiliaries	72
--------------------	-----------

Current transformers for SM6-24	74
--	-----------

Current transformers for SM6-36	77
--	-----------

Voltage transformers for SM6-24	78
--	-----------

Voltage transformers for SM6-36	80
--	-----------

Motors protection units	81
--------------------------------	-----------

Protection of transformers	82
-----------------------------------	-----------

Interlocks	84
-------------------	-----------

Functional units selection

Switching

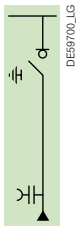
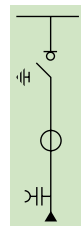
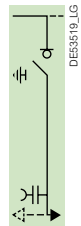
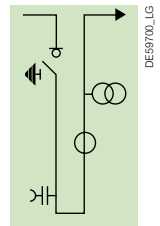
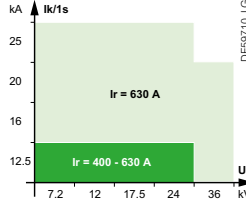
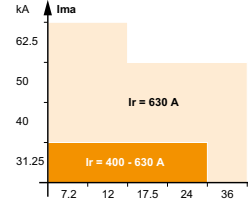
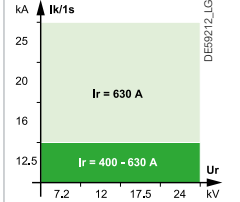
	IM Switch unit 	IMC Switch unit 	IMB Switch unit with earthing switch, right or left outgoing 	IMM Switch and measurement unit, right or left outgoing line 
Electrical characteristics				
Basic equipment				
Switch and earthing switch	•	•	•	•
Three-phase busbars	•	•	•	•
CIT operating mechanism	•	•	•	•
Voltage presence indicator	•	•	•	•
150 W heating element	For SM6-36	For SM6-36	For SM6-36	For SM6-36
LSC2A	•	•	•	•
Connection pads for dry-type cables	•	•		
Three-phase bottom busbars for outgoing lines			• (right or left)	• (right or left)
Current transformers		1 to 3 CTs, for SM6-24 / 3 CTs, for SM6-36		3 CTs
Version				
CI2 operating mechanism ⁽¹⁾	•	•	•	•
CI1 operating mechanism ⁽¹⁾	•	For SM6-36	•	•
Cubicle options				
Digital ammeter	•			
Surge arresters ⁽²⁾	•			
630 A busbars earthing switch cabinet ⁽³⁾	For SM6-24			
Ambient monitoring	•			
Earth fault indicators	•	•		
Connection pads for two dry-type single-core cables for 36 kV	•	•		
Motor for operating mechanism	•	•	•	
Motor with severe and communication	•	•	•	
Auxiliary contacts	•	•	•	
Key-type interlocks	•	•	•	
Release units (coil)	•	•	•	
Operation counter	•	•	•	
1250 A three-phase upper busbars	•	•	•	
630 A three-phase upper busbars for severe operating conditions	For SM6-24	For SM6-24	For SM6-24	
Visibility of main contacts	•	•	•	
Pressure indicator device	•	•	•	
Enlarged low-voltage control cabinet	For SM6-24	For SM6-24	For SM6-24	
50 W heating element	For SM6-24	For SM6-24	For SM6-24	
630 A cable connection by the top (no internal arc withstand if selected) protection using Sepam programmable electronic unit				•
Three voltage transformers				•
Key-type interlocks				•
Arc detection	•	•	•	•
Thermal monitoring	•	•	•	•

⁽¹⁾ IM / IMC: In 800 A version for SM6-24, please consult us / ⁽²⁾ For SM6-36 and for SM6-24 in 500 mm width cubicle / ⁽³⁾ Not available for internal arc IEC62271-200

Functional units selection

Switching

Automatic Transfer System for SM6-24

	<p>NSM-cables - Cables power supply for main incoming line (N) and standby line (S)</p> 	<p>NSM-busbars Cables power supply for main incoming line on left (N) and busbars for standby line (S) on right</p> 	<p>NSM-busbars Busbars power supply for main incoming line on left (N) and cables for standby line (S) on right</p> 
Electrical characteristics			
Basic equipment	<input checked="" type="checkbox"/>	<input checked="" type="checkbox"/>	<input checked="" type="checkbox"/>
Switch and earthing switch	<input checked="" type="checkbox"/>	<input checked="" type="checkbox"/>	<input checked="" type="checkbox"/>
Three-phase busbars	<input checked="" type="checkbox"/>	<input checked="" type="checkbox"/>	<input checked="" type="checkbox"/>
Voltage presence indicator	<input checked="" type="checkbox"/>	<input checked="" type="checkbox"/>	<input checked="" type="checkbox"/>
Connection pads for dry-type cables	<input checked="" type="checkbox"/>	<input checked="" type="checkbox"/>	<input checked="" type="checkbox"/>
LSC2A	<input checked="" type="checkbox"/>	<input checked="" type="checkbox"/>	<input checked="" type="checkbox"/>
Mechanical interlocking	<input checked="" type="checkbox"/>	<input checked="" type="checkbox"/>	<input checked="" type="checkbox"/>
Motorized operating mechanism CI2 with open/close coils	<input checked="" type="checkbox"/>	<input checked="" type="checkbox"/>	<input checked="" type="checkbox"/>
Additional enclosure	<input checked="" type="checkbox"/>	<input checked="" type="checkbox"/>	<input checked="" type="checkbox"/>
Automatic-control equipment (T200 S)	<input checked="" type="checkbox"/>	<input checked="" type="checkbox"/>	<input checked="" type="checkbox"/>
Cubicle options	<input checked="" type="checkbox"/>	<input checked="" type="checkbox"/>	<input checked="" type="checkbox"/>
Auxiliary contacts	<input checked="" type="checkbox"/>	<input checked="" type="checkbox"/>	<input checked="" type="checkbox"/>
Key-type interlocks	<input checked="" type="checkbox"/>	<input checked="" type="checkbox"/>	<input checked="" type="checkbox"/>
1250 A three-phase upper busbars	<input checked="" type="checkbox"/>	<input checked="" type="checkbox"/>	<input checked="" type="checkbox"/>
630 A three-phase upper busbars for severe operating conditions	<input checked="" type="checkbox"/>	<input checked="" type="checkbox"/>	<input checked="" type="checkbox"/>
Visibility of main contacts	<input checked="" type="checkbox"/>	<input checked="" type="checkbox"/>	<input checked="" type="checkbox"/>
Pressure indicator device	<input checked="" type="checkbox"/>	<input checked="" type="checkbox"/>	<input checked="" type="checkbox"/>
50 W heating element	<input checked="" type="checkbox"/>	<input checked="" type="checkbox"/>	<input checked="" type="checkbox"/>
Key-type interlocks	<input checked="" type="checkbox"/>	<input checked="" type="checkbox"/>	<input checked="" type="checkbox"/>

Functional units selection

Protection

Fuse-switch

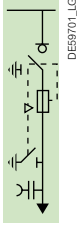
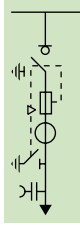
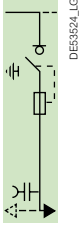
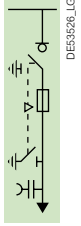
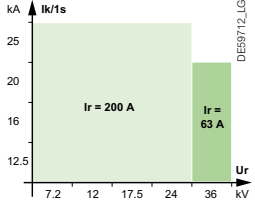
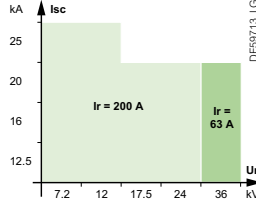
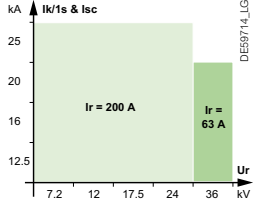
	QM Fuse-switch combination unit	QMC Fuse-switch combination unit	QMB Fuse-switch combination unit Outgoing line right or left	PM Fused-switch unit	
					
Electrical characteristics					
Basic equipment	Switch and earthing switch	•	•	•	
	Three-phase busbars	•	•	•	
	CIT operating mechanism	•	•	•	
	Voltage presence indicator	•	•	•	
	150 W heating element	For SM6-36	For SM6-36	For SM6-36	
	LSC2A	•	•	•	
	Connection pads for dry-type cables	•	•	•	
	Three-phase bottom busbars for outgoing lines			• (right or left)	
	Downstream earthing switch 2 kA rms making capacity			•	
	Equipment for three UTE (for SM6-24) or DIN striker fuses			•	
Current transformers		1 to 3 CTs, for SM6-24 / 3 CTs, for SM6-36			
Version					
Equipment for three UTE striker fuses	For SM6-24	For SM6-24	For SM6-24		
CI1 operating mechanism				•	
CI2 operating mechanism	•	For SM6-36	For SM6-36	For SM6-36	
Cubicle options	Digital ammeter	•	•	•	
	Motor for operating mechanism	•	•	•	
	Motor with severe and communication	•	•	•	
	Auxiliary contacts	•	•	•	
	Key-type interlocks	•	•	•	
	Auxiliary contact for blown fuses	•	•	•	
	Fuses	•	•	•	UTE (for SM6-24) or DIN striker fuses
	Mechanical indication system for blown fuses				•
	Release units (coil)	•	•	•	For SM6-36
	1250 A three-phase upper busbars	•	•	•	•
	630 A three-phase upper busbars for severe operating conditions	For SM6-24	For SM6-24	For SM6-24	For SM6-24
	Visibility of main contacts	•	•	•	•
	Pressure indicator device	•	•	•	•
	Enlarged low-voltage control cabinet	For SM6-24	For SM6-24	For SM6-24	For SM6-24
	50 W heating element	For SM6-24	For SM6-24	For SM6-24	For SM6-24
	630 A cable connection by the top (no internal arc withstand if selected)	•	•	•	•
	Key-type interlocks	•	•	•	•
Arc detection	•	•	•	•	
Ambient monitoring	•				
Thermal monitoring	•	•	•	•	

Functional units selection

Protection

SF6 type circuit breaker

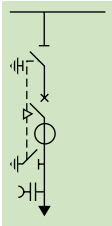
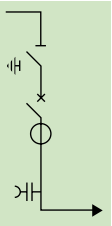
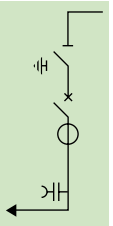
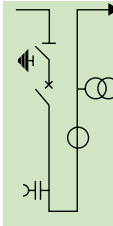
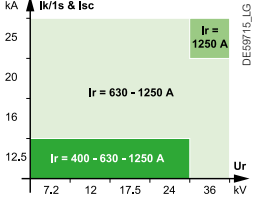
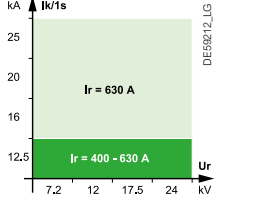
	DM1-A Single-isolation disconnectable CB 	DM1-D Single-isolation disconnectable CB. Outgoing line on right 	DM1-D Single-isolation disconnectable CB. Outgoing line on left 	DM1-M Single-isolation, disconnectable CB and measurement unit. Outgoing line on right 
Electrical characteristics				
Basic equipment				
SF1 disconnectable circuit breaker	•	•	•	•
Disconnecter and earthing switch	•	•	•	•
Three-phase busbars	•	•	•	•
Circuit breaker operating mechanism RI	•	•	•	•
Disconnecter operating mechanism CS	•	•	•	•
Voltage presence indicator	•	•	•	•
Current transformers	3 CTs	3 CTs	3 CTs	Please consult us
Auxiliary contacts on circuit breaker	•	•	•	•
Mechanical interlocking between circuit breaker and disconnecter	•	•	•	•
150 W heating element	For SM6-36	For SM6-36	For SM6-36	For SM6-36
LSC2A	•	•	•	•
Connection pads for dry-type cables	•	•	•	•
Downstream earthing switch 2 kA rms making capacity at 630 A and 25 kA rms making capacity at 1250 A	•			
Three-phase bottom busbars		•	•	
Equipment for three UTE (for SM6-24) or DIN striker fuses				•
Version				
LPCT	Only with Easergy Sepam series 20, 40, 60, 80			
SFset circuit breaker disconnectable (For 400-630 A performances)	For SM6-24	For SM6-24	For SM6-24	
Cubicle options				
Arc detection	•	•	•	•
Thermal monitoring	•	•	•	•
630 A busbars earthing switch cabinet (not available for internal arc IEC62271-200)	For SM6-24	For SM6-24		
Ambient monitoring	•	•	•	
Auxiliary contacts on the disconnecter	•	•	•	
Protection	• (Easergy Sepam & Easergy P3 relay programmable electronic units)			
Three voltage transformers	•	•	•	
Key-type interlocks	•	•	•	
Surge arresters	•	•	•	
1250 A three-phase upper busbars at Ir 630 A	•	•	•	
630 A cable connection by the top (no internal arc withstand if selected)	•	•	•	
630 A three-phase upper busbars for severe operating conditions for	For SM6-24	For SM6-24	For SM6-24	
Enlarged low-voltage control cabinet	For SM6-24	For SM6-24	For SM6-24	
50 W heating element	For SM6-24	For SM6-24	For SM6-24	
Connection pads for two dry-type single-core cables				For SM6-36

Functional units selection

Protection

SF6 type circuit breaker

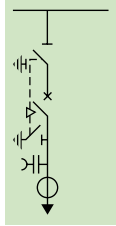
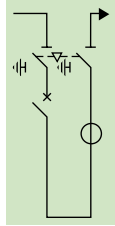
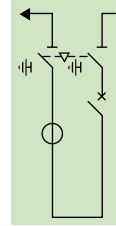
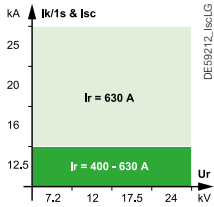
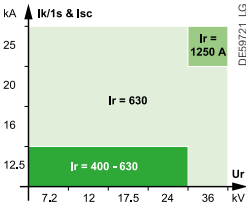
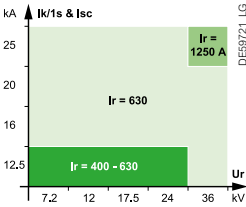
	DM1-S Single-isolation disconnectable CB unit with independent protection 	DM2 Double-isolation disconnectable CB unit Outgoing line on right 	DM2 Double-isolation disconnectable CB unit Outgoing line on left 
Electrical characteristics			
Basic equipment			
SF1 disconnectable circuit breaker	•	•	•
Disconnecter and earthing switch	•	•	•
Three-phase busbars	•	•	•
Circuit breaker operating mechanism RI	•	•	•
Disconnecter operating mechanism CS	•	•	•
Voltage presence indicator	•		
CTs		3	3
Auxiliary contacts on circuit breaker	•	•	•
Mechanical interlocking between circuit breaker and disconnecter	•	•	•
150 W heating element		For SM6-36	For SM6-36
LSC2A	•	•	•
Connection pads for dry-type cables	•		
Downstream earthing switch 2 kA rms making capacity at 630 A and 25 kA rms making capacity at 1250 A	•		
VIP relay	•		
Three CR sensors for VIP relay protection	•		
Options			
Cubicle			
Arc detection		•	
Thermal monitoring	•	•	•
630 A busbars earthing switch cabinet (not available for internal arc IEC62271-200)	For SM6-24	For SM6-24	
Ambient monitoring	•		
Auxiliary contacts on the disconnecter		•	•
Protection		Easergy Sepam & Easergy P3 relay programmable electronic units	
Voltage transformers		2 VTs phase-to-phase OR 3 VTs phase-to-earth	
Key-type interlocks	•	•	•
1250 A three-phase upper busbars at Ir 630 A	•	•	•
630 A cable connection by the top (no internal arc withstand if selected)	•	•	•
630 A three-phase upper busbars for severe operating conditions	For SM6-24	For SM6-24	For SM6-24
Enlarged low-voltage control cabinet	For SM6-24	For SM6-24	For SM6-24
50 W heating element	For SM6-24	For SM6-24	For SM6-24
Circuit breaker			
Motor for operating mechanism	•	•	•
Release units (coil)	•	•	•
Operation counter on manual operating mechanism	•	•	•

Functional units selection

Protection

SF6 type circuit breaker

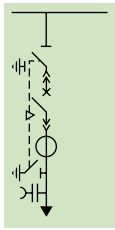
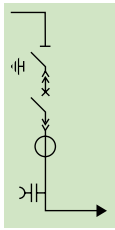
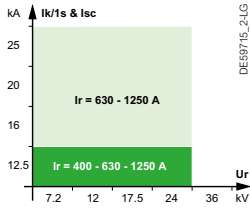
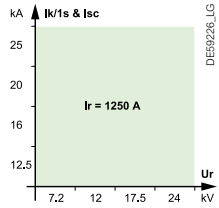
	DM1-W Withdrawable single-isolation CB unit	DM1-Z Withdrawable single-isolation CB unit. Outgoing line on right
		
Electrical characteristics		
Basic equipment		
SF1 withdrawable circuit breaker	●	●
Disconnector and earthing switch	●	●
Three-phase busbars	●	●
Circuit breaker operating mechanism RI	●	●
Disconnector operating mechanism CS	●	●
Voltage presence indicator	●	●
Current transformers	3 CTs	3 CTs
Auxiliary contacts on circuit breaker	●	●
Mechanical interlocking between circuit breaker and disconnector	●	●
LSC2A	●	●
Connection pads for dry-type cables	●	
Downstream earthing switch 25 kA rms making capacity	●	
Earthing switch operating mechanism CC	●	
Three-phase busbars		●
Version		
LPCT	Only with Easergy Sepam series 20, 40, 60 and 80	
Cubicle		
Auxiliary contacts on the disconnector	●	●
Protection	● (Easergy Sepam & Easergy P3 relay programmable electronic units)	
Key-type interlocks	●	●
Voltage transformers	3 VTs, for SM6-24	3 VTs, for SM6-24
Connection enclosure for cabling from above	For SM6-24	For SM6-24
50 W heating element for SM6-24	●	●
Enlarged low-voltage control cabinet	For SM6-24	For SM6-24
Thermal monitoring	●	●
Ambient monitoring (only for DM1W cubicle)	●	●
1250 A three-phase upper busbars at Ir 630 A	●	
630 A three-phase upper busbars for severe operating conditions	For SM6-24	
Surge arresters	Only for 630 A and SM6-24	
Circuit breaker		
Motor for operating mechanism	●	●
Release units (coil)	●	●
Operation counter on manual operating mechanism	●	●
Arc detection	●	●

Functional units selection

Protection

Vacuum type circuit breaker

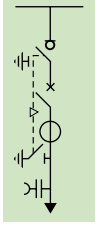
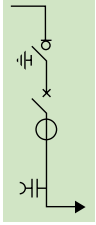
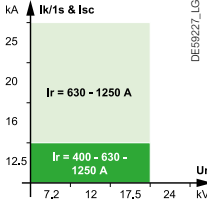
	<p>DMV-A Single-isolation circuit breaker unit</p>  <p>DE53841_LG</p>	<p>DMV-D Single-isolation circuit breaker unit Outgoing line on right</p>  <p>DE53842_LG</p>
<p>Electrical characteristics</p>  <p>DE56827_LG</p>		
<p>Basic equipment</p>		
<ul style="list-style-type: none"> • Evolis circuit breaker frontal • Switch and earthing switch for 400 - 630 A • Disconnecter and earthing switch for 1250 A • Three-phase busbars • Circuit breaker operating mechanism P2 • Disconnecter and switch operating mechanism CIT • Voltage presence indicator • Auxiliary contacts on circuit breaker • LSC2A • Current transformers • Easergy Sepam series 20 programmable electronic unit • Easergy P3 relay • Connection pads for dry-type cables • Downstream earthing switch 25 kA rms making capacity 	<ul style="list-style-type: none"> • 3 CTs 	<ul style="list-style-type: none"> • 3 CTs
<p>Options</p>		
<p>Cubicle</p> <ul style="list-style-type: none"> • Auxiliary contacts on the disconnecter • Voltage transformers • Key-type interlocks • 50 W heating element • 1250 A three-phase upper busbars at I_r 630 A • 630 A three-phase upper busbars for severe operating conditions • Enlarged low-voltage control cabinet • Thermal monitoring • Arc detection 	<ul style="list-style-type: none"> • 3, 	<ul style="list-style-type: none"> • 3,
<p>Circuit breaker</p> <ul style="list-style-type: none"> • Motor for operating mechanism • Release units (coil) • Operation counter on manual operating mechanism 		
<p>Other</p> <ul style="list-style-type: none"> • Easergy Sepam relays • Easergy P3 relay 		

Functional units selection

Protection

Vacuum type circuit breaker

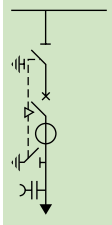
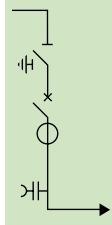
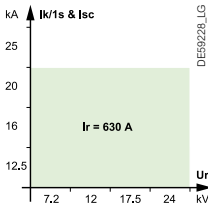
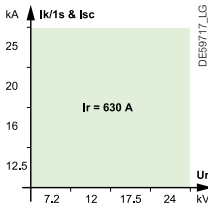
	DMVL-A Single-isolation disconnectable circuit breaker unit	DMVL-D Single-isolation disconnectable circuit breaker unit Outgoing line on right
		
Electrical characteristics		
Basic equipment	<ul style="list-style-type: none"> • Evolis circuit breaker lateral disconnectable • Disconnecter and earthing switch • Mechanical interlocking between circuit breaker and disconnecter • Three-phase busbars • Circuit breaker operating mechanism RI • Disconnecter operating mechanism CS • Voltage presence indicator • Auxiliary contacts on circuit breaker • Current transformers 3 CTs • Connection pads for dry-type cables • LSC2A • Downstream earthing switch 2 kA rms making capacity 	<ul style="list-style-type: none"> • Evolis circuit breaker lateral disconnectable • Disconnecter and earthing switch • Mechanical interlocking between circuit breaker and disconnecter • Three-phase busbars • Circuit breaker operating mechanism RI • Disconnecter operating mechanism CS • Voltage presence indicator • Auxiliary contacts on circuit breaker • Current transformers 3 CTs • Connection pads for dry-type cables • LSC2A
Options	Cubicle	
	<ul style="list-style-type: none"> • Auxiliary contacts on the disconnecter • Voltage transformers 3, • Key-type interlocks • 50 W heating element • 1250 A three-phase upper busbars at Ir 630 A • 630 A three-phase upper busbars for severe operating conditions • Enlarged low-voltage control cabinet • Easergy Sepam relays • Easergy P3 relay • Surge arresters • Thermal monitoring • Arc detection 	<ul style="list-style-type: none"> • Auxiliary contacts on the disconnecter • Voltage transformers 3, • Key-type interlocks • 50 W heating element • 1250 A three-phase upper busbars at Ir 630 A • 630 A three-phase upper busbars for severe operating conditions • Enlarged low-voltage control cabinet • Easergy Sepam relays • Easergy P3 relay • Surge arresters • Thermal monitoring • Arc detection
	Circuit breaker	
	<ul style="list-style-type: none"> • Motor for operating mechanism • Release units (coil) • Operation counter on manual operating mechanism 	<ul style="list-style-type: none"> • Motor for operating mechanism • Release units (coil) • Operation counter on manual operating mechanism

Functional units selection

Protection



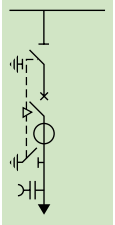
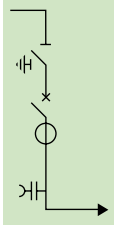
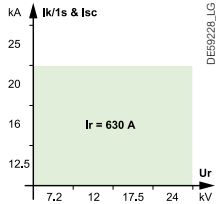
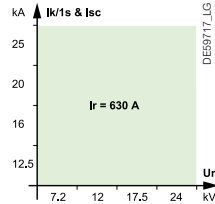

Contactor (Direct Motor Starter) for SM6-24

	DMVL-A Single-isolation disconnectable circuit breaker unit	DMVL-D Single-isolation disconnectable circuit breaker unit Outgoing line on right
		
Electrical characteristics		
Basic equipment		
Vacuum contactor	•	•
Disconnecter and earthing switch	•	•
Three-phase busbars	•	•
Contactor operating mechanism with magnetic holding or contactor with mechanical latching	•	•
Disconnecter operating mechanism CS	•	•
Current transformers	1 to 3 CTs	1 to 3 CTs
Auxiliary contacts on contactor	•	•
Connection pads for dry-type cables	•	•
Voltage presence indicator		
Downstream earthing switch 2 kA rms making capacity		
Operation counter on contactor		
Enlarged low-voltage control cabinet		
Mechanical interlocking between contactor and disconnector/earthing switch		
LSC2A		
Equipment for three DIN striker fuses		•
Mechanical indication system for blown fuses		•
Auxiliary contact for blown fuses		•
Version		
LPCT	Only with Easergy Sepam series 20, 40, 60, 80	
Options		
Cubicle		
Auxiliary contacts on the disconnector	•	•
Protection	Using Sepam programmable electronic unit	
Voltage transformers	1 to 3	1 to 3
Key-type interlocks	•	•
50 W heating element	•	•
1250 A three-phase upper busbars	•	•
630 A three-phase upper busbars for severe operating conditions	•	•
Thermal monitoring	•	•
Arc detection	•	•
Contactor		
Mechanical interlocking	•	•
DIN striker fuses		•

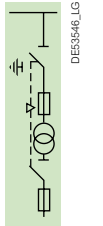
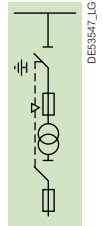
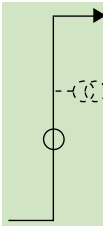
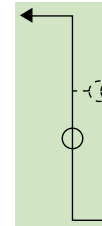
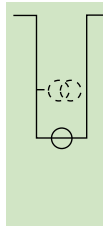
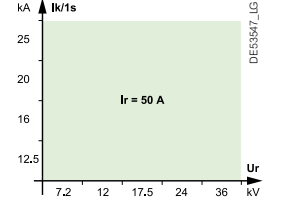
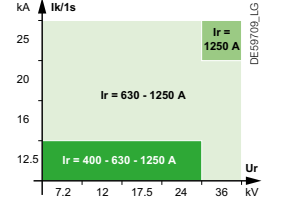
Functional units selection

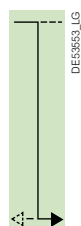

Metering

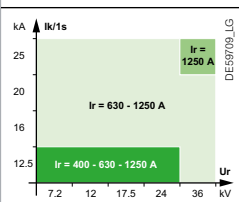
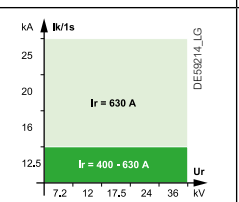
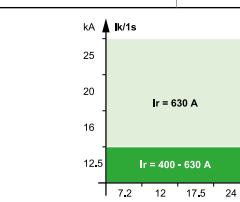
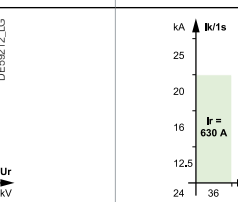
	CM Voltage transformers unit for network with earthed neutral system 	CM2 Voltage transformers unit for network with insulated neutral system 	GBC-A Current and/or voltage measurements unit Outgoing line on right 	GBC-A Current and/or voltage measurements unit Outgoing line on left 	GBC-B Current and/or voltage measurements unit 	
Electrical characteristics						
Basic equipment	Disconnecter and earthing switch	•	•			
	Three-phase busbars	•	•	•	•	•
	Operating mechanism CS	•	•			
	LV circuit isolation switch	•	•			
	LV fuses	•	•			
	6.3 A UTE or DIN type fuses	3	3			
	150 W heating element	For SM6-36	For SM6-36	For SM6-36	For SM6-36	For SM6-36
	LSC2A	•	•			
	LSC1			•	•	•
	Voltage transformers	3 VTs (phase-to-earth)	2 VTs (phase-to-phase)			
Current transformers			1 to 3 CTs for SM6-24 / 3 CTs for SM6-36	1 to 3 CTs for SM6-24 / 3 CTs for SM6-36	1 to 3 CTs for SM6-24 / 3 CTs for SM6-36	
Connection bars			•	•	•	
Options	Cubicle					
	Auxiliary contacts	•	•			
	Mechanical signalling for blown fuses	•	•			
	Auxiliary contact for blown fuses	1 to 3, for SM6-24	1 to 3, for SM6-24			
	1250 A three-phase upper busbars	•	•	For SM6-24	For SM6-24	For SM6-24
	630 A cable connection by the top (no internal arc withstand if selected)	•	•	For SM6-36	For SM6-36	
	50 W heating element	•	•	For SM6-24	For SM6-24	For SM6-24
	630 A three-phase upper busbars for severe operating conditions	For SM6-24	For SM6-24	For SM6-24	For SM6-24	For SM6-24
	Enlarged low-voltage control cabinet	For SM6-24	For SM6-24	For SM6-24	For SM6-24	For SM6-24
	Voltage transformers			3 VTs (phase-to-earth) / 2 VTs (phase-to-phase) for SM6-24		
Arc detection	•	•	•	•		

		Extension units				
		GBM	GIM	GEM	GUM	GMM
		Connection unit Outgoing line right or left	Intermediate bus unit	Extension unit VM6/SM6 -2	Extension unit Unifluorc/SM6 -24	Extension unit Modularc/SM6 -36
						
Electrical characteristics						
Basic equipment	Connection bars	•				
	Three-phase busbars for outgoing lines right or left	•		•	•	•
	150 W heating element for SM6-36	•				
	LSC1	•				
	Metallic envelop		•	•	•	•
Options	1250 A three-phase upper busbars at Ir 630 A	•	•			
	Enlarged low-voltage control cabinet	For SM6-24	For SM6-24			
	630 A cable connection by the top (no internal arc withstand if selected)	For SM6-36	For SM6-36			
	Arc detection	•	•			
	LV-continuity				•	•

Functional units selection

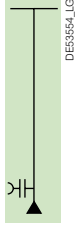
Other functions

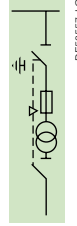
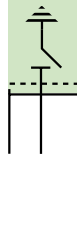
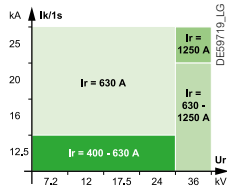
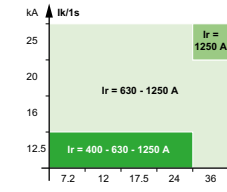
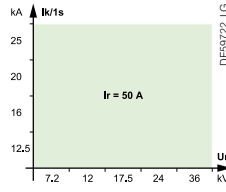
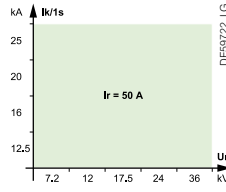
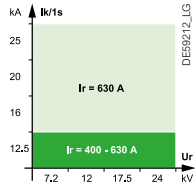
	GAM2 Incoming-cable-connection unit 	GAM Incoming-cable-connection unit 	SM Disconnector unit 	TM MV/LV transformer unit for auxiliaries 	EMB Busbars earthing switch enclosure 
Electrical characteristics					
Basic equipment	•	•	•	•	•
Three-phase busbars	•	•	•	•	•
Disconnector and earthing switch			•	•	Earthing switch
Voltage presence indicator	•	•	•		
Connection pads for dry-type cables	•	•	•		
Connection bars	•	•			• (Three-phases)
150 W heating element	For SM6-36	For SM6-36	For SM6-36	For SM6-36	
LSC1	•	•			
LSC2A			•		
Fuses for SM6-24				Two 6.3 A fuses, UTE or DIN type	
LV circuit isolating switch				•	
Voltage transformer				1 Phase-to-phase VT	
Downstream earthing switch 25 kA rms making capacity		•			
Operating mechanism CC		For SM6-24			
Operating mechanism CS		For SM6-36	•	•	
Operating mechanism CIT					•
Installation on 630 A IM 375 mm or DM1-A units (not available for internal arc IEC 62271-200)					Requires a key-type interlocks adapted to the switchboard network
Options	•	•			
Earth fault indicator	•	•			
Digital ammeter	•	•	For SM6-24		
1250 A three-phase upper busbars at Ir 630 A	•	•	•	•	
630 A three-phase upper busbars for severe operating conditions			For SM6-24	For SM6-24	
Enlarged low-voltage control cabinet	For SM6-24	For SM6-24	For SM6-24	For SM6-24	
630A cable connection by the top (no internal arc withstand if selected)	•	•	•	•	
50 W heating element	For SM6-24	For SM6-24	For SM6-24	For SM6-24	
Arc detection	•	•	•	•	
Thermal monitoring	•	•	•		
Surge arresters	For SM6-36	For SM6-24	For SM6-24	For SM6-36	
Auxiliary contacts		•	•	•	•
Auxiliary contact for blown fuses				For SM6-24	
Mechanical signalling for blown fuses				For SM6-24	
Ambient monitoring				For SM6-36	
Key-type interlocks		•	•	•	

The control devices required for the unit operating mechanisms are centralised on the front panel. The different types of operating mechanism are presented in the table opposite.

Operating speeds do not depend on the operator, except for the CS.

PM106524



Units	Type of operating mechanism						
	Switch/disconnector / downstream earthing switch					Circuit breaker	
	CIT	C11	C12	CS	CC	RI	P2
IM, IMB, IMM	●	○	○				
IMC	●	○	○				
PM	●	○	○ ⁽¹⁾				
QM		●	○				
QMC, QMB		●	○				
CM, CM2, CVM				●			
DM1-A, DM1-D, DM1-M, DM1-S, DM1-Z, DM2, DMVL-A, DMVL-D				●		●	
DM1-A ⁽²⁾ , DM1-W				●	●	●	
DMV-A, DMV-D	●						●
NSM-cables, NSM-busbars			●				
GAM 24 kV					●		
SM, TM, GAM 36 kV				●			
EMB	●						

● Provided as standard / ○ Other possibility / ⁽¹⁾ Only SM6-36 / ⁽²⁾ 1250 A version

Operating mechanism types	CIT		C11		C12			CS	
	Load-break switch	Fused switch	Load-break switch	Fuse switch combination	Load-break switch	Fuse switch combination	Disconnector		
Unit applications									
Main circuit switch	Closing	Opening	Closing	Opening	Mechanism charging	Closing	Opening	Closing	Opening
Manual operating mode	Hand lever	Hand lever	Hand lever	Push button	Hand lever	Push button	Push button	Hand lever	Hand lever
Electrical operating mode (option)	Motor	Motor	Motor	Coil	Motor	Coil	Coil	N/A	N/A
Speed of operation	1 to 2 s	1 to 2 s	4 to 7 s	35 ms	4 to 7 s	55 ms	35 ms	N/A	N/A
Network applications	Remote control network management		Remote control transformer protection		Remote control network management, need of quick reconfiguration (generator source, loop)			N/A	
Earthing switch	Closing	Opening	Closing	Opening	N/A	Closing	Opening	Closing	Opening
Manual operating mode	Hand lever	Hand lever	Hand lever	Hand lever	Hand lever	Hand lever	Hand lever	Hand lever	Hand lever

Double-function operating mechanism CIT

Switch function

- Independent-operation opening or closing by lever or motor

Earthing-switch function

- Independent-operation opening or closing by lever.
Operating energy is provided by a compressed spring which, when released, causes the contacts to open or close.

Auxiliary contacts

- Switch (2 O + 2 C)*
- Switch (2 O + 3 C) and earthing switch (1 O + 1 C)
- Switch (1 C) and earthing switch (1 O + 1 C) if motor option

Mechanical indications

- Fuses blown in unit PM

Motor option

- Motor severe environment and communication

(*) Included with the motor option

PM108625

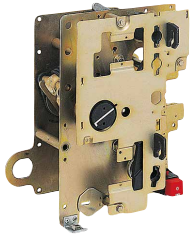

Double-function operating mechanism CI1

Switch function

- Independent-operation closing by lever or motor.
Operating energy is provided by a compressed spring which, when released, causes the contacts to open or close
- Independent-operation opening by push-button (O) or trip units

Earthing-switch function

- Independent-operation closing and opening by lever.
Operating energy is provided by a compressed spring which, when released, causes the contacts to open or close.

Auxiliary contacts

- Switch (2 O + 2 C) *
- Switch (2 O + 3 C) and earthing switch (1 O + 1 C)
- Switch (1 C) and earthing switch (1 O + 1 C) if motor option
- Fuses blown (1 C)

Mechanical indications

- Fuses blown in units QM

Opening releases

- Shunt trip

Motor option

- Standard or severe environment and communication

PM108626

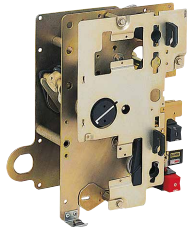

Double-function operating mechanism CI2

Switch function

- Independent-operation closing in two steps:
 - 1 - operating mechanism recharging by lever or motor
 - 2 - stored energy released by push-button (I) or trip unit
- Independent-operation opening by push-button (O) or trip unit

Earthing-switch function

- Independent-operation closing and opening by lever.
Operating energy is provided by a compressed spring which, when released, causes the contacts to open or close.

Auxiliary contacts

- Switch (2 O + 2 C) *
- Switch (2 O + 3 C) and earthing switch (1 O + 1 C)
- Switch (1 C) and earthing switch (1 O + 1 C) if motor option

Opening release shunt trip

Closing release shunt trip

Motor option

- Standard or severe environment and communication

(*) Included with the motor option.

PM109827

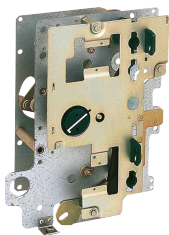

Double-function operating mechanism CS

Disconnecter and earth switch functions

- Dependent-operation opening and closing by lever.

Auxiliary contacts

- disconnector (2 O + 2 C) for units DM1-A, DM1-D, DM1-W, DM2, DMVL-A, DMVL-D, CVM,
- disconnector (2 O + 3 C) and earthing switch (1 O + 1 C) for units DM1-A, DM1-D, DM1-W, DM2, DMVL-A, DMVL-D, CVM,
- disconnector (1 O + 2 C) for units CM, CM2, TM, DM1-A, DM1-D, DM2, DMVL-A, DMVL-D, CVM.

Mechanical indications

- Fuses blown in units CM, CM2 and TM.

PM109828

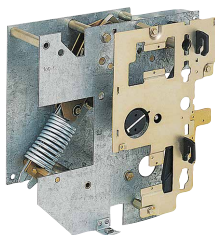

Single-function operating mechanism CC

Earthing switch function

- Independent-operation opening and closing by lever.
Operating energy is provided by a compressed spring which, when released, provokes opening or closing of the contacts.

Auxiliary contacts

- Earthing switch (1 O + 1 C).

FE57163



Single-function operating mechanism for the SF circuit breakers 24 kV and 36 kV, and Evolis 24 kV lateral

Circuit-breaker function

- Independent-operation closing in two steps.
First operating mechanism recharge by motor or lever, then release of the stored energy by push-button (I) or trip unit.
- Independent-operation opening by push-button (O) or trip units.

Auxiliary contacts

- Circuit breaker (4 O + 4 C)
- Mechanism charged (1 C)

Mechanical indications

- Operation counter

Opening releases

- Mitop (low energy)
- Shunt trip
- Undervoltage

Closing release

- shunt trip

Motor option

(option and installation at a later date possible).

Possible combinations between opening releases

Release type	SF1						SFset				
	Combinations						Combinations				
	1	2	3	4	5	6	1	2	3	4	
Mitop (low energy)	•	•	•				•	•	•		
Shunt trip		•		•	•			•			
Undervoltage			•		•	•					•

PM108629

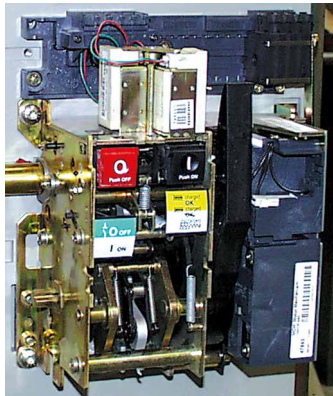

P2 stored energy operating mechanism for the Evolis circuit breaker 17.5 kV frontal

Circuit-breaker function

- Independent-switching operating closing in two steps.
First operating mechanism recharge by motor or lever, then release of the stored energy by push-button (I) or trip unit
- Independent-operation opening by push-button (O) or trip units
- Spring energy release

Auxiliary contacts

- circuit breaker (4 O + 4 C)
- mechanism charged (1 C)

Mechanical indications

- Operation counter

Opening releases

- Mitop (low energy)
- Shunt trip

Closing release

- Shunt trip

Motor option (option and installation at a later date possible).

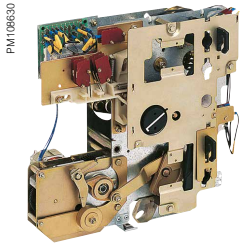

PM106330

Motor option and releases for switch-units

The operating mechanisms CIT, CI1 and CI2 may be motorised.

Un		DC					AC (50 Hz)*	
Power supply	(V)	24	48	110	125	220	120	230
Motor option								
	(W)	200						
	(VA)						200	
	Operating time for CIT	1 to 2 (s)					1 to 2 (s)	
	Charging time for CI1, CI2	4 to 7 (s)					4 to 7 (s)	
Opening releases								
Shunt trip	(W)	200	250	300	300	300		
	(VA)						400	750
	Response time (ms)	35					35	
Closing release								
Shunt trip	(W)	200	250	300	300	300		
	(VA)						400	750
	Response time (ms)	55					55	

* Please consult us for other frequencies.



PE57164

Motor option and releases for SF6 type circuit breakers and Evolis 24 kV lateral

Operating mechanism RI may be equipped with the motor option for the recharging function.

Un		DC					AC (50 Hz)*	
Power supply	(V)	24	48	110	125	220	120	230
Motor option								
	(W)	300						
	(VA)						380	
	Charging time (s)	15					15	
Opening times								
	Opening (ms)	<60						
	Breaking (ms)	<75						
	Closing (ms)	<100						

* Please consult us for other frequencies.

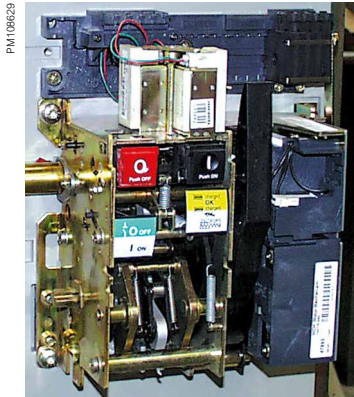

PM108629

Motor option and releases for Evolis circuit breakers 17.5 kV frontal

Charging motor and associated mechanism (P2)

Power supply	(Vac 50/60 Hz)	48/60	100/130	200/240
	(Vdc)	24/30	48/60	100/125
Threshold	0.85 to 1.1 Ur			
Consumption	(VA or W)	180		
Motor overcurrent	2 to 3 Ir during 0.1 s			
Charging time	6 s max.			
Switching rate	3 cycles per minute max.			
CH contact	10 A 240 V			

Opening times

Opening	(ms)	<60
Breaking	(ms)	<75
Closing	(ms)	<100



PE57842

Auxiliary contacts for vacuum contactor

The auxiliary contacts are of the changeover type with a common point.

The following are available:

- 3 NO + 3 NC for the electrically held version (option 3 NO & 3 NC additional auxiliary contacts)
- 5 NO + 6 NC for the mechanically latched version as standard

Characteristics

Operating voltage	Minimum	48 V
	Maximum	480 V
Rated current	10 A	
Breaking capacity	Vdc	60 W (L/R 150 ms)
	Vac	700 VA (power factor 0.35)

Open release characteristics

Power supply (Vdc)	48	125	250
Consumption (W)	470	680	640
Response time (ms)	20-40	20-41	20-40

Current transformers for SM6-24

Synthesis table by unit

		Units														
		QMC	CVM	DM1-A	DM1-D DMVL-D DM1M	DM1-W	DM2	GBC-A GBC-B	DMVL-A	DMV-A DMV-D	IMC	DM1-A DM1-D	DM1-W DM1-Z	GBC-A GBC-B	DMV-A DMV-D	
		630 A							1250 A							
TC	ARJP1	•	•													
	ARM3			•	•	•	•	•	•							
	ARJP2									•	•					
	ARJP3											•	•	•	•	
	CLP2				•											
	TLP130		•	•		•										
	ARM4			(*)												

(*) Please, consult us.

PEG0539



ARJP1

Transformer ARJP1/N2F

- Characteristics according to IEC standard 61869-2
- Single primary winding
- Double secondary winding for measurement and protection

Short-time withstand current I_{th} (kA)

I _{1n} (A)	10	20	30	50	75	100	150	200
I _{th} (kA)	1.2	2.4	3.6	6	10	10	10	10
t (s)	1							
Measurement	5 A	15 VA - class 0.5						
and protection	5 A	2.5 VA - 5P20						

PEG0539



ARJP1

Transformer ARJP1/N2F

- Characteristics according to IEC standard 61869-2
- Single primary winding
- Double secondary winding for measurement and protection

Short-time withstand current I_{th} (kA)

I _{1n} (A)	50	100	150	200
I _{th} (kA)	6	10		
t (s)	1			
Measurement	5 A	15 VA - class 0.5		
and protection	5 A	2.5 VA - 5P20		

Note: please consult us for other characteristics.

Current transformers for SM6-24



ARM3

Transformer ARM3/N2F

- Characteristics according to IEC standard 61869-2
- Double primary winding
- Single secondary winding for measurement and protection

Short-time withstand current I_{th} (kA)

I_n (A)	10/20	20/40	50/100	100/200	200/400	300/600
I_{th} (kA)	5	12.5	12.5/21*	12.5/25*	12.5/25*	25
t (s)	1					
Measurement and protection	7.5 VA - class 0.5					
1 A	1 VA - 10P30					
5 A	5 VA - 5P10		5 VA - 5P15			

* For 5 A protection

- Characteristics according to IEC standard 61869-2
- Double primary winding
- Double secondary winding for measurement and protection

Short-time withstand current I_{th} (kA)

I_n (A)	50/100		100/200	200/400	300/600
I_{th} (kA)	14.5		25	25	25
t (s)	1				
Measurement and protection	5 A	30 VA - class 0.5			
5 A	5 VA - 5P15	7.5 VA - 5P15			
5 A	7.5 VA - 5P10	15 VA - 5P10			



ARM4

Transformer ARM4

- Characteristics according to IEC standard 61869-2
- Single or double primary winding
- Up to 3 secondary windings (for measure and/or for protection)
- Rated highest voltage 7,2 - 12 - 17,5 - 24kV
- Rated primary current up to 630A (for SM6 cubicles)
- Secondary currents 5A or 1A
- Version with one secondary winding: ARM4/N1F
- Version with two secondary windings: ARM4/N2F
- Version with three secondary windings: ARM4/N3F (*)

(*) Please, consult us.



ARJP2

Transformer ARJP2/N2F

- Characteristics according to IEC standard 61869-2
- Single primary winding
- Double secondary winding for measurement and protection.

Short-time withstand current I_{th} (kA)

I_n (A)	50	100	200	400	600
I_{th} (kA)	25				
t (s)	1				
Measurement and protection	5 A	10 VA class 0.5	15 VA class 0.5	15 VA class 0.5	20 VA class 0.5
5 A	2.5 VA 5P20	2.5 VA 5P20	5 VA 5P20	5 VA 5P20	7.5 VA 5P20

(*) Consult us

Current transformers for SM6-24

PE6037



ARJP3

Transformer ARJP3/N2F

- Characteristics according to IEC standard 61869-2
- Single primary winding
- Double secondary winding for measurement and protection.

Short-time withstand current I_{th} (kA)

I_n (A)	1000	1250
I_{th} (kA)	25	
t (s)	1	
Measurement and protection	1 A	30 VA - class 0.5
	1 A	10 VA - 5P20
Measurement and protection	5 A	30 VA - class 0.5
	5 A	10 VA - 5P20

PE5661



Low Power Current Transformer (LPCT) CLP2

- Characteristics according to IEC standard 60044-8
- Large primary current range
- Direct output voltage for measurement and protection
- RJ45-8 pts secondary connector
- Insulation level 24 kV.

Minimum rated primary current	5 A
Rated nominal primary current	100 A
Rated extended primary current	1250 A
Rated nominal secondary output	22.5 mV
Accuracy class for measurement	0.5
Accuracy class for protection	5P
Accuracy limit factor	400
Rated short time thermal current	40 kA 1 s
Highest voltage (U_m)	24 kV
Rated power-frequency withstand	50 kV

PE57162



LPCT

Low Power Current Transformer (LPCT) TLP130

- Characteristics according to IEC standard 60044-8
- Large primary current range
- Direct output voltage for measurement and protection
- RJ45-8 pts secondary connector
- Insulation level 0.72 kV
- Internal diameter 130 mm.

Minimum rated primary current	5 A
Rated nominal primary current	100 A
Rated extended primary current	1250 A
Rated nominal secondary output	22.5 mV
Accuracy class for measurement	0.5
Accuracy class for protection	5P
Accuracy limit factor	250
Rated short time thermal current	25 kA 1 s
Highest voltage (U_m)	0.72 kV
Rated power-frequency withstand	3 kV

Current transformers for SM6-36



Current transformer ARM6T

Transformer ARM6T/N1 or N2

For DM1-A, DM1-D, SM6-36, DM2, IMC, GBC-A, and GBC-B units

- Characteristics according to IEC standard 61869-2
- Double primary winding
- Double secondary winding for measurement and protection.

Short-time withstand current I_{th} (kA)

I _{1n} (A)	50-100	75-150	100-200	150-300	200-400	300/600	1000/1250
I _{th} (kA)	16 - 20						25
t (s)	1						1
Measurement and protection	5 A	7.5 VA - 15 VA - class 0.5					30 VA - class 0.5
	5 A	2.5 VA - 5 VA - 5P20					10 VA - 5P20



Current transformer ARM9T

Transformer ARM9T

For DM1-A, DM1-D, and DM2 units

- Characteristics according to IEC standard 61869-2
- Double primary winding
- Double secondary winding for measurement and protection.

Short-time withstand current I_{th} (kA)

I _{1n} (A)	1000/1250	
I _{th} (kA)	40	
t (s)	1	
Measurement and protection	5 A	30 VA - class 0.5 - F _s < 10
	5 A	10 VA - 5P20



LPCT

Transformer TLP 130, TLP 190

Low Power Current Transformer (LPCT) for DM1-A units, SM6-36

- Characteristics according to IEC standard 60044-8
- Large primary current range
- Direct output voltage for measurement and protection
- RJ45-8 pts secondary connector
- Insulation level 0.72 kV
- Internal diameter 130 or 190 mm
- In SM6-36, TLP 130 can be used for 630 A, TLP 190 can be used up to 1250 A.

	TLP 130	TLP 190
Minimum rated primary current	5 A	5 A
Rated extended primary current	1250 A	2500 A
Secondary output	22.5 mV - 100 A	22.5 mV - 100 A
Accuracy class for measurement	0.5	0.5
Accuracy class for protection	5P	5P
Accuracy limit factor	250	400
Rated short time thermal current	25 kA 1 s	40 kA 1 s
Highest voltage (U _m)	0.72 kV	0.72 kV
Rated power-frequency withstand	3 kV	3 kV

Voltage transformers for SM6-24

Synthesis table by unit

		Units												
		CM	CVM	DM1-A	DM1-D DMVL-D	DM1-W	DM2	GBC-A DM1M	GBC-B	DMVL-A	DMV-A	DMV-D	CM2	TM
TC	VRQ2-n/S1	•		•	•	•	•	•	•	•				
	VRFR-n/S1		•							•		•		
	VRC2/S1							•	•			•		
	VRM3-n/S2							•	•					
	VCT24												•	
	VRC1/S1		•											

PE60526



VRQ2

Transformer VRQ2n/S1 (phase-to-earth) 50 or 60 Hz

- Characteristics according to IEC standard 61869-3.

Rated voltage (kV)	24			
Primary voltage (kV)	$10/\sqrt{3}$	$15/\sqrt{3}$	$15-20/\sqrt{3}$	$20/\sqrt{3}$
Secondary voltage (V)	100/ $\sqrt{3}$			
Thermal power (VA)	250			
Accuracy class	0.5			
Rated output for single primary winding (VA)	30	30		30
Rated output for double primary winding (VA)			30-50	

Transformer VRFR-n/S1 (phase-to-earth) 50 or 60 Hz

- Characteristics according to IEC standard 61869-3.

Rated voltage (kV)	17.5	
Primary voltage (kV)	$10/\sqrt{3}$	$15/\sqrt{3}$
Secondary voltage (V)	100/ $\sqrt{3}$	
Thermal power (VA)	250	
Accuracy class	0.5	
Rated output for single primary winding (VA)	30	

PE60527



VRC2

Transformer VRC2/S1 (phase-to-phase) 50 or 60 Hz

- Characteristics according to IEC standard 61869-3.

Rated voltage (kV)	24		
Primary voltage (kV)	10	15	20
Secondary voltage (V)	100		
Thermal power (VA)	500		
Accuracy class	0.5		
Rated output for single primary winding (VA)	50		

Voltage transformers for SM6-24



PE55848

Transformer VRM3-n/S2 (phase-to-earth and protected by fuses 0.3 A) 50 or 60 Hz

- Characteristics according to IEC standard 61869-3.

	Rated voltage (kV)	12	17.5	24
	Primary voltage (kV)	$10/\sqrt{3}$	$15/\sqrt{3}$	$20/\sqrt{3}$
	Secondary voltage (V)	100/ $\sqrt{3}$ - 100/3		
First secondary	Thermal power (VA)	200		
	Accuracy class	0.5		
	Rated output for single primary (VA)	30-50		
Second secondary	Thermal power (VA)	100		
	Accuracy class	3P		
	Rated output	50		



PE60628

Transformer VRC1/S1 (phase-to-phase) 50 or 60 Hz

- Characteristics according to IEC standard 61869-3.

Rated voltage (kV)	7.2				
Primary voltage (kV)	3.3	5	5.5	6	6.6
Secondary voltage (V)	110	100	110	100	110
Thermal power (VA)	300				
Accuracy class	0.5				
Rated output for single primary winding (VA)	100				

VRC1

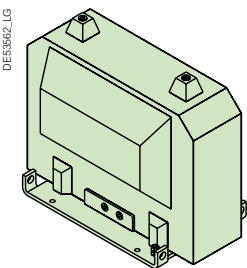

DES3862_LG

Transformer VCT24 (phase-to-phase) 50 or 60 Hz

Rated voltage (kV)	24			
Primary voltage (kV)	10	15	20	
Secondary voltage (V)	220			
Output (VA)	2500	2500	2500	
		4000	4000	

Note: the above mentioned voltage transformers are grounded neutral.
For other characteristics, please consult us.

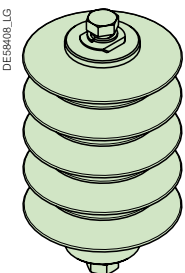

DES9408_LG

Surge arresters

For units IM500, DM1-A, DM1-W, GAM, DMV-A*, DMVL-A

In (A)	400/630			
Un (kV)	7.2	10	12	17.5
				24

Note: the rated voltage of the surge arrester is according to unit's rated voltage.
(*) limited up to 17.5 kV for DMV-A circuit breaker cubicles.

Voltage transformers for SM6-36

PEE7223



Voltage transformer VRF3

Transformer VRF3n/S2 (phase-to-earth)

For CM, GBC-A and GBC-B units

- Single primary winding
- Single secondary
- Characteristics according to IEC standard 61869-3

Rated voltage (kV)	36	
Primary voltage (kV)	$30\sqrt{3}$	$33\sqrt{3}$
Secondary voltage (V)	$100\sqrt{3}$	$100\sqrt{3}$ or $110\sqrt{3}$
Thermal power (VA)	450	
Accuracy class	0.5	3P
Rated output for single primary winding (VA)	30-50	30

PEE7224



Voltage transformer VRC3

Transformer VRC3/S1 (phase-to-phase)

- Single primary winding
- Single secondary
- Characteristics according to IEC standard 61869-3

	For CM2 units		For TM units
Rated voltage (kV)	36		36
Primary voltage (kV)	30	33	30
Secondary voltage (V)	100	100 or 110	220
Thermal power (VA)	700		1000
Accuracy class	0.5		
Rated output for single primary winding (VA)	50-100		

DSE6408_LG

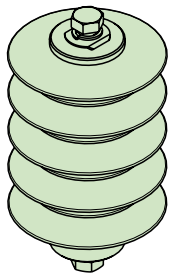

Surge arresters

For units IM, DM1-A, SM, GAM2

In (A)	630
Un (kV)	36

The current rating of fuses installed in units depends on:

- Motor current rating I_n
- Starting current I_d
- Frequency of starts.

The fuses rating is calculated such that a current equal to twice the starting current does not blow the fuse within period equal to the starting time. The adjacent table indicated the ratings which should be used, based on the following assumptions:

- direct on-line startup
 - $I_d/I_n \leq 6$
 - $pf = 0.8$ ($P \leq 500$ kW) or 0.9 ($P > 500$ kW)
 - $\eta = 0.9$ ($P \leq 500$ kW) or 0.94 ($P > 500$ kW).
- The indicated values are for Fusarc fuses (to DIN standard 43-625).

Example:

Consider a 950 kW motor at 5 kV.

$$I_n = \frac{P}{\sqrt{3} \cdot U \cdot \eta \cdot pf} = 130 \text{ A}$$

$$I_d = 6 \times I_n = 780 \text{ A}$$

Then select the next higher value, i.e. 790 A.

For six 5-second starts per hour, select fuses rated 200 A.

Note: the same motor could not be protected for 12 starts per hour since the maximum service voltage for the required 250 A rated fuses is 3.3 kV.

Selection of fuses for CVM units

Service voltage (kV)	$I_d = 6 \times I_e$	I_e	Starting time (s)					
	Starting current (A)	Rated operational current (continuous duty) (A)	250		200		160	
3.3	1100	183	250	250	250			
	942	157	250	250	250	250	250	250
	785	131	200	200	200	200	200	250
6.6	628	105	160	160	160	200	200	200
	565	94	160	160	160	160	160	160
	502	84	125	160	160	160	160	160
	439	73	125	125	125	160	160	160
	377	63	100	125	100	125	125	160
	314	52	100	100	100	100	100	125
	251	42	100	100	100	100	100	100
	188	31	80	100	100	100	100	100
	126	21	50	50	63	80	80	80
			5	10	30			
			Number of starts per hour					

Fuse selection method:

- if $I_d \geq 6 \times I_e$, use I_d to select the fuses
- if $I_d < 6 \times I_e$, use I_e to select the fuses.

Note:

Fuses are 292 mm long (Fusarc fuses).

Fuses are only for short circuit protection. For 250 A fuses, it is necessary to delay the opening of the contactor.

PE57161



Fuse ratings for SM6 protection units such as PM, QM, QMB and QMC depend, among other things, on the following criteria:

- Service voltage
- Transformer rating
- Fuse technology (manufacturer)

Different types of fuses with medium loaded striker may be installed:

- Solefuse fuses as per standard UTE NCF 64.210
- Fusarc CF fuses as per IEC 60.282.1 recommendation and dimensions are related to DIN 43.625 standard.

For fuse-switch combination unit type QM, QMB, QMC, refer only to the selection table and reference list of fuses. For all other type of fuses, consult us.

Example: for the protection of a 400 kVA transformer at 10 kV, select either Solefuse fuses rated 43 A or Fusarc CF fuses rated 50 A.

Fuse selection table

The color code is linked to the rated voltage of the fuse

Rating in A - no overload at $-5^{\circ}\text{C} < t < 40^{\circ}\text{C}$, ≤ 1000 m altitude.

Type of fuse Service voltage (kV)	Transformer rating (kVA)															Rated voltage (kV)	
	25	50	100	125	160	200	250	315	400	500	630	800	1000	1250	1600		2000
Solefuse (UTE NFC standards 13.100. 64.210)																	
5.5	6.3	16	31.5	31.5	63	63	63	63	63								
10	6.3	6.3	16	16	31.5	31.5	31.5	63	63	63	63						7.2
15	6.3	6.3	16	16	16	16	16	43	43	43	43	43	63				24
20	6.3	6.3	6.3	6.3	16	16	16	16	43	43	43	43	43	63			24
Solefuse (general case, UTE NFC standard 13.200)																	
3.3	16	16	31.5	31.5	31.5	63	63	100	100								
5.5	6.3	16	16	31.5	31.5	63	63	63	80	80	100	125					7.2
6.6	6.3	16	16	16	31.5	31.5	43	43	63	80	100	125	125				
10	6.3	6.3	16	16	16	31.5	31.5	31.5	43	43	63	80	80	100			12
13.8	6.3	6.3	6.3	16	16	16	16	16	31.5	31.5	31.5	43	63	63	80		17.5
15	6.3	6.3	16	16	16	16	16	16	31.5	31.5	31.5	43	43	63	80		24
20	6.3	6.3	6.3	6.3	16	16	16	16	31.5	31.5	31.5	43	43	63			24
22	6.3	6.3	6.3	6.3	16	16	16	16	16	31.5	31.5	31.5	43	43	63		24
Fusarc CF and SIBA⁽¹⁾ (general case for QM, QMB and QMC cubicle according to IEC 62271-105)																	
3.3	16	25	40	50	50	80	80	100	125	125	160 ⁽¹⁾	200 ⁽¹⁾					
5	10	16	31.5	40	40	50	63	80	80	125	125	160 ⁽¹⁾					
5.5	10	16	31.5	31.5	40	50	50	63	80	100	125	125	160 ⁽¹⁾	160 ⁽¹⁾			7.2
6	10	16	25	31.5	40	50	50	63	80	80	125	125	160 ⁽¹⁾	160 ⁽¹⁾			
6.6	10	16	25	31.5	40	50	50	63	80	80	100	125	125	160 ⁽¹⁾			
10	6.3	10	16	20	25	31.5	40	50	50	63	80	80	100	100	125 ⁽¹⁾	200 ⁽¹⁾	12
11	6.3	10	16	20	25	25	31.5	40	50	50	63	80	100	100	125 ⁽¹⁾	160 ⁽¹⁾	17.5
13.8	6.3	10	16	16	20	25	31.5	31.5	40	50	50	63	80	80	100 ⁽¹⁾	125 ⁽¹⁾	125 ⁽¹⁾
15	6.3	10	10	16	16	20	25	31.5	40	50	50	63	80	80	100 ⁽¹⁾	125 ⁽¹⁾	125 ⁽¹⁾
20	6.3	6.3	10	10	16	16	25	25	31.5	40	40	50	50	63	80	100 ⁽¹⁾	125 ⁽¹⁾
22	6.3	6.3	10	10	10	16	20	25	25	31.5	40	40	50	50	80	80	100 ⁽¹⁾
Fusarc CF for dry type transformers⁽²⁾																	
30					10			10	16	20	25	31.5	31.5	50	50	63	63
31.5					10			10	16	20	25	25	31.5	50	50	63	63
33					6.3			10	16	20	25	25	31.5	40	50	50	63
34.5					6.3			10	16	20	25	25	31.5	40	50	50	63
Fusarc CF oil immersed type transformers⁽²⁾																	
30					10			10	16	20	25	31.5	31.5	40	40	50	63
31.5					10			10	16	20	25	31.5	31.5	40	40	50	63
33					10			10	16	20	25	25	31.5	31.5	40	40	50
34.5					10			10	16	20	25	25	31.5	31.5	40	40	50

(1) SIBA fuses

(2) This selection table has been prepared according to the technical characteristics of France Transfo. The characteristics of transformers and fuses may change according to manufactures and standards.

⚠ Please consult us for overloads and operation over 40°C for France Transfo oil immersed type transformers.

Protection of transformers

Transformer protection by fuse-switches

Fuses dimensions

Solefuse (UTE standards)		Dimensions		
Ur (kV)	Ir (A)	L (mm)	Ø (mm)	Weight (kg)
7.2	6.3 to 125	450	55	2
12	100	450	55	2
17.5	80	450	55	2
24	6.3 to 63	450	55	2

Fusarc CF (DIN standards)		Dimensions			
Ur (kV)	Ir (A)	L (mm)	Ø (mm)	Weight (kg)	
7.2	125	292	86	3.3	
	6.3	292	50.5	1.2	
	10	292	50.5	1.2	
	16	292	50.5	1.2	
	20	292	50.5	1.2	
	25	292	57	1.5	
	12	31.5	292	57	1.5
		40	292	57	1.5
		50	292	78.5	2.8
		63	292	78.5	2.8
80		292	78.5	2.8	
24	6.3	442	50.5	1.6	
	10	442	50.5	1.6	
	16	442	50.5	1.6	
	20	442	50.5	1.6	
	25	442	57	2.2	
	31.5	442	57	2.2	
	40	442	57	2.2	
	50	442	78.5	4.1	
	63	442	78.5	4.1	
	80	442	86	5.3	
36	10	537	50.5	1.8	
	16	537	50.5	1.8	
	25	537	57	2.6	
	31.5	537	78.5	4.7	
	40	537	78.5	4.7	
	50	537	86	6.4	
	63	537	86	6.4	

SIBA		Dimensions		
Ur (kV)	Ir (A)	L (mm)	Ø (mm)	Weight (kg)
7.2	160	292	85	3.8
	200	292	85	5.4
	125	292	67	2
12	160	292	85	3.8
	200	292	85	3.8
17.5	125	442	85	5.4
	100	442	85	5.4
24	125	442	85	5.4

Switch units

- **The switch can be closed** only if the earthing switch is open and the access panel is in position.
- **The earthing switch can be closed** only if the switch is open.
- **The access panel for connections can be opened** only if the earthing switch is closed.
- **The switch is locked** in the open position when the access panel is removed. The earthing switch may be operated for tests.

Circuit-breaker units

- **The disconnecter(s) can be closed** only if the circuit breaker is open and the front panel is locked (interlock type 50).
- **The earth switch(es) can be closed** only if the disconnecter(s) is/are open.
- **The access panel for connections can be opened** only if:
 - the circuit breaker is locked open,
 - the disconnecter(s) is/are open,
 - the earth switch(es) is/are closed.

Note: it is possible to lock the disconnecter(s) in the open position for no-load operations with the circuit breaker.

Functional interlocks

These comply with IEC recommendation 62271-200 and EDF specification HN 64-S-41 (for 24 kV).

In addition to the functional interlocks, each disconnecter and switch include:

- **built-in padlocking** capacities (padlocks not supplied)
- **four knock-outs** that may be used for keylocks (supplied on request) for mechanism locking functions.

Units	Interlock											
	A1	C1	C4	A3	A4	A5	50	52	P1	P2	P3	P5
IM, IMB, IMC, IMM				●	●				●			
PM, QM, QMB, QMC,	●	●	●									
DM1-A, DM1-D, DM1-W, DM1-Z, DM1-S, DMV-A, DMV-D, DMVL-A, DMVL-D	●	●	●				●					
CVM		●						●				
NSM				●					●			
GAM				●		●						●
SM										●	●	
DM2							●					
DM1-M							●					
DM1-M							●					

Key-type interlocks

Functional interlocks

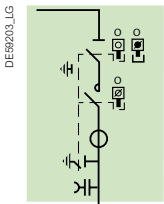
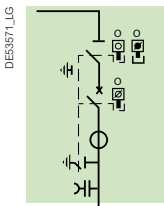

50 type Prevents

- on-load switching of the disconnectors.

Allows

- off-load operation of the circuit breaker with the disconnectors open (double isolation).
- off-load operation of the circuit breaker with the disconnecter open (single isolation).

52 type Prevents

- on-load switching of the disconnectors.

Allows

- off-load operation of the contactor with the disconnectors open (double isolation).
- off-load operation of the contactor with the disconnecter open (single isolation).

Legend for key-type interlocks:

MT2024QEN

○ □ No key

□ Key released

■ Key captive

— Panel or door

Outgoing units

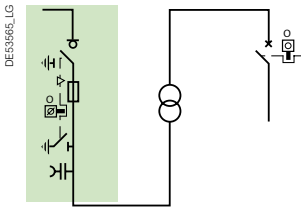

- A1 type**
- To prevent closing of the earthing switch on a transformer protection unit unless the LV circuit breaker is locked in the "open" or "disconnected" position

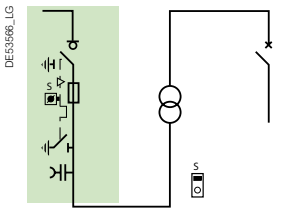

- C1 type**
- To prevent access to the transformer if the earthing switch for transformer protection has not first been closed

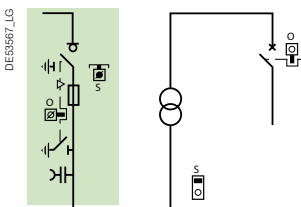

- C4 type**
- To prevent closing of the earthing switch on a transformer protection unit unless the LV circuit breaker is locked in the "open" or "disconnected" position
 - To prevent access to the transformer if the earthing switch for transformer protection has not first been closed

Ring units

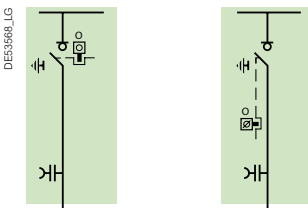

- A3 type**
- To prevent closing of the earthing switch on a load-side cubicle unless the line-side switch is locked "open"

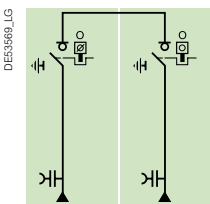

- A4 type**
- To prevent the simultaneous closing of two switches.

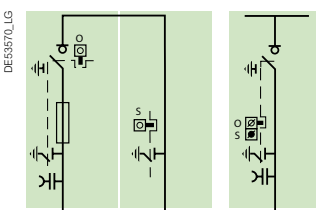

- A5 type**
- To prevent closing of the earthing switch on the casing unit unless the downstream and upstream switches are locked in the "open" position

Legend for key-type interlocks:

MT20240EN

No key

Key released

Key captive

Panel or door

Ring units

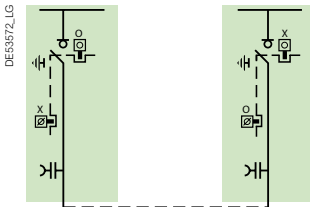

- P1 type**
- to prevent the closing of an earthing switch if the switch of the other unit has not been locked in the "open" position.

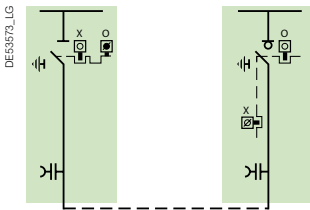

- P2 type**
- to prevent on-load operation of the disconnector unless the switch is locked "open"
 - to prevent the closing of the earthing switches unless the disconnector and the switch are locked "open".

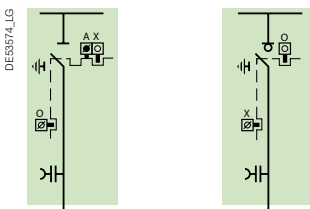

- P3 type**
- to prevent on-load operation of the disconnector unless the switch is locked "open"
 - to prevent the closing of the earthing switches with the unit energised, unless the disconnector and the switch are locked "open"
 - to allow off-load operation of the switch.

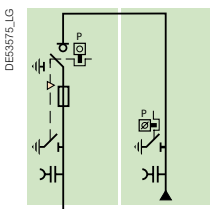

- P5 type**
- to prevent the closing of the earthing switch of the incoming unit unless the disconnector and the switch is locked "open".

Legend for key-type interlocks:

MT20240EN

No key

Key released

Key captive

Panel or door

Notes

Protection, monitoring and control

Protection, monitoring and control

Protection	90
Easergy P3 relay	90
Easergy Sepam selection guide	91
Easergy P5 protection relay	94
VIP 40 and VIP 45 relays	95
VIP 400 and VIP 410 relays	96
Protection and sensor selection table	97
LPCT protection chain	98

Fault passage indicators	100
---------------------------------	------------

Ammeter	103
----------------	------------

Arc fault detectors Easergy Vamp	104
---	------------

Control	105
Motorization control	105
Easergy T200 S for SM6-24	106
Easergy T200 I	107
Automation systems	108
PS100 high-availability power supply	114

Monitoring	115
Thermal monitoring Easergy TH110	115

Protection

Easergy P3 relay

Easergy P3 standard Universal applications



P3U10/20/30 = Universal protection

- Feeder and Transformer
- Motor
- Voltage
- Frequency
- Capacitor

Solid protection meets unparalleled efficiency

The Easergy P3 protection relay family is based on proven technology concepts developed in close cooperation with customers. Easergy products have been designed around user-friendliness, a feature which is proven in our customer feedback day after day.

The Easergy P3 feeder manager has been developed to cover basic protection needs for OEMs, utilities and industrial applications. Thanks to its cost-effective and flexible design, the Easergy P3 provides an excellent alternative for various protection applications.

Easergy P3 combines further protection functions such as directional earth fault for feeder and motor protection.

Unparalleled efficiency

- Simple selection and ordering with EcoReal MV
- Faster delivery with on-the-shelf availability of standard configurations
- Simplified configuration with the new eSetup Easergy Pro setting tool

Better Connectivity

- Simpler operation and maintenance with the Easergy P3 SmartApp
- All communication protocols included natively, including IEC 61850
- Possibility to use two active communication protocols in the same time
- Increased number of inputs and outputs for more possibilities

Enhanced safety

- Embedded arc protection
- Built-in virtual injection testing
- Compliant to international standards (i.e. IEC 60255-1)



Ease of use

User-friendliness is a key benefit of Easergy P3, made to save time at every step of the project's life-cycle.

A great deal of effort has gone into designing the operational aspects of the new products. Setting and download/upload are much faster thanks to the unique eSetup Easergy Pro setting software which dramatically improves usability.

The informative human machine interface shows the information the user needs, with the support of customized legend texts.

Enhanced usability

The Easergy P3 protection relay concept has been extended with a number of features that make installation and testing of the relays even more efficient and user-friendly, like the virtual injection testing accessible with eSetup Easergy Pro setting software.

The Sepam range of protection and metering is designed for the operation of machines and electrical distribution networks of industrial installations and utility substations for all levels of voltage. It consists of complete, simple and reliable solutions, suited to following four families: Sepam series 20, 40, 60 and 80.

A range adapted at your application

- Protection of substation (incoming, outgoing line and busbars).
- Protection of transformers.
- Protection of motors, and generators.

Simplicity

Easy to install

- Light, compact base unit.
- Optional modules fitted on a DIN rail, connected using prefabricated cords.
- User friendly and powerful PC parameter and protection setting software to utilize all of Sepam's possibilities.

User-friendly

- Intuitive User Machine Interface, with direct data access.
- Local operating data in the user's language.

Accurate measurement and detailed diagnosis

- Measuring all necessary electrical values.
- Monitoring switchgear status: sensors and trip circuit, mechanical switchgear status.
- Disturbance recording.
- Sepam self-diagnosis and watchdog.

Flexibility and evolutivity

- Enhanced by optional modules to evolve in step with your installation.
- Possible to add optional modules at any time.
- Simple to connect and commission via a parameter setting procedure.

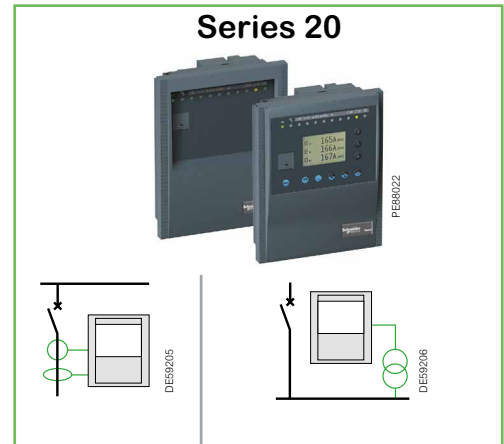

Protections			
Current	•	•	
Voltage			• •
Frequency			• •
Specifics		Breaker failure	Disconnection by rate of change of frequency
Applications			
Substation	S20	S24	
Busbar			B21 B22
Transformer	T20	T24	
Motor	M20		
Generator			
Capacitor			
Characteristics			
Logic inputs	0 to 10		0 to 10
Logic outputs	4 to 8		4 to 8
Temperature sensors	0 to 8		0 to 8
Channel			
Current	3I + I ₀		
Voltage			3V + V ₀
LPCT ⁽¹⁾	•		
Communication ports	1 to 2		1 to 2
IEC61850 Protocol	•		•
Control			
Matrix ⁽²⁾	•		•
Logic equation editor			
Logipam ⁽³⁾			
Other			
Backup battery			
Front memory cartridge with settings			

(1) LPCT: low-power current transformer complying with standard IEC 60044-8.

(2) Control matrix for simple assignment of information from the protection, control and monitoring functions.

(3) Logipam ladder language (PC programming environment) to make full use of Sepam series 80 functions.

(4) Standard lithium battery 1/2 AA format, 3.6 V, front face exchangeable.

Protection

Easergy Sepam selection guide



Protections						
Current	●	●	●	●	●	●
Voltage	●	●	●	●	●	●
Frequency	●	●	●	●	●	●
Specifics		Directional earth fault	Directional earth fault and phase overcurrent		Directional earth fault	Directional earth fault and phase overcurrent
Applications						
Substation	S40	S41, S43	S42	S60		S62
Busbar						
Transformer	T40		T42	T60		T62
Motor		M41			M61	
Generator	G40			G60		G62
Capacitor				C60		
Characteristics						
Logic inputs	0 to 10			0 to 28		
Logic outputs	4 to 8			4 to 16		
Temperature sensors	0 to 16			0 to 16		
Channel						
Current	3 I + I _o			3 I + I _o		
Voltage	3V, 2U + V _o			3V, 2U + V _o or V _{nt}		
LPCT ⁽¹⁾	●			●		
Communication ports	1 to 2			1 to 2		
IEC61850 Protocol	●			●		
Control						
Matrix ⁽²⁾	●			●		
Logic equation editor	●			●		
Logipam ⁽³⁾						
Other						
Backup battery	48 hours			Lithium battery ⁽⁴⁾		
Front memory cartridge with settings				●		

(1) LPCT: low-power current transformer complying with standard IEC 60044-8.

(2) Control matrix for simple assignment of information from the protection, control and monitoring functions.

(3) Logipam ladder language (PC programming environment) to make full use of Sepam series 80 functions.

(4) Standard lithium battery 1/2 AA format, 3.6 V, front face exchangeable.

Protection

Easergy Sepam selection guide



Protections								
Current	•	•	•	•	•	•	•	•
Voltage	•	•	•	•	•	•	•	•
Frequency	•	•	•	•	•	•	•	•
Specifics		Directional earth fault	Directional earth fault and phase overcurrent	Disconnection by rate of change of frequency	Transformer & transformer-machine unit differential	Machine differential	Voltage and frequency protection for 2 sets of busbars	Capacitor-bank unbalance
Applications								
Substation	S80	S81	S82	S84				
Busbar	B80						B83	
Transformer		T81	T82		T87			
Motor		M81			M88	M87		
Generator			G82		G88	G87		
Capacitor								C86
Characteristics								
Logic inputs	0 to 42				0 to 42		0 to 42	0 to 42
Logic outputs	5 to 23				5 to 23		5 to 23	5 to 23
Temperature sensors	0 to 16				0 to 16		0 to 16	0 to 16
Channel								
Current	3I + 2 x Io				2 x 3I + 2 x Io		3I + Io	2 x 3I + 2 x Io
Voltage	3V + Vo				3V + Vo		2 x 3V + 2 x Vo	3V + Vo
LPCT ⁽¹⁾	•				•		•	•
Communication ports	2 to 4				2 to 4		2 to 4	2 to 4
IEC61850 Protocol	•				•		•	•
Control								
Matrix ⁽²⁾	•				•		•	•
Logic equation editor	•				•		•	•
Logipam ⁽³⁾	•				•		•	•
Other								
Backup battery	Lithium battery ⁽⁴⁾				Lithium battery ⁽⁴⁾		Lithium battery ⁽⁴⁾	Lithium battery ⁽⁴⁾
Front memory cartridge with settings	•				•		•	•

(1) LPCT: low-power current transformer complying with standard IEC 60044-8.
 (2) Control matrix for simple assignment of information from the protection, control and monitoring functions.
 (3) Logipam ladder language (PC programming environment) to make full use of Sepam series 80 functions.
 (4) Standard lithium battery 1/2 AA format, 3.6 V, front face exchangeable.

Protection

Easergy P5 protection relay

Easergy P5 is available in two sizes to best fit your needs



Easergy P5 protection relay is based on proven technology concepts and developed in close cooperation with customers, so it's built to meet your toughest demands:

- Modular design that allows user-defined conventional protection and arc-flash protection solutions
- Compatible with conventional CTs/VTs or low power instrument transformers LPCT/LPVT compliant to IEC 61869-10 and IEC 61869-11 standards
- Embeds latest cybersecurity functionality to help prevent intentional miss-use and cyber-threats
- Fast replacement with enhanced safety thanks to withdrawability and back-up memory that automatically restore parameters without using any configuration tools

Easergy P5 is a family of digital protection relays for distribution networks dedicated to:

- **Utilities - Energy distribution**
- **Critical buildings and Industry**
 - Healthcare
 - Transportation
 - Industrial buildings
 - Data Center
- **Large industrial processes**
 - Oil and Gas
 - Mining
 - Mineral and Metals
 - Water

Easergy products are designed to be user friendly, a feature that is proven in our customer reports day after day. You'll benefit from features that include:

- A complete set of protection functions, related to the application
- Arc detection in Easergy P5x30 models
- Dedicated circuit breaker control with single-line diagram, push buttons, programmable function keys, LEDs, and customizable alarms
- Multilingual HMI for customized messaging
- Settings tool relay management software for setting parameters, configuring, and network fault simulation
- Both serial and Ethernet communication, including redundancy
- IEC 61850 standard Edition 1 & Edition 2

Range overview

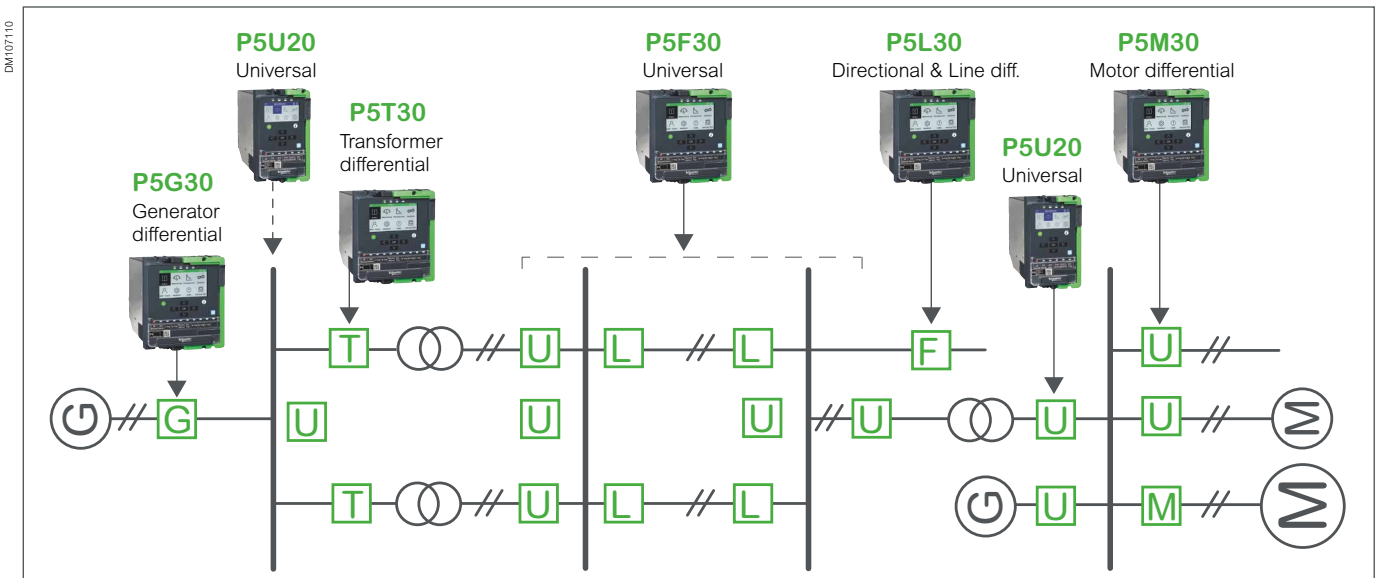

Protection

VIP 40 and VIP 45 relays

Schneider Electric recommends circuit breakers for transformer protection instead of fuses.

They offer the following advantages:

- Easy to set
- Better discrimination with other MV and LV protection devices
- Improved protection performance for inrush currents, overloads, low magnitude phase faults and earth faults
- Greater severe climate withstand
- Reduced maintenance and spare parts
- Availability of additional functions such as measurement, diagnostics and remote monitoring

And with the recent development of less expensive circuit breakers and self-powered relays, life time costs are now equivalent to those of traditional MV switch fuse solutions

Application

- Entry level MV/LV transformer protection
- Dependent-time phase overcurrent tripping curve dedicated to MV/LV transformer protection
- Definite-time earth fault protection
- Phase current and peak demand current measurement

Main features

Self-powered operation

- Energised by the CTs: no auxiliary power needed

Complete pre-tested protection system

- Functional block ready to be integrated

Designed for SM6 to protect transformers

- Designed for D02N 200 A and D01N 100 A circuit breakers to replace fuse-switch solutions
- Setting is as simple as fuse selection
- Maximum setting possibilities consistent with circuit breaker characteristics

Phase overcurrent protection

- Tripping curve optimised for MV/LV transformer protection
- Protection against overloads and secondary and primary short-circuits
- Second harmonic restraint filtering
- Only one setting ($I >$)
- Discrimination with LV circuit breakers or LV fuses
- Compliant with TFL (Time Fuse Link) operating criteria

Earth fault protection

- Definite-time tripping curve
- Settings: $I_0 >$ (phase current sum method) and $I_0 >$
- Second harmonic restraint element

Measurement

- Load current on each phase
- Peak demand current.

Front panel and settings

- Current measurements displayed on a 3 digit LCD
- Settings with 3 dials ($I >$, $I_0 >$, $I_0 >$) protected by a lead-sealable cover
- Trip indication powered by dedicated integrated battery with reset by pushbutton or automatically



Protection

VIP 400 and VIP 410 relays

- VIP 400 is a self-powered relay energised by the CTs; it does not require an auxiliary power supply to operate



Applications

- MV distribution substation incomer or feeder protection relay
- MV/LV transformer protection.

Main features

VIP 400: Self-powered protection relay

This version is energised by the current transformers (CTs). It does not require an auxiliary power supply to operate.

- Overcurrent and earth fault protection
- Thermal overload protection
- Current measurement functions

VIP 410

In addition, the VIP 410 offers enhanced sensitivity to low earth-fault currents and provides additional diagnostics with time-stamped logs thanks to a dual power supply and a communication port.

Protection and sensor for VIP 40/45/400/410

- New sensor dedicated for VIP 40/45/400/410

Rated voltage	Ur	0.72 kV
Insulation voltage	Ud	3 kV - 1 min.
Rated short-time withstand current	Ith (kA)	25
Withstand time	t (s)	3
Rated primary current	I1n	CGA: 0-200 A CGB: 0-630 A
Secondary voltage	Vs	22.5 mV at 100 A
Rated burden		< 2 kΩ
Measurement protection	Accuracy class	CI 1.0 5P30

Protection

Protection and sensor selection table

General common selection of protection units

Protection type	Code	Protection units						
		Easergy P3	Easergy Sepam				VIP	
			series 20	series 40	series 60	series 80	40/45	400
Three-phase overcurrent	50 - 51	●	●	●	●	●	● (2)	● (1)
Zero-sequence overcurrent	50N - 51N	●	●	●	●	●	● (3)	● (1)
Directional zero-sequence current	67N			●	●	●		
Undervoltage	27			●	●	●		
Overvoltage	59			●	●	●		
Thermal image	49	●	●	●	●	●		
Zero-sequence overvoltage	59N			●	●	●		
Negative sequence overcurrent	46	●	●	●	●	●		
Long start-up and rotor blocking	51LR	●	●	●	●	●		
Maximum number of start-ups	66	●	●	●	●	●		
Single-phase undercurrent	37	●	●	●	●	●		
Communication		●	●	●	●	●		

(1) DT, EI, SI, VI and RI trip curves.
 (2) Inverse curve suited to transformer protection.
 (3) DT trip curve.

Protection

LPCT protection chain

Standard applications



Sepam series 20

Demanding applications



Sepam series 40

Custom applications



Sepam series 60 and 80

TLP130, TLP190, CLP2 sensors for Easergy Sepam series 20, 40, 60, 80 protection units

LPCT sensors are voltage-output current sensors

(Low Power Current Transformer) compliant with the IEC 60044-8 standard. These sensors are designed to measure rated current between 5 A and 630 A, with a ratio of 100 A / 22.5 mV.

Sepam series 20, 40, 60 and 80 protection units are at the heart of the LPCT protection chain.

Sepam series 20, 40, 60 and 80 performs the following functions:

- Acquisition of phase currents measured by the LPCT sensors
- Utilization of measurements by the protection functions
- Tripping of the breaking device in case of fault detection.

Advantages

Consistent protection chain with the same sensor measures phase currents from 5 A to 630 A

- Simple to install and implement:
 - Installation of LPCT sensors:
 - TLP130 and TLP190 are installed around MV cable
 - CLP2 is installed on the MV circuit
 - LPCT connected directly to Sepam series 20, 40, 60 and 80
 - Accessories available to test the LPCT protection chain by secondary current injection.

- LPCTs range of use
LPCT measuring and protection function guaranteeing the accuracy up to the short-time current.

Following the range of use of LPCT:

- From 5 A up to 1250 A respecting the error limits imposed by the accuracy class 0.5
- From 1250 A up to 50 kA respecting the error limits imposed by the accuracy class 5P.

Optimized integration of functions:

- Measurement of phase rated currents as of 25 A that is set by micro-switch
- Monitoring of LPCT sensor by Sepam series 20, 40, 60 and 80 (detection of phase loss).

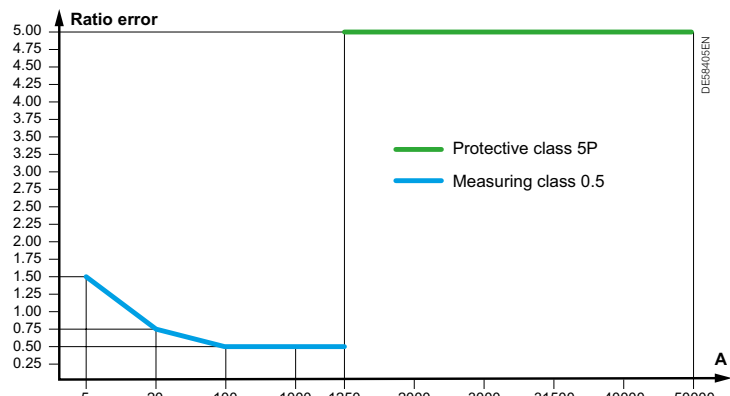

Protection

LPCT protection chain

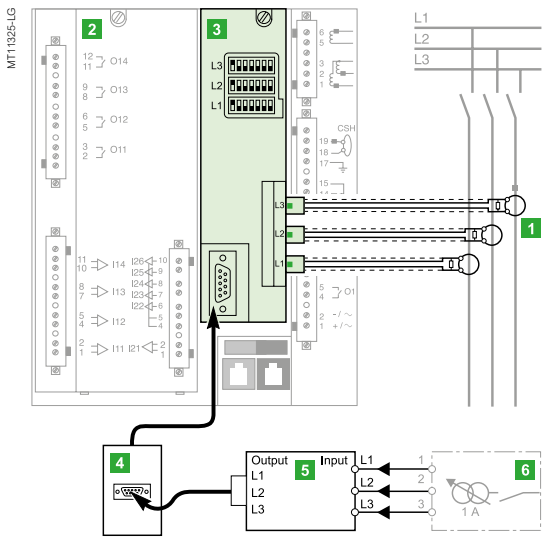

Connections

- 1 LPCT sensor**, equipped with a shielded cable fitted with an RJ45 connector to be connected directly to the card **3**
- 2 Sepam series 20, 40, 60 and 80 protection unit**
- 3 Card interface** that adapts the voltage delivered by the LPCT sensors, with microswitch setting of rated current.
 - CCA671 card for series 60 and 80
 - CCA670 card for series 20 and 40.

Testing and injection

- 4 CCA613 remote test plug**, flush-mounted in front panel of cubicle, equipped with a 3-m cord to be connected to the CCA670 connector test socket (9-pin Sub D)
- 5 ACE917 injection interface**, used to test the LPCT protection chain with a standard injection box
- 6 Standard 1A injection box.**

Fault passage indicators

Flair 21D, 22D and 23DM

Flair 21D, 22D, 23DM is a family of DIN format fault passage indicators. They are small in size, self-powered and adapt automatically to the network.

These devices use cutting-edge technology to detect earth faults on underground MV networks with isolated, resistor-earthed or directly earthed neutral and overcurrents on all networks.

- Self-powered, the fault current passage detection and indication system operates continuously
- Adjustment-free, they are immediately operational (numerous manual adjustments are however possible)
- Compact, their DIN format easily fits in MV cubicles
- Smart, they offer an ammeter/digital maximeter function
- Comprehensive, the Flair 23DM version incorporates a highly sophisticated voltage presence/absence relay function with RJ45 Modbus communication

Applications and main features

The Flair range increases your power availability by providing indicators suitable for fault locating and MV network load management.

- Indication of phase-phase and phase-earth faults
- Display of settings
- Indication of the faulty phase
- Display of the load current including peak demand and frequency
- Fault passage indication and voltage detection combination (Flair 23DM)
- RJ45 communication (Flair 23DM only).

These fault passage indicators are reliable and easy to use.

- Automatic setting on the site
- Fault indication with LED or outdoor lamp
- 15-year battery life for Flair 22D
- More accurate fault detection if Flair 22D or 23DM is connected to voltage presence indication system (VPIS) voltage output
- Can be factory-mounted in SMX cubicles or added on the site
- Easy on-site addition without removing MV cables using split-type current sensor.

Standard applications

Flair 21D

PM108331



Maintenance-free, adjustment-free fault detector

Flair 22D

PM108332



Fault detector for networks with very low load current (< 2 A) with possibility of manual adjustments

Flair 23DM

PM108032



Adapted to Feeder Automation. Forwarding of current measurement, fault passage indication and voltage outage information to the SCADA via a serial communication port. Combination fault passage indicator and voltage detector, ideal for use with an Automatic Transfer System

The Flair 21D, 22D, 23DM range uses an integrated detection system composed of indicators and dedicated CTs. Integrated sensors are normally placed around the bushings. Split CTs can be placed around cables for retrofit purposes.

Display principle

- The load current is displayed continuously
- When a fault is detected, the faulty phase is indicated
- Use the buttons on the front panel to scroll through settings and measurements.

Fault detection functions

Overcurrent detection

- Automatic mode for adjustment-free calibration of detection thresholds
- Manual mode for special override settings:
 - **Flair 21D**: 4 detection thresholds from 200 A to 800 A, in 200 A increments, selectable via microswitches
 - **Flair 22D and Flair 23DM**: 8 detection thresholds from 100 A to 800 A, in 50 A increments, configurable via the front panel keypad.
- Fault acknowledge time:
 - **Flair 21D**: 40 ms
 - **Flair 22D and Flair 23DM** (configurable via the front panel keypad):
 - Type A from 40 to 100 ms in 20 ms increments
 - Type B from 100 to 30 ms in 50 ms increments.

Earth fault detection

The detector checks the 3 phases for current variations (di/dt).

A time delay of 70 s is applied for fault confirmation by the upstream protective device.

- Automatic mode for adjustment-free calibration of detection thresholds
- Manual mode for special override settings:
 - **Flair 21D**: 6 detection thresholds from 40 A to 160 A, via microswitches
 - **Flair 22D and Flair 23DM** (configurable via the front panel keypad):
 - Type A from 20 to 200 A, in 10 A increments
 - Type B from 5 to 30 A in 5 A increments, and 30 to 200 A in 10 A
- Inrush function: prevents unnecessary detection in the event of load switch-on. Incorporates a 3 s time delay for fault filtering at network power up. The Inrush function can be disabled via configuration on Flair 22D and 23DM.

Fault indication function

Signalling

As soon as a fault is confirmed, the indication device is activated.

- Fault indication via a red LED on the front panel
- Indication of the faulty phase (earth fault) on LCD display
- Optional remoting of indication to external flashing lamp
- Activation of a contact for retransmission to the SCADA system.

Indication reset

- Automatic reset upon load current recovery (configurable time delay on Flair 22D and Flair 23DM)
- Manual reset via front panel button
- Reset via external Reset input
- Reset by time delay: fixed (4 hr) for Flair 21D and adjustable using front panel keypad (2 hr to 16 hr) for Flair 22D and Flair 23DM.

Fault passage indicators

Flair 21D, 22D and 23DM

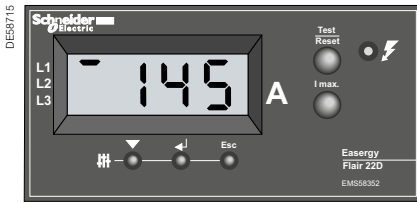

Connection diagrams

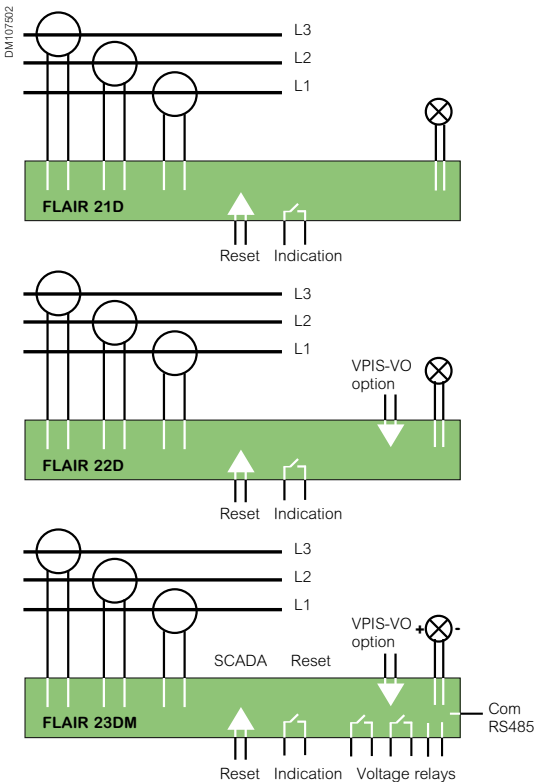

Selection table

		Flair		
		21D	22D	23DM
Power supply	Self-powered	●	●	●
	Dual-powered		● (1)	●
Detection	Overcurrent		●	●
	Earth-fault		●	●
	Ammeter		●	●
	Maximeter		●	●
	SCADA interface (relay)		●	●
Display (4 digit LCD)	External lamp		●	●
	External reset		●	●
	Extended setting (keypad)		●	●
	2-voltage output relays			●
Communication	Serial communication port			●

(1) By lithium battery

Characteristics per product

Model	Description
Fault passage indicator with single power supply (self-powered)	
Flair 21D	Detector with autonomous power supply External indicator lamp output powered by battery (BVP)
Fault passage indicator with dual power supply	
Flair 22D	Detector with autonomous power supply and lithium battery External indicator lamp output powered by the Flair (BVE) Zero sequence CT option (type B setup) Interface with VPIS-VO possible to confirm the fault by voltage absence
Fault passage indicator with dual power supply and voltage presence/absence	
Flair 23DM	Detector with 24-48 Vdc external and autonomous power supply External indicator lamp output powered by the Flair (BVE) Zero sequence CT option (type B or C setup) Voltage presence and absence detector (same as for VD23) Interface with VPIS-VO needed for the voltage presence

Ammeter

- At the leading edge of technology, Amp 21D is suitable for Medium Voltage network load management.
- Self-powered, it ensures a permanent display of currents.
- Compact and in DIN format, it fits naturally into MV cubicles.
- Cost efficient, it uses the CT optimised for Fault Passage Indicator.
- Performant, it displays phase current and maximum of current

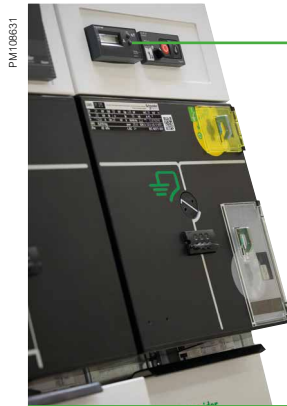

The **SM6** can integrate the **Amp 21D** ammeter on all incoming cubicles and on fuse-switch cubicles

Display principle

- Load currents are permanently displayed, continuous scrolling of L1, then L2, then L3
- Maximeter
 - access to maximeter display by pressing a dedicated push button
 - continuous scrolling of M1, then M2, then M3
 - reset of all maximeter by pressing a combination of two push buttons

Functions

- Display of 3 phase current: I1 , I2 , I3. Range: 3 A to 630 A
- Display of 3 phase current maximeter: I1 , I2 , I3. Range: 3 to 630 A.

Connections, assembly

Small size enclosure

- DIN format: 93 x 45 mm
- Secured, extraction-proof mounting
- Terminal connections.

Current sensors

- Split core CT for mounting on MV cables.

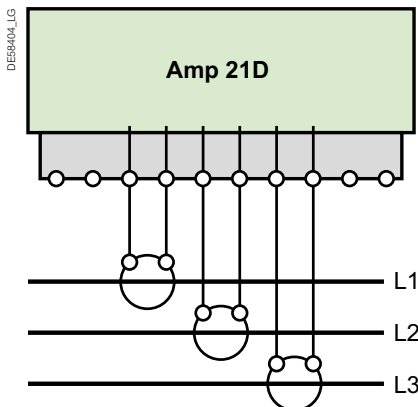

Technical data

Application

Frequency	50 Hz and 60 Hz
Load current	Minimum current ≥ 3 A

Measurement

Range	Phase current	3 to 630 A (resolution 1 A)
	Accuracy (I < 630 A)	$\pm (2\% + 2 \text{ digit})$
Reset of maximeter	Manual from device	Yes

Power supply

Self power	From the current sensors	I load ≥ 3 A
Battery		No
Auxiliary supply		No

Display

Display	4 digits LCD
Current per phase	Yes (resolution 1 A)
Maximeter per phase	Yes

Sensor

Phase CTs	3 split core CT
-----------	-----------------

Miscellaneous

Test	Yes
------	-----

Arc fault detectors Easergy Vamp

Function

The arc protection unit detects an arc flash in an installation and trips the feeding breaker.

An arc flash protection reduces the risk of personal injury and/ or material damage caused by arc faults.

Easergy Vamp 121



System features

- Operation on light only
- Up to 10 arc or smoke sensors
- Single trip contact
- Straightforward installation
- Operation time 9 ms (including the output relay)
- Cost efficient solution
- Self-supervision
- Binary input for blocking or resetting the unit (programmable)
- Possibility for double arc channel activation trip criteria
- BIO light transfer possibility to other Easergy Vamp device

Sensors

Point sensor - Surface

- Arc detection from two compartments simultaneously
- Self-monitored
- Cable length adjustable from 6 m to 20 m down

Point sensor - pipe

- Self-monitored
- Cable length adjustable from 6 m to 20 m down

Portable sensor

- Snap-in connection to I/O unit

Benefits

- Increases protection of personal and property
- Extended switchgear life cycle
- May reduce insurance bill
- Low investment costs and fast installation

The SC110 is an intelligent electronic device designed to control and monitor all the components involved in the remote control of core units.

It integrates all the necessary functions for reliable remote control:

- Electrical interlocking
- Remote control supervision
- Front panel interface for local operation
- Built-in Modbus communication and “Plug and play” design makes the SC110 and the remote control facility:
 - easy to use
 - easy to upgrade.

SC110 universal intelligent controller

SC110 is a compact device with digital inputs and outputs to monitor all the components associated with the electrical operation of the core unit: MCH, MX, XF, auxiliary contacts.

It can be associated with a control panel (SC-MI).

Switchgear control functions

- Coil and motor operation
- Information on switch status: main switch, earthing switch
- Built-in electrical interlocks: anti-pumping and anti-reflex functions
- External interlocking feature
- Lockout of electrical operation after tripping (option)
- Modbus communication for remote control via data transmission

Switchgear monitoring

- Diagnosis information: motor consumption, etc.
- Switch auxiliary contacts status
- Logging of time-stamped events
- Modbus communication for remote indication of monitoring information

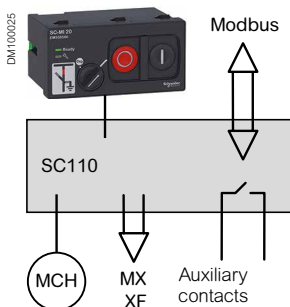

The SC110 is installed in the Low Voltage cabinet of the functional unit. It controls and monitors all the auxiliary contacts needed for electrical operation.

SC110 types	SC110-A	SC110-E
24-60 Vdc	●	
110 Vdc/Vac - 240Vac/250Vdc		●
Network communication	●	●

SC-MI control panels	SC-MI 10	SC-MI 20
On/Off pushbuttons	●	●
Remote/local switch		●

PE18074



Easergy T200 S for SM6-24: remote control interface in LV control cabinet

Easergy T200 S for NSM cubicle

Easergy T200 S is a simplified MV substation control unit for secondary distribution networks enabling remote control of one or two MV substation switches.

T200 S, a version of the T200 unit, is integrated in the SM6 cubicle LV control cabinet. It is limited to control 2 switches. It is intended for remote control applications for source transfer switching and back up generator set switching in NSM cubicle.

Easergy T200 S is a multifunctional "plug and play" interface which integrates all functions required for remote monitoring and control of MV substations:

- Acquisition of various data types: switch position, fault detectors, current values, etc.
- Transmission of opening and closing orders to the switches
- Exchange with the control center.

Particularly used during network incidents, Easergy T200 S has proven its reliability and availability to be able to operate the switchgear at all times. It is easy to implement and operate.

Voltage detection relay

VD23 provides accurate information of presence or absence of voltage.

Associated with VPIS-Voltage Output, VD23 is typically used in critical power and safety applications.

Various combinations of voltage detection are possible:

- 3 Ph-N and residual voltage:
V1 + V2 + V3 + V0
- 3 Ph-N or Ph-Ph voltage:
V1 + V2 + V3 or U12 + U13 + U23
- 1 Ph-N or Ph-Ph or residual voltage:
V1, V2, V3, U12, U13, U23, V0.

VD23 can display the MV network voltage (in % of service voltage), activate the relay output R1 to monitor a loss of voltage on 1 phase at least and active the relay output R2 to monitor a presence of voltage on 1 phase at least.

- Auxiliary power supply: from 24 to 48 Vdc
- Assembly: compact DIN format, mounted in the same place as fault passage indicator (format DIN, integrated in switchgear), terminal connexion fitted with VPIS-Voltage Output

Compatible with all neutral earthing systems.



VD23

Functional unit dedicated to Medium Voltage applications

Easergy T200 S is installed in the low voltage control cabinet of NSM cubicles for remote control of one or two switches.

Easergy notably enables source transfer switching between two switches.

It has a simple panel for local operation to manage electrical controls (local/remote switch) and to display switchgear status information.

It integrates a fault current detector (overcurrent and zero sequence current) with detection thresholds configurable channel by channel (threshold and fault duration).

"Plug and play" and secure

Integrated in the low voltage control cabinet of an MV-equipped cubicle, it is ready to connect to the data transmission system.

Easergy T200 S has been subject to severe tests on its resistance to MV electrical constraints. A back-up power supply guarantees several hours continuity of service for the electronic devices, motorization and MV switchgear.

Current transformers are of split core type for easier installation.

Compatible with all SCADA remote control systems

Easergy T200 S supplies the following standard protocols:

- Modbus serial and IP
- DPN3 serial and IP
- IEC 870-5-101/104.

Data transmission system standards are: RS232, RS485, PSTN, FSK, FFSK, GSM/GPRS.

Other systems are available on request, the radio frequency emitter/receiver is not supplied.

Control

Easergy T200 I



Easergy T200 I: an interface designed for control and monitoring of MV networks

Easergy T200 I is a "plug and play" or multifunction interface that integrates all the functional units necessary for remote supervision and control of the SM6:

- Acquisition of the different types of information: switch position, fault detectors, current values...
- Transmission of switch open/close orders
- Exchanges with the control center.

Required particularly during outages in the network, Easergy T200 I is of proven reliability and availability, being able to ensure switchgear operation at any moment. It is simple to set up and to operate.



Control command
Local information and control



Monitoring and control

Functional unit designed for the Medium Voltage network

- Easergy T200 I is designed to be connected directly to the MV switchgear, without requiring a special converter.
- It has a simple front plate for local operation, which allows management of electrical rating mechanisms (local/remote switch) and display of information concerning switchgear status.
- It has an integrated MV network fault current detection system (overcurrent and zero sequence) with detection set points that can be configured channel by channel (current value and fault current duration).



Back up power supply



Polarized connectors

Medium Voltage switchgear operating guarantee

- Easergy T200 I has undergone severe MV electrical stress withstand tests.
- It is a backed up power supply which guarantees continuity of service for several hours in case of loss of the auxiliary source, and supplies power to the Easergy T200 I and the MV switchgear motor mechanisms.

Ready to plug

- Easergy T200 I is delivered with a kit that makes it easy to connect the motor mechanisms and collect measurements.
- the connectors are polarized to avoid any errors during installation or maintenance interventions.
- current measurement acquisition sensors are of the split type, to facilitate their installation.
- works with 24 Vdc and 48 Vdc motor units.



Split core CTs

Compatible with all SCADA remote control systems

Easergy T200 I supplies the following standard protocols:

- Modbus serial and IP
- DPN3 serial and IP
- IEC 870-5-101/104.

Data transmission system standards are: RS232, RS485, PSTN, FSK, FFSK, GSM/GPRS.

Other systems are available on request, the radio frequency emitter/receiver is not supplied.

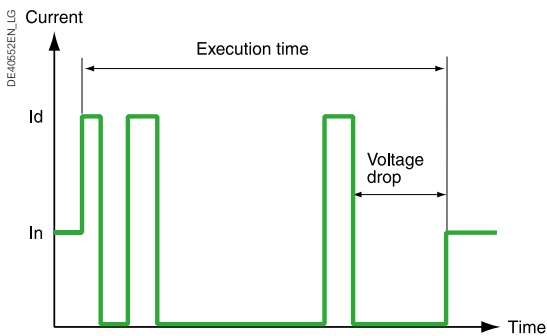

Configurable parameters:

- Number of faults: from 1 to 4
- Execution time: from 20 s to 4 mins configurable in 5 s steps
- Automation system valid/invalid.

Easergy T300 automation systems are factory predefined. No on-site programming is required.

- The automation systems can be switched on and off from the local operator panel and disabled using the configurator.
- Switches can be controlled manually in the following circumstances:
 - automation system switched off
 - switch in local mode.

Sectionaliser (SEC)

The sectionaliser automation system opens the switch after a predefined number of faults (1 to 4) during the voltage dip in the reclosing cycle of the top circuit breaker.

- The automation system counts the number of times a fault current followed by a voltage loss is detected. It sends an open order if:
 - the switch is closed
 - the fault has disappeared
 - the MV supply is absent.
- The automation system is reset at the end of the execution time delay.

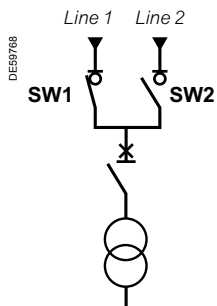

ATS automatic transfer system (source changeover)

The automatic transfer system performs automatic control and management of sources in the MV secondary distribution network.

Two possible versions for ATS:

- **Network ATS version:** control of two MV network channels. The network ATS automatic transfer system requires use of the VD23 relay for detection of voltage presence/absence.
- **Generator ATS version:** control of one network channel and one generating set channel (not available on T200 E).

Note: ATS automatic transfer system is available only on channels 1 and 2 of each CONTROL module. Generator ATS automatic transfer system is available only on the first CONTROL module (channels 1 to 4).

DM106957 **Network ATS: Auto mode SW1**
(with paralleling upon automatic return)

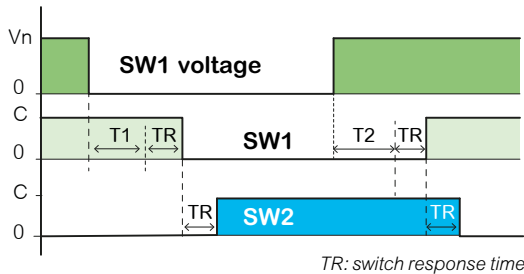

Network ATS: Semi-auto mode
(without paralleling upon automatic return)

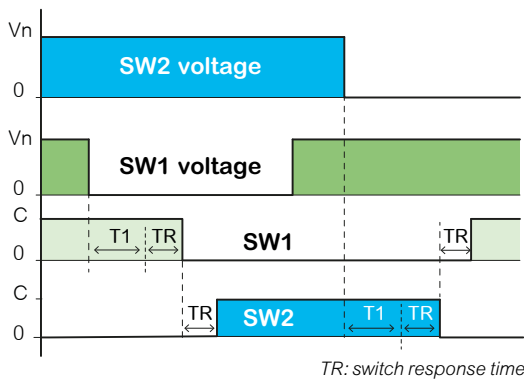

DM106952 **Generator ATS - Auto SW mode**
(without paralleling upon automatic return)

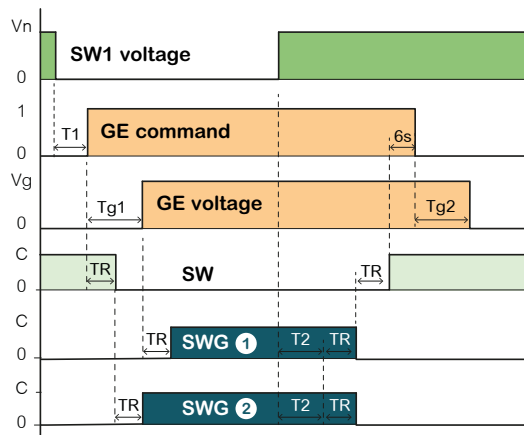

Case ①: Generator channel closing after Generator power on (configurable option)

Case ②: Generator channel closing after Generator startup command (configurable option)

TR: switch response time
Tg1: Generator starting time (maximum 60 s)
Tg2: Generator stopping time

Operating modes

The operating mode is selected from the T200 Web server.

- **Mode SW1→SW2 or SW2→SW1 (or SW→SWG if Generator ATS):**
Automatic transfer system executes only one changeover from the priority channel to the backup channel. Automatic transfer system then remains on that channel.
- **Semi-Auto mode SW1XVSW2 (or SWXVSWG if Generator ATS):**
In the event of a voltage loss on the active channel, automatic transfer system switches to the other channel after a time delay T1. Automatic transfer system executes no return, except in case of voltage loss on the new active channel.
- **Auto SW1 or Auto SW2 mode (or Auto SW if Generator ATS):**
After a changeover, return to the priority channel occurs if the MV voltage on that channel is restored. The channel that has priority can be defined according to the state of a dedicated digital input.

Changeover sequences:

- **Network ATS:** in the event of voltage loss on the normal channel, changeover involves opening the normal channel after time delay T1 and then closing the backup channel.
Note: in "Auto" mode, the sequence of return to the normal channel depends on configuration of the "Paralleling upon auto return" option (see below).
- **Generator ATS:** in the event of voltage loss on the network channel, changeover involves sending the order for opening the network channel and at the same time the Generator start-up order, after time delay T1.

The remainder of the changeover sequence depends on the management of Generator channel closing (configurable option):

- Case of Generator channel closing after start-up order:
After the Generator start-up order, the closing order is given to the Generator channel, without waiting until the Generator is actually started
- Case of Generator closing after Generator power on:
The Generator channel closing order is sent only when Generator voltage is detected.

Configurable parameters:

- Automatic transfer system ON/OFF
- Operating mode: Semi-Auto, Auto SW1, Auto SW2, SW1 → SW2, SW2 → SW1
- T1: 0 ms to 2 min. in increments of 100 ms
- T2: 0 s to 30 min. in increments of 5 s
- Disabling/enabling transfer upon fault detection:
- Choice of voltage presence detection: DI4 or VD23
- Channel connected to generator: SW1 or SW2
- Type of automatic transfer system: Network ATS or Generator ATS
- Manual control enabled/disabled if ATS in operation
- Paralleling enabled/disabled in auto and/or manual mode
- Choice of type of changeover to Generator: immediately or after detection of Generator power on

Paralleling upon Auto return

A software-configurable option allows the automatic transfer system to disable or enable paralleling of the channels upon automatic return to the main channel (in "Auto" mode).

Enabling of paralleling must be confirmed by the activation of a dedicated digital input.

Paralleling disabled: Auto return to the priority channel involves opening the backup channel and, when it is open, closing the priority channel.

Paralleling enabled: Auto return to the priority channel involves first closing the priority channel and, when it is closed, opening the backup channel.

Changeover conditions

Changeover takes place if the following conditions are met:

- Automatic transfer system in operation
- SW1 open and SW2 closed or SW1 closed and SW2 open
- Absence of fault current on the two channels (only if locking by fault detection option activated)
- "Transfer locking" absent
- "Earthing switch" absent on the two channels
- MV voltage absent on the active channel
- MV voltage present on the other channel.

Return to the main channel for the "Auto" modes occurs if:

- The priority channel is open
- The MV voltage on the priority channel is present during time delay T2.

Generating set connections

Relays are installed in factory in the T200 enclosure to provide interfacing with the generating set (Generator ATS version only). Connection should be performed as follows (see diagram opposite):

- **Voltage:** contact closed if Generator started, to be wired on the two available terminals (do not wire if detection of power on is performed by a relay VD23)
- **Start-up:** Generator start-up order, to be wired on terminals **C** and **B**
- **Stop:** Generator stoppage order, to be wired on terminals **D** and **B**.

Detection of voltage presence

Voltage presence on a channel managing the Generator can be executed by two processes:

- Either by a dedicated "Voltage" digital input
- Or by voltage relay VD23 (via cubicle cable).

DE69175

Priority channel

Genset voltage presence

Parallel connection input

Genset forcing

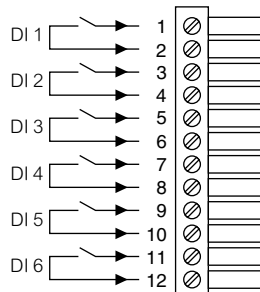

The DIs can be assigned for ATS automation (configurable options)

Digital Input connection ("J2" or "J10" terminal block)

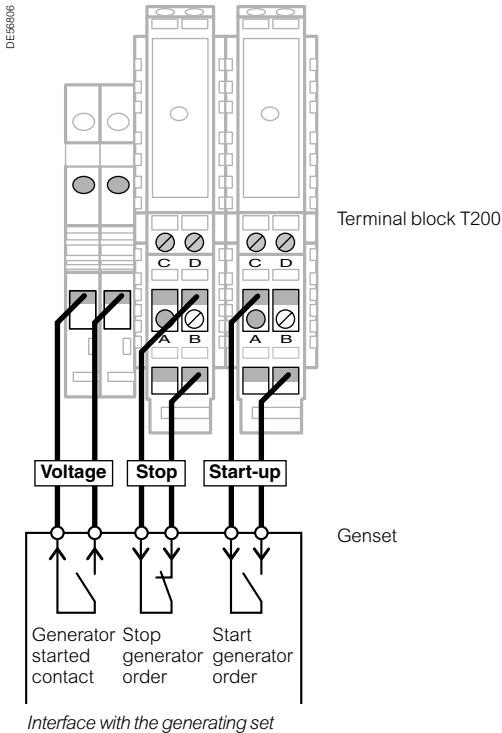

Override setting on generator (Generator ATS only)

For routine test or reduced pricing requirements, it is possible to perform override setting of operation on the generator manually, remotely (from the supervisor) or locally (activation by a dedicated digital input). When the override setting is terminated, the automatic transfer system places itself back in the initial mode, i.e. in the mode that was active before the override setting (ON or OFF). During override setting, the automatic transfer system is set to "ON" for channels 1 and 2.

Source transfer locking

A dedicated digital input allows changeover to be locked if a problem occurs on one of the devices related to the changeover. This input is generally connected to the downstream circuit breaker. Local and remote controls are no longer possible in this case.

Source transfer locking

DO 1

Stop/start generator order

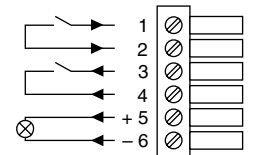

Lock connection ("J1" terminal block on the 4-ways interface or "J9" on the 2-ways interface)

Specific Generator-related management

Upon transfer to the Generator, if the latter doesn't start, the automatic transfer system waits for a period of 60 s at most before stopping changeover, then:

- in SW → SWG mode: the automatic transfer system is locked and must be reset (on the Control panel) to restart the device.
- in SW ↔ SWG mode or in Auto mode: the automatic transfer system remains operational.
If voltage returns to the network channel, the automatic transfer system requests return to the network channel.

When the automatic transfer system is configured with auto return on the network channel, Generator stoppage is requested 6 s after the changeover sequence is completed.

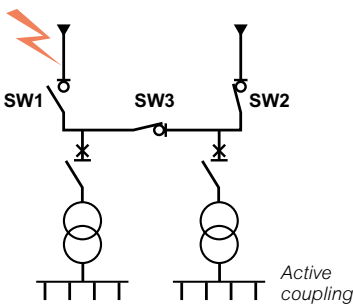
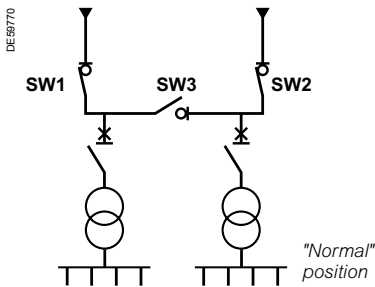

Bus tie coupling (BTA) with T300 I

The BTA (Bus Tie Automatism) is an automation system for switching sources between two incoming lines (SW1 and SW2) and a busbar coupling switch (SW3). It must be used in conjunction with VD23 type voltage presence detectors and the fault current detection function on the busbar incoming lines.

Operating mode

Two operating modes can be configured:

- **Standard mode:**
If the voltage is lost on one busbar, the automation system opens the incoming line (SW1 or SW2) and closes the coupling switch SW3. Coupling is conditional upon the absence of a fault current on the main source.
- **Interlock on loss of voltage after switching mode:**
After execution of the automation system in standard mode, the voltage presence is checked for a configurable period. If the voltage is lost during this period, the coupling switch SW3 is opened and the automation system interlocked.

Coupling sequence

Coupling takes place if the following conditions are met:

- the automation system is switched on
- the switches on incoming channels SW1 and SW2 are closed
- the earthing switches SW1, SW2 and SW3 are open
- there is no voltage on an incoming line SW1 or SW2
- there is no fault current detection on SW1 and SW2
- there is no transfer interlock
- voltage is present on the other incoming line.

The coupling sequence in standard mode is as follows:

- opening of the de-energised incoming line switch after a delay T1
- closing of the coupling switch SW3.

The coupling sequence in "Interlock on loss of voltage after coupling" mode is completed as follows:

- monitoring of the voltage stability for a delay T3
- opening of the coupling switch SW3 if this condition is not met
- locking of BTA automation system.

The system returns to standard mode after coupling if:

- the "return to SW1 or SW2" option is activated
- voltage on the channel has been normal for a delay T2
- the automation system is activated
- the automation system is not locked
- there is no coupling interlock.

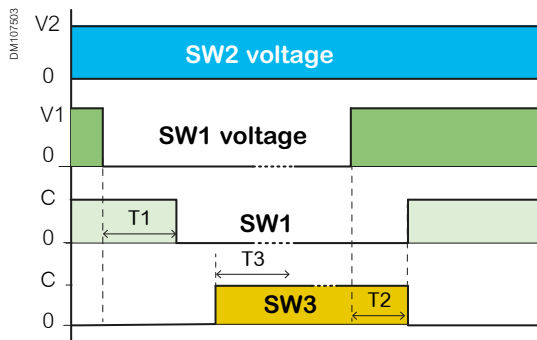

Configurable parameters:

- Operating mode:
Standard/locking upon voltage loss
- Automatic return: SW1/SW2
- Automation system: on/off
- Delay before switching
T1: 100 ms to 60 s in 100 ms steps
- Delay before return
T2: 5 s to 300 s in 1 s steps
- Interlock delay on voltage loss
T3: 100 ms to 3 s in 100 ms steps
- Motorisation type: command time
- Manual control: enabled/disabled in local and remote modes if automation system in operation
- Paralleling: enabled/disabled in auto and (or) manual modes
- Transfer locking upon fault detection.

Coupling interlock

A dedicated digital input allows changeover to be locked if a problem occurs on one of the devices related to the changeover. This input is generally connected to the downstream circuit breaker. Local and remote controls are no longer possible in this case.

Locking the automation system

The BTA automation system is locked if one of the following conditions is met during the coupling process:

- Failure of a command to open or close a switch
- Indication that an earthing switch has closed
- Appearance of a fault current
- Switch power supply fault
- Appearance of the coupling interlock
- Manual or remote ON/OFF command from the automation system.

Paralleling upon Auto return

A software-configurable option allows the automation system to disable or enable paralleling of the channels upon automatic return to the main channel (in "Auto" mode). Enabling of paralleling must be confirmed by the activation of a dedicated digital input.

- **If paralleling is disabled:** Auto return to the normal channel involves opening the coupling channel (SW3) and, when it is open, closing the normal channel.
- **If paralleling is enabled:** Auto return to the normal channel involves first closing the normal channel and, when it is closed, opening the coupling channel (SW3).

Backup solution for MV switchgear power needs in the event of micro outages and power interruptions.

- Easy maintenance with only one battery
- Remote battery monitoring
- High level of insulation to protect the electronic devices in severe MV environments
- End-of-life alarm possible via Modbus communication
- Compliant with standards IEC 60255-5 (10 kV level).

PS100 backup power supply for MV substations



Applications

The power supply unit supplies backup operating power for:

- MV switchgear motor mechanisms and circuit breaker coils
- Transmission equipment (e.g. radio)
- Control units such as RTU or Automatic Transfer System
- Protection relays, Fault Passage Indicators and others electronic devices.

Benefits

Only one battery

Traditional backup power supplies require a set of 2 or 4 batteries to produce 24 V or 48 V, with complicated replacement and adjustment of the battery pack.

The PS100 needs only one battery, simplifying replacement.

The battery is a standard sealed lead-acid 12 V battery with a 10-year service life. It can be purchased easily, anywhere in the world.

Improved availability of MV/LV substations

The PS100 is designed to ride through power network interruptions of up to 48 hours. It is associated with a battery selected to meet the required backup time.

The PS100 protects and optimises the battery with state-of-the-art monitoring.

A Modbus communication port forwards monitoring data to allow optimised maintenance operations.

Perfect integration with the Easergy range to control and monitor your distribution network.

Additional energy backup

The PS100 stops supplying power and reserves an "additional energy backup" to restart the installation after an extended power interruption.

The "additional energy backup" can be enabled with a local pushbutton to provide energy for restarting the protection relays and operating the MV switchgear.

Withstands severe substation environments

The PS100 includes 10 kV insulation, electronic protection against overvoltage and overloads, and automatic restart after a fault.

High availability power supply

A battery ensures uninterrupted operation of the whole substation in the event of loss of the main supply. The backup power supply unit:

- Includes a regulated and temperature-compensated charger
- Stops the battery before deep discharge
- Carries out a battery check every 12 hours
- Measures battery ageing
- Forwards monitoring information via a Modbus communication port and output relays.

Main features

- DIN rail mounting for easy integration in any LV cabinet or MV/LV substation
- 2 power supply outputs:
 - 12 Vdc - 18 W continuous - 100 W 20 s (for modem, radio, RTU, etc.)
 - 48 Vdc or 24 Vdc - 300 W / 1 minute (for switchgear operating mechanism motors) and 90 W / continuous for protection relays, electronic devices, etc.
- RJ45 Modbus communication port
- 2 output relays (AC supply ON, Battery ON)
- Diagnosis with LEDs
- 1 sealed lead-acid 12 V battery with a 10-year service life (from 7 Ah to 40 Ah)
- Power supply paralleling available with a 2nd PS100
- -40°C to +70°C operating temperature.

Range

- PS100-48V 48 Vdc power supply and battery charger
- PS100-24V 24 Vdc power supply and battery charger
- Bat24AH 24 Ah long life battery
- Bat38AH 38 Ah long life battery.



Easergy TH110

Continuous Thermal Monitoring

The power connections in the Medium Voltage products are one of the most critical points of the substations especially for those made on site like:

- MV Cable connections

Loose and faulty connections cause an increase of resistance in localized points that will lead to thermal runaway until the complete failure of the connections.

Preventive maintenance can be complicated in severe operating conditions also due to limited accessibility and visibility of the contacts.

The continuous thermal monitoring is the most appropriate way to early detect a compromised connection.

Easergy TH110 Thermal Sensor

Easergy TH110 is part of the **new generation of wireless smart sensors** ensuring the continuous thermal monitoring of all the critical connections made on field allowing to help:

- Prevent unscheduled downtimes
- Increase operators and equipments safety
- Optimize predictive maintenance

Thanks to its very **compact footprint** and its **wireless communication**, Easergy TH110 allows an easy and widespread installation in every possible critical points without impacting the performance of the MV Switchgears.

By using **Zigbee Green Power** communication protocol, Easergy Th110 ensures a reliable and robust communication that can be used to create interoperable solutions evolving in the Industrial **Internet of Things (IIoT)** age.

Easergy TH110 is **self powered** by the network current and it can ensure **high performances** providing accurate thermal monitoring being in **direct contact** with the measured point.

All SM6 cubicles for private market are fitted with thermal sensors on each cable termination. This will enable users to measure the temperature and verify the health of connection at any point of time.



Easergy CL110

Easergy CL110 ambient monitoring

Schneider Electric ambient monitoring system will continuously:

- Help maintenance manager to avoid deterioration of the MV switchgear due to moisture and pollution
- By automatically calculating the condensation cycle, and combining it with the declared mission profile conditions, the system will recommend maintenance and cleaning frequency adjustment in order to maintain the switchgear in its nominal status

Connections

Connections

Connections with dry-type cables for SM6-24	118
Selection table	118

Cable-connection from below for SM6-24	120
Cable positions	120
Trenches depth	121
Trench diagrams example	123
Trench diagrams and floor void drawings	125

Connections with dry-type cables for SM6-36	126
Selection table	126

Cable-connection from below for SM6-36	128
Cable positions	128

Cabling from above for SM6-24 and SM6-36	129
---	------------

Connections with dry-type cables for SM6-24

Selection table



- Access to the compartment is interlocked with the closing of the earthing disconnecter.
- The reduced cubicle depth makes it easier to connect all phases.
- A 12 mm Ø pin integrated with the field distributor enables the cable end terminal to be positioned and attached with one hand. Use a torque wrench set to 50 mN.



Round connector

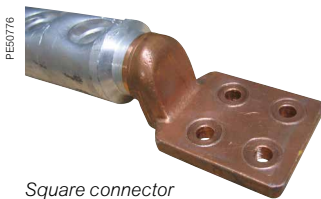

Square connector

The ageing resistance of the equipment in an MV/LV substation depends on three key factors:

- **The need to make connections correctly**
New cold fitted connection technologies offer ease of installation that favours resistance over time. Their design enables operation in polluted environments under severe conditions.
- **The impact of the relative humidity factor**
The inclusion of a heating element is essential in climates with high humidity levels and with high temperature differentials.
- **Ventilation control**
The dimension of the grills must be appropriate for the power dissipated in the substation. They must only traverse the transformer area.

Network cables are connected:

- on the switch terminals
- on the lower fuse holders
- on the circuit breaker's connectors.

The bimetallic cable end terminals are:

- round connection and shank for cables $\leq 240 \text{ mm}^2$
- square connection round shank for cables $> 240 \text{ mm}^2$ only.
- Crimping of cable end terminals to cables must be carried out by stamping.

The end connectors are of cold fitted type

Schneider Electric's experience has led it to favour this technology wherever possible for better resistance over time.

The maximum admissible cable cross section:

- 630 mm^2 for 1250 A incomer and feeder cubicles
- 240 mm^2 for 400-630 A incomer and feeder cubicles
- 120 mm^2 for contactor cubicles
- 95 mm^2 for transformer protection cubicles with fuses.

Connections with dry-type cables for SM6-24

Selection table

Dry-type single-core cable

Short inner end, cold fitted

Performance	Cable end terminal type	X-section mm ²	Supplier	Number of cables	Comments
3 to 24 kV 400 A - 630 A	Round connector	50 to 240 mm ²	All cold fitted cable end suppliers: Silec, 3M, Pirelli, Raychem, etc.	1 or 2 per phase	For larger x-sections, more cables and other types of cable end terminals, please consult us
3 to 24 kV 1250 A	Round connector	50 to 630 mm ²	All cold fitted cable end suppliers: Silec, 3M, Pirelli, Raychem, etc.	1 or 2 per phase ≤ 400 mm ²	For larger x-sections, more cables and other types of cable end terminals, please consult us
	Square connector	> 300 mm ² admissible		400 < 1 ≤ 630 mm ² per phase	

Three core, dry cable

Short inner end, cold fitted

Performance	Cable end terminal type	X-section mm ²	Supplier	Number of cables	Comments
3 to 24 kV 400 A - 630 A	Round connector	50 to 240 mm ²	All cold fitted cable end suppliers: Silec, 3M, Pirelli, Raychem, etc.	1 per phase	For larger x-sections, more cables and other types of cable end terminals, please consult us
3 to 24 kV 1250 A	Round connector	50 to 630 mm ²	All cold fitted cable end suppliers: Silec, 3M, Pirelli, Raychem, etc.	1 per phase	For larger x-sections, more cables and other types of cable end terminals, please consult us

Note:

- The cable end terminals, covered by a field distributor, can be square,
- PMI/QM type cubicle, round end connections Ø 30 mm max.

Cable-connection from below for SM6-24

Cable positions

Cable-connection height H measured from floor (mm)

	630 A	1250 A
IM, NSM-cables, NSM-busbars	945	
SM	945	945
IMC	400	
PM, QM	400	
QMC	400	
CVM	430	
DMV-2	430	320
DMVL-A	430	
DMV-W	370	320
GAM2	760	
GAM	470	620
DMV-A	320	313

IM, NSM-cables, NSM-busbars, SM

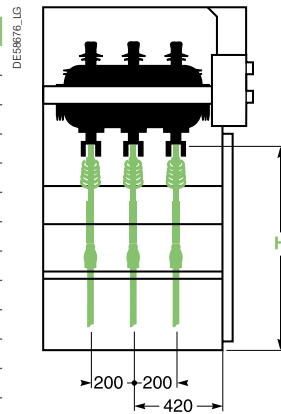

IMC, PM, QM, QMC

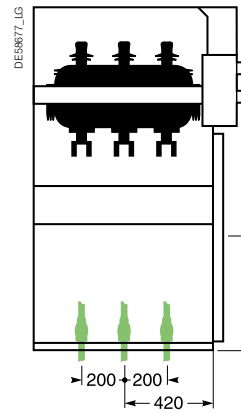

CVM

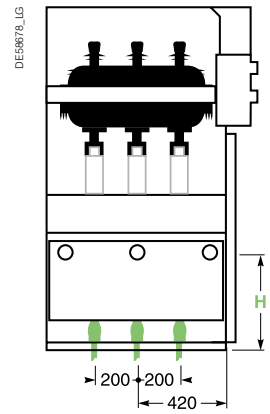

GAM, GAM2

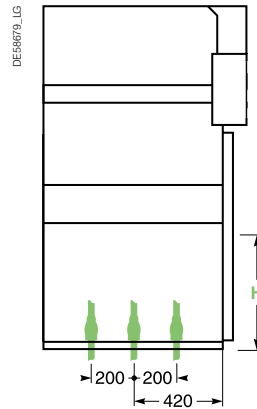

DMV-A (630 A)

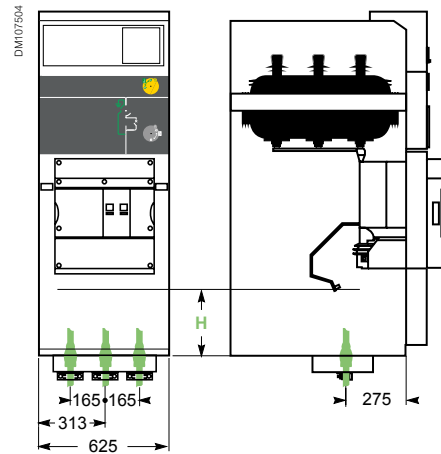

DMVL-A DMV-W (630 A)

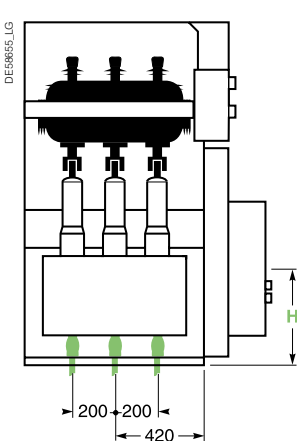

DMV-W (1 250 A)

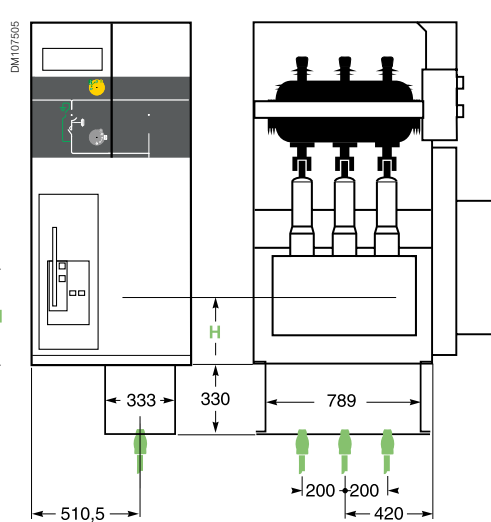

DMV-A (1 250 A)

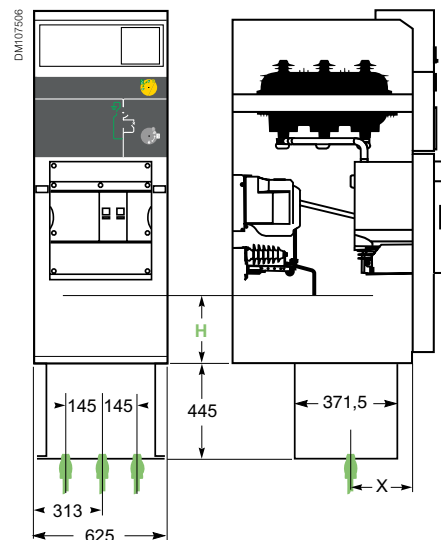

- X = 330: 1 single-core cable
- X = 268: 2 single-core cables
- X = 299: 1 three core cable

Cable-connection from below for SM6-24

Trenches depth

For internal arc 12.5 kA 1s, IAC: A-FL

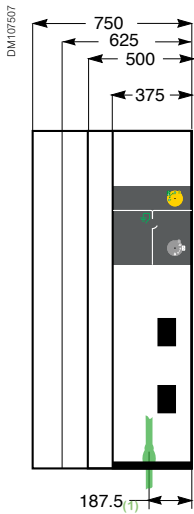

Note: the unit and the cables requiring the greatest depth must be taken into account when determining the depth **P** or single-trench installations. In double-trench installations, depth **P** must be taken into account for each type of unit and cable orientations.

- **Through trenches:** the trench depth **P** is given in the table opposite for commonly used dry single-core cables type (for tri-core cables consult us).
- **With stands:** to reduce **P** or eliminate trenches altogether by placing the units on 400 mm concrete footings.
- **With floor void:** the trench depth **P** is given in the table opposite for commonly used types of cables.

Single-core cables		Units until 630 A					1250 A units		
Cable x-section (mm ²)	Bending radius (mm)	IM, SM, NSM-cables, NSM-busbars	IMC, DM1-A, DM1-W, DM1-S, DMVL-A, GAM	CRM CVM	DMV-A,	PM, QM, QMC (1)	SM, GAM	DM1-A (2) DM1-W (2)	DMV-A (3)
		Depth P (mm) all orientations							
		P1	P2	P2	P2	P3	P4	P5	P6
50	370	140	400	400	500	350			
70	400	150	430	430	530	350			
95	440	160	470	470	570	350			
120	470	200	500	500	600				
150	500	220	550		650				
185	540	270	670		770				
240	590	330	730		830				
400	800						1000	1350	1450
630	940						1000	1350	1450

(1) Must be installed with a 100 mm depth metal pan. / (2) Must be installed with a 350 mm depth metal pan, in a floor void. / (3) Mounting with a 445 mm depth metal pan compulsory in a floor void.

Cable trench drawings

1250 A units (represented without switchboard side panels)

SM, GAM
For single and tri-core cables

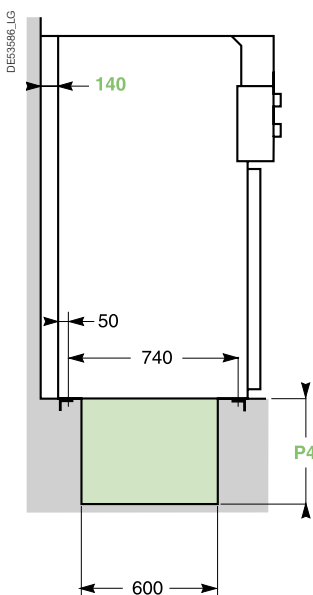

DMV-A
For single and tri-core cables

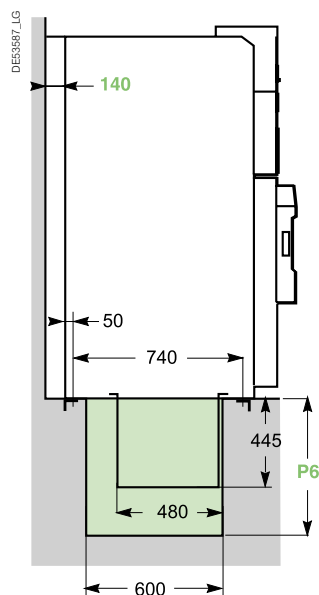

DM1-A, DM1-W
For single-core cables

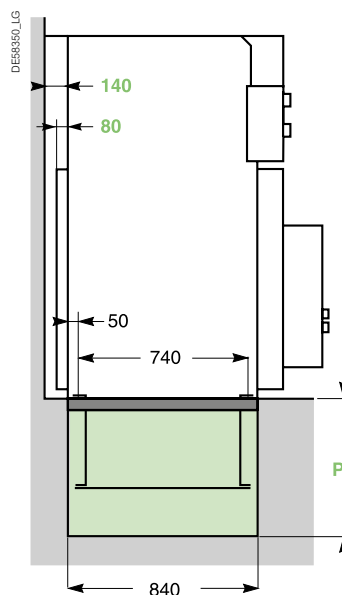

630 A units

DMV-A
For single cables

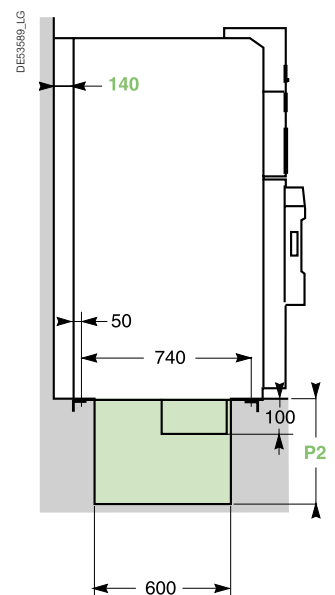

Cable-connection from below for SM6-24

Trenches depth

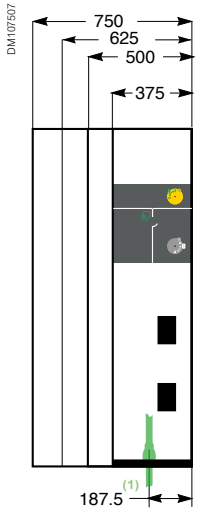

Note: the unit and the cables requiring the greatest depth must be taken into account when determining the depth **P** or single-trench installations. In double-trench installations, depth **P** must be taken into account for each type of unit and cable orientations.

(1) Except DMV-A

For internal arc 12.5 kA 1s, IAC: A-FLR, 16 and 20 kA 1s, IAC: A-FL/A-FLR

- **Through trenches:** the trench depth **P** is given in the following table for usual dry single-core cables type (for tri-core cables consult us)
- **With stands:** to reduce **P** or avoid trenches, by placing the units on 400 mm concrete footings.
- **With floor void:** the trench depth **P** is given in the following table for usual types of cables.

		630 A						1250 A			
		DMVA	CVM		DM1A, DM1S, DM1W, DMVLA		All other cubicles (except DMVA, CVM, DM1A, DM1S, DM1W, DMVLA)		SM, GAM	DM1A, DMV-A, DM1-W	
IAC (kA/1s)		12-16	12.5	16	12.5	16	12.5	16	12-16	12-16	
Cable section (mm ²)	S < 120	550	330	550	330	550	330	550			
	120 < S < 240	800			330 Cables coming other side of the circuit breaker	450 Cables coming under the circuit breaker	550	330	550		
	S > 400								1000	1400	
		Depth P (mm)									

Cable trench drawings

1250 A units (represented without switchboard side panels)

SM, GAM

For single and tri-core cables

DMV-A

For single and tri-core cables

DM1-A, DM1-W

For single-core cables

630 A units

DMV-A

For single cables

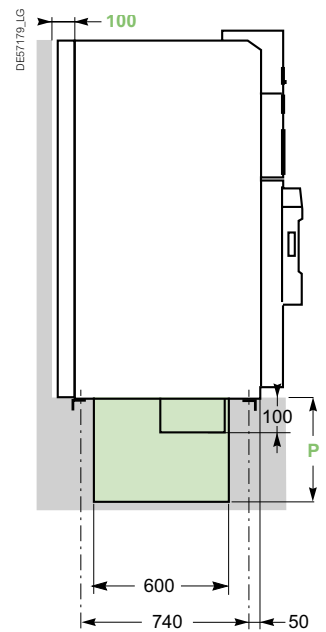
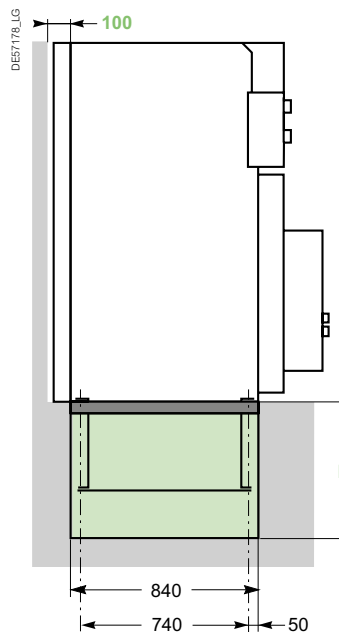
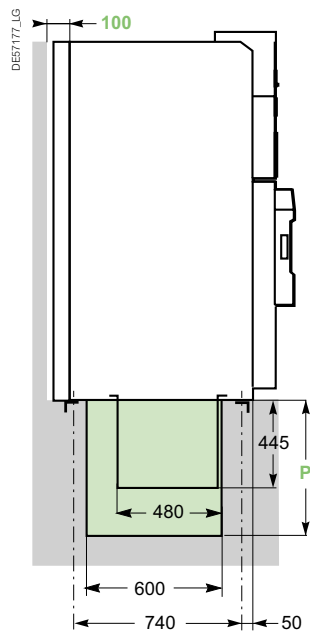
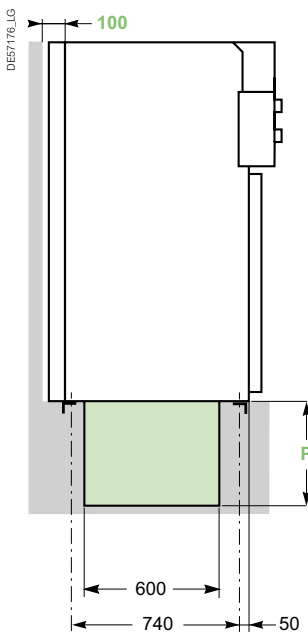

Cable-connection from below for SM6-24

Trench diagrams example

For internal arc 12.5 kA 1s, IAC: A-FL

Units represented without switchboard side panels

630 A units

Cable entry or exit through right or left side

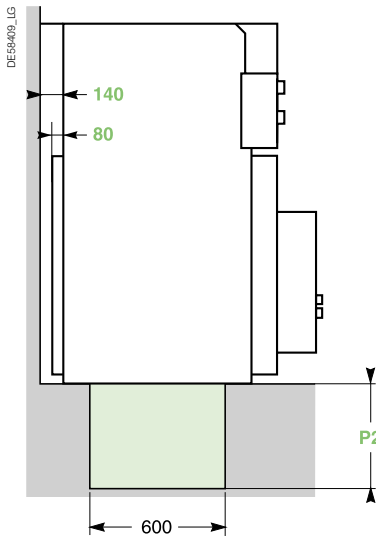

630 A units

Rear entry or exit with conduits

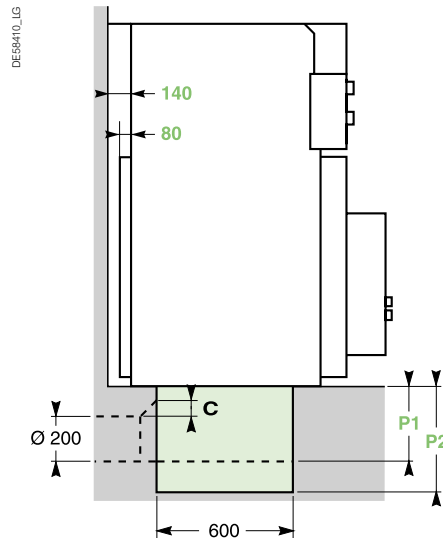

630 A units

Front entry or exit with conduits

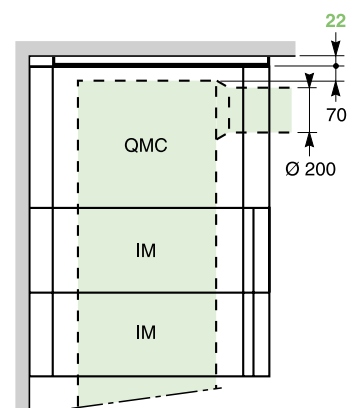
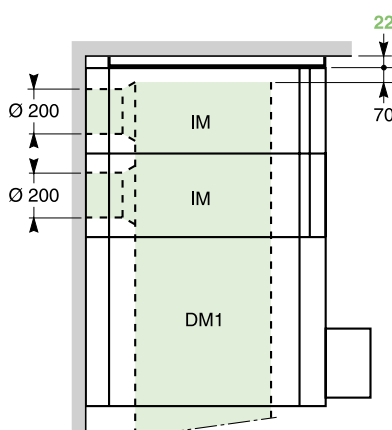
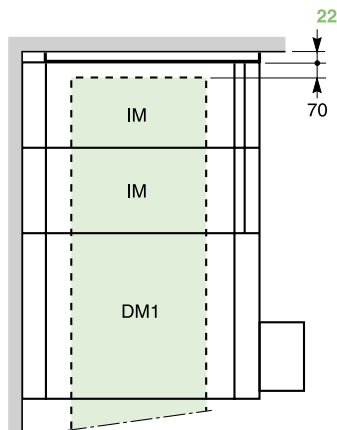
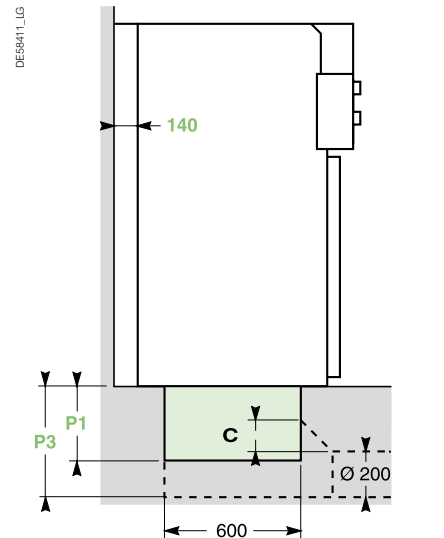

Required dimensions (mm)

Note 1: for connection with conduits, the bevel (C) must correspond to the following trench dimensions: P1 = 75 mm or P2/P3 = 150 mm.

Note 2: please refer to chapter "Layout examples" for a site application.

Cable-connection from below for SM6-24

Trench diagrams example

For internal arc 12.5 kA 1s,
IAC: A-FLR, 16 and 20 kA 1s, IAC: A-FL/A-FLR

Units represented without switchboard side panels

630 A units
Cable entry or exit through right or left side

630 A units
Rear entry or exit with conduits

630 A units
Front entry or exit with conduits

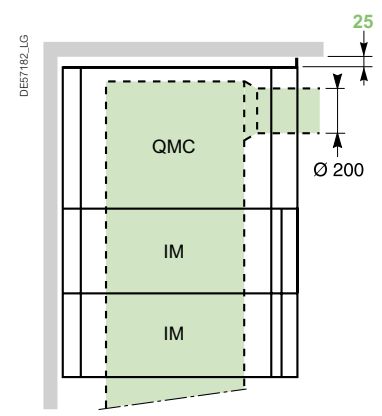
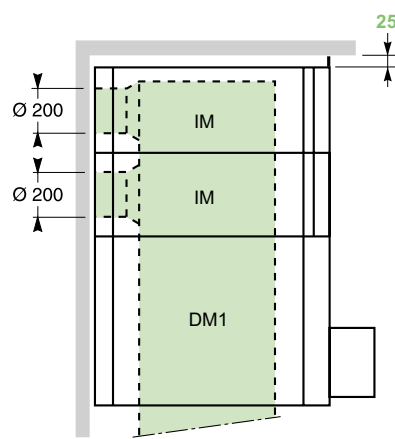
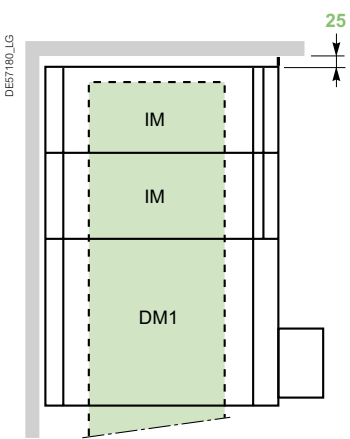
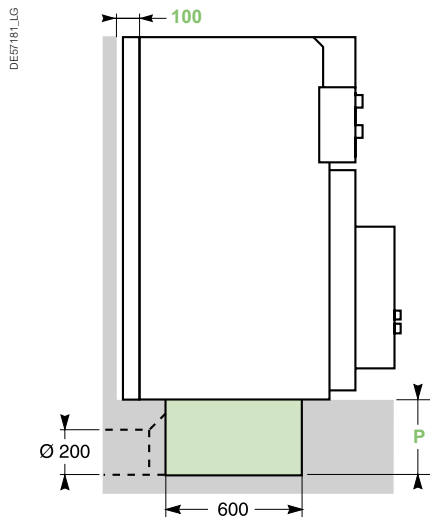

Required dimensions (mm)

Cable-connection from below for SM6-24

Trench diagrams and floor void drawings

Example: Installation with floor void for 16 kA 1 s downwards exhaust

Area free of obstructions:

Width	Cubicles	XG (mm)	X (mm)	XD (mm)
375	All	57.5	260	57.5
500	GAM	57.5	260	182.5
	Other	182.5	260	57.5
625	QMC	307.5	260	57.5
	Other	57.5	510	57.5
750	All	432.5	260	57.5

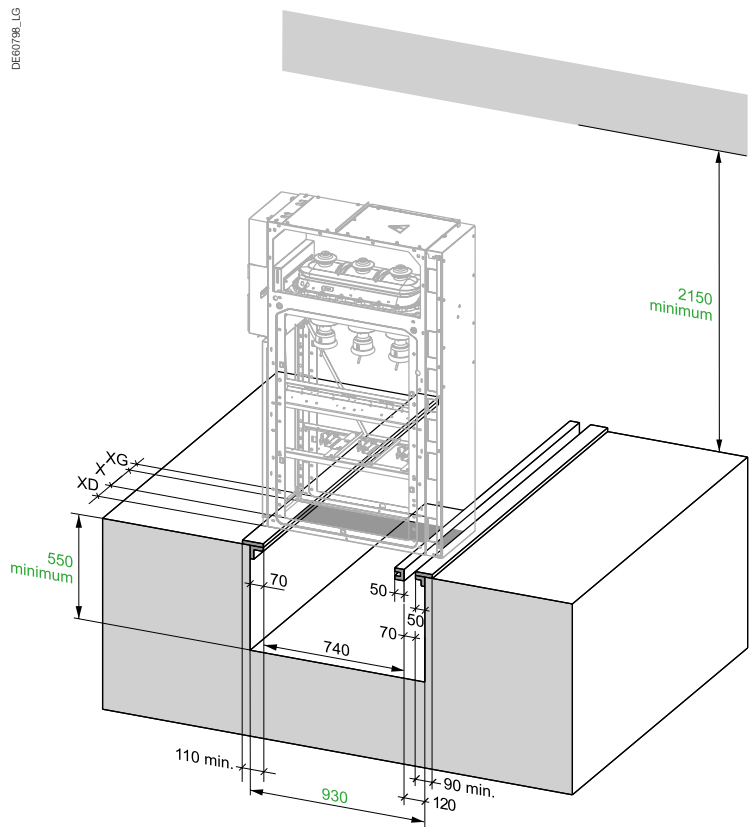

Example: Installation with cable trench
 - for basic 12.5 kA 1 s downwards exhaust,
 - for advance 16 kA 1 s and 20 kA 1 s upwards exhaust

Position of fixing holes *b* depends on the width of the unit:

Cubicle width (mm)	<i>b</i> (mm)
125	95
375	345
500	470
625	595
750	720

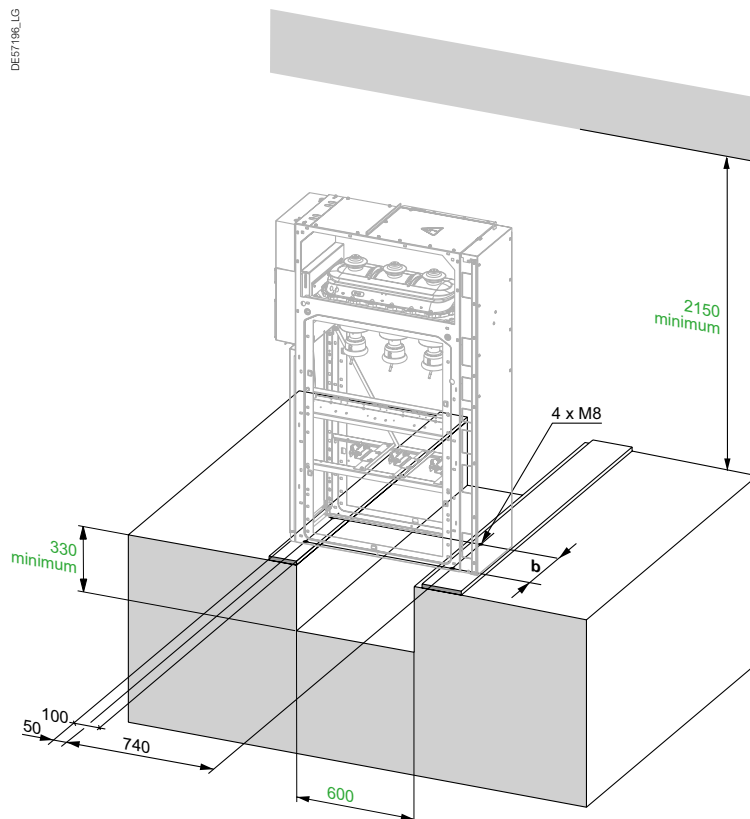

Connections with dry-type cables for SM6-36

Selection table

Single-core cables		Units 630 A	
Cable-section (mm ²)	Bending radius (mm)	IM, IMC, QM, CM, CM2, PM, DM1-A, GAM, GAM2, SM, TM	
		Depth P (mm)	
		P1	P2
1 x 35	525	350	550
1 x 50	555	380	580
1 x 70	585	410	610
1 x 95	600	425	625
1 x 120	630	455	655
1 x 150	645	470	670
1 x 185	675	500	700
1 x 240	705	530	730

Note: the unit and the cables requiring the greatest depth must be taken into account when determining the depth P for single-trench installations. In double-trench installations must be taken into account to each type of unit and cable orientations.

For internal arc 12.5 kA 1s,
IAC: A-FLR, 16 and 20 kA 1s, IAC: A-FL/A-FLR

The ageing resistance of the equipment in an MV/LV substation depends on three key factors:

- **The need to make connections correctly**
New cold fitted connection technologies offer ease of installation that favours resistance over time. Their design enables operation in polluted environments under severe conditions.
- **The impact of the relative humidity factor**
The inclusion of a heating element is essential in climates with high humidity levels and with high temperature differentials.
- **Ventilation control**
The dimension of the grills must be appropriate for the power dissipated in the substation. They must only traverse the transformer area.

Network cables are connected:

- On the switch terminals
- On the lower fuse holders
- On the circuit breaker's connectors.

The bimetallic cable end terminals are:

- Round connection and shank for cables $\geq 240 \text{ mm}^2$.
Crimping of cable lugs to cables must be carried out by stamping.

The end connectors are of cold fitted type

Schneider Electric's experience has led it to favour this technology wherever possible for better resistance over time.

The maximum admissible copper(*) cable cross section:

- 2 x (1 x 240 mm² per phase) for 1250 A incomer and feeder cubicles
- 240 mm² for 630 A incomer and feeder cubicles
- 95 mm² for transformer protection cubicles with fuses.

Access to the compartment is interlocked with the closing of the earthing disconnector.

The reduced cubicle depth makes it easier to connect all phases.

A 12 mm Ø pin integrated with the field distributor enables the cable end terminal to be positioned and attached with one hand. Use a torque wrench set to 50 mN.

(*) Consult us for alu cable cross sections

Connections with dry-type cables for SM6-36

Selection table

Cabling from below

All units through trenches

- The trench depth P is given in the table opposite for commonly used types of cables.

Trench diagrams

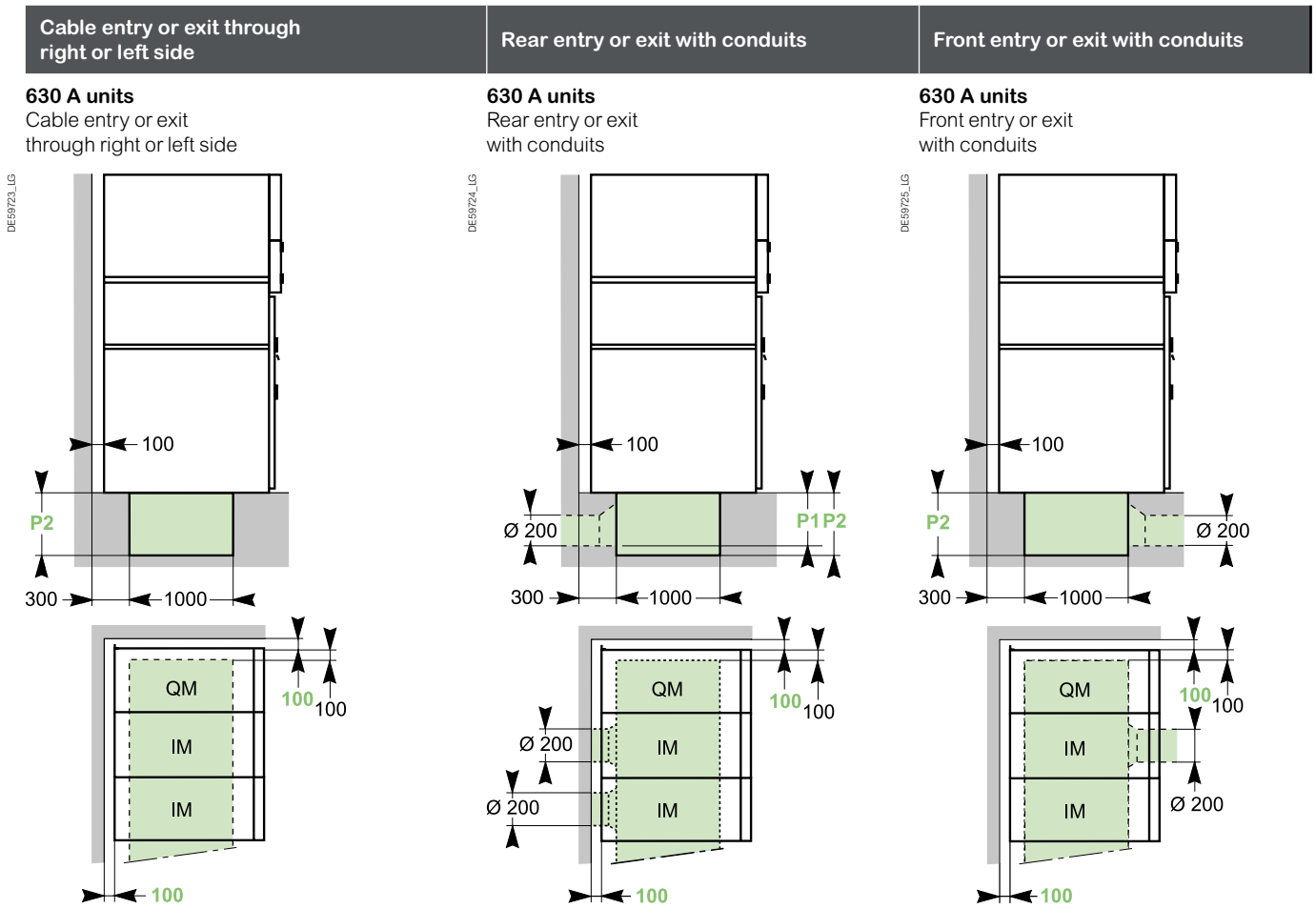

Note: Dimensions in mm

Cable-connection from below for SM6-36

Cable positions

Side view

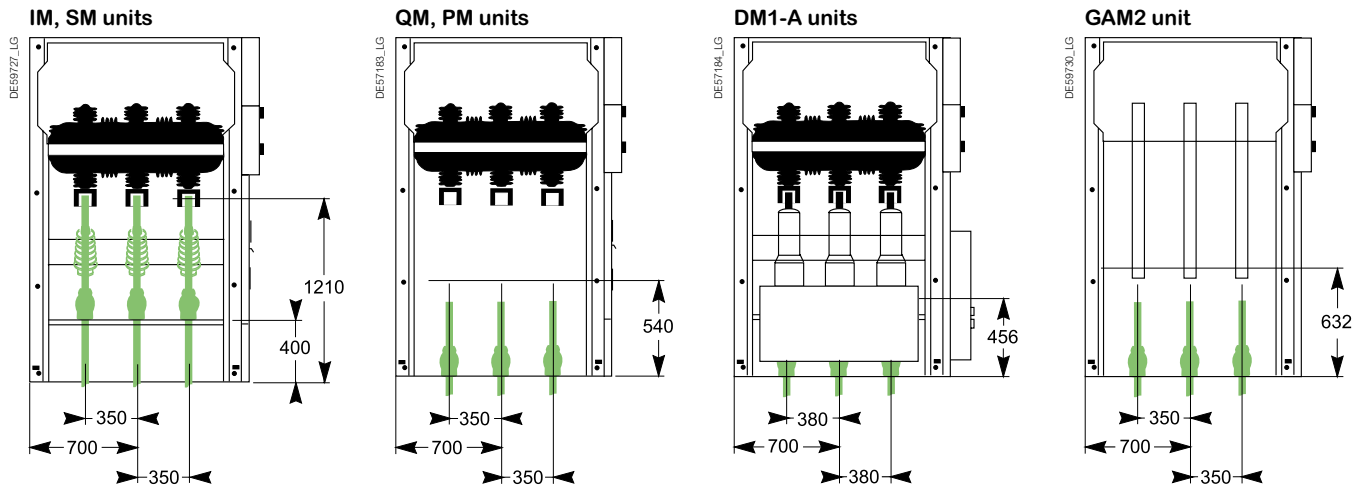

Front view

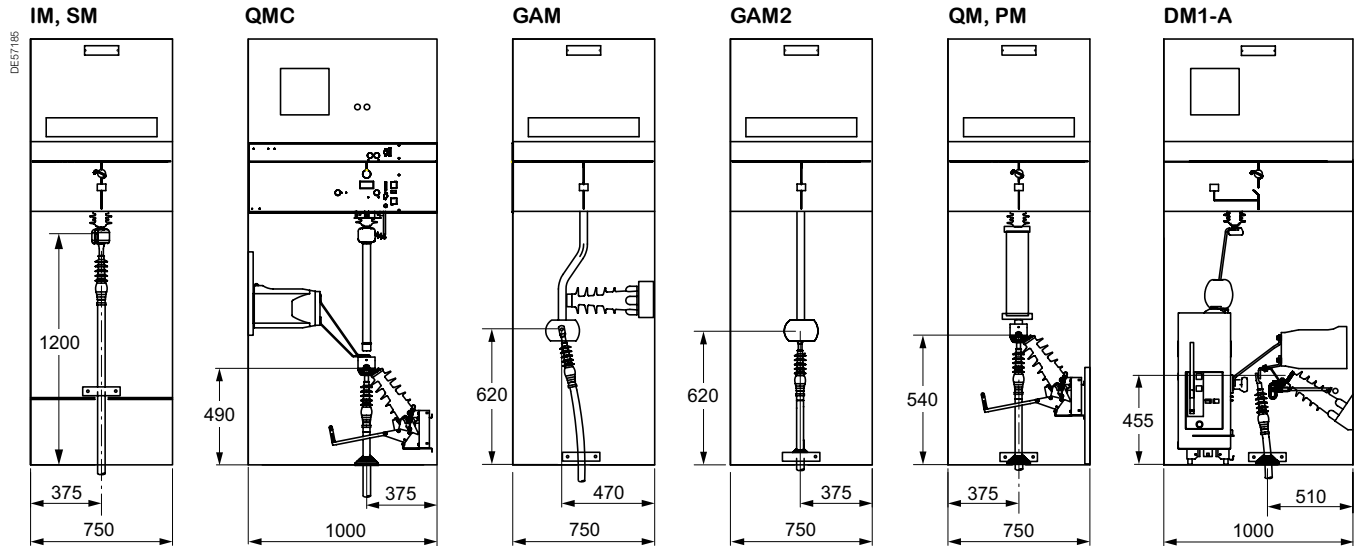

Cabling from above for SM6-24 and SM6-36

On each 630 A unit of the range, except those including a low-voltage control cabinet and an EMB enclosure, the connection is made with dry-type and single-core cables.

Remarks:

- Not available for internal arc IEC 62271-200.
- Not available in 1250 A.

PE50797_G

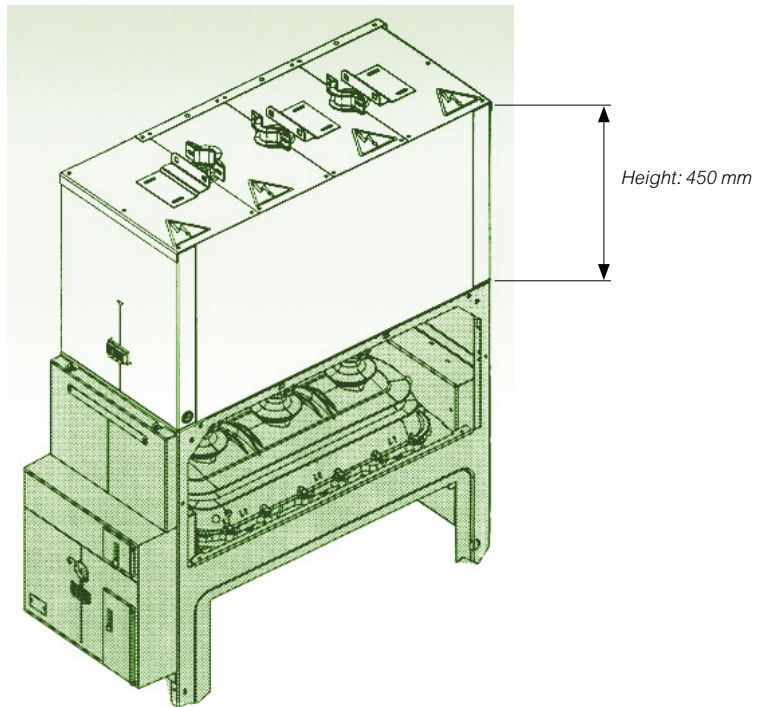

Installation

Installation

Dimensions and weights for SM6-24	132
Units dimensions for SM6-24	133
Civil engineering for SM6-24	137
Layout examples for SM6-24	138
Dimensions and weights for SM6-36	140
Civil engineering for SM6-36	141
Layout examples for SM6-36	142

Dimensions and weights for SM6-24

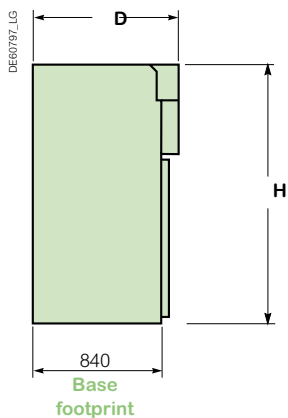

1. Add to height 450 mm for low-voltage enclosures for control/monitoring and protection functions. To ensure uniform presentation, all units (except GIM and GEM) may be equipped with low-voltage enclosures.
2. Depending on the busbar configuration in the VM6 unit, two types of extension units may be used:
 - To extend a VM6 DM12 or DM23 unit, use an extension unit with a depth of 1 060 mm
 - For all other VM6 units, a depth of 920 mm is required.
3. For the 1250 A unit.

Basic internal arc 12.5 kA 1s, IAC: A-FL

Dimensions and weights

Unit type	Height	Width	Depth	Weight
	H (mm)	(mm)	D (mm)	(kg)
IM,IMB	1600 ⁽¹⁾	375/500	940	120/130
IMM	1600	750	940	340
IMC	1600 ⁽¹⁾	500	940	200
PM, QM, QMB	1600 ⁽¹⁾	375/500	940	130/150
QMC	1600 ⁽¹⁾	625	940	180
CRM, CVM	2050	750	940	390
DM1-A, DM1-D, DM1-W, DM2, DMVL-A, DMVL-D, DM1-M	1600 ⁽¹⁾	750	1220	400
DM1-S	1600 ⁽¹⁾	750	1220	340
DMV-A, DMV-D	1695 ⁽¹⁾	625	940	340
CM	1600 ⁽¹⁾	375	940	190
CM2	1600 ⁽¹⁾	500	940	210
GBC-A, GBC-B	1600	750	1020	290
NSM-cables, NSM-busbars	2050	750	940	260
GIM	1600	125	840	30
GEM ⁽²⁾	1600	125	920/1060 ⁽²⁾	30/35 ⁽²⁾
GBM	1600	375	940	120
GAM2	1600	375	940	120
GAM	1600	500	1020	160
SM	1600 ⁽¹⁾	375/500 ⁽³⁾	940	120/150 ⁽³⁾
TM	1600	375	940	200
DM1-A, DM1-D, DM1-W, DM1-Z (1250 A)	1600	750	1220	420

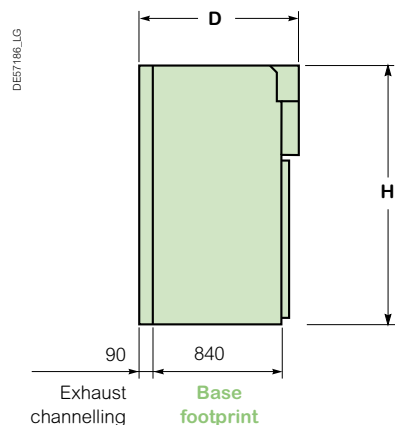

1. Add to height 450 mm for low-voltage enclosures for control/monitoring and protection functions. To ensure uniform presentation, all units (except GIM and GEM) may be equipped with low-voltage enclosures.
2. Depending on the busbar configuration in the VM6 unit, two types of extension units may be used:
 - To extend a VM6 DM12 or DM23 unit, use an extension unit with a depth of 1 060 mm
 - For all other VM6 units, a depth of 920 mm is required.
3. For the 1250 A unit.

Advance internal arc 12.5 kA 1s, IAC: A-FLR 16 and 20 kA 1s, IAC: A-FL/A-FLR

Dimensions and weights

Unit type	Height	Width	Depth	Weight
	H (mm)	(mm)	D (mm)	(kg)
IM,IMB	1600 ⁽¹⁾	375/500	1030	130/140
IMM	1600	750	1030	340
IMC	1600 ⁽¹⁾	500	1030	210
PM, QM, QMB	1600 ⁽¹⁾	375/500	1030	140/160
QMC	1600 ⁽¹⁾	625	1030	190
CVM	2050	750	1030	400
DM1-A, DM1-D, DM1-W, DM2, DMVL-A, DMVL-D, DM1-M	1600 ⁽¹⁾	750	1230	410
DM1-S	1600 ⁽¹⁾	750	1230	350
DMV-A, DMV-D	1695 ⁽¹⁾	625	1115	350
CM	1600 ⁽¹⁾	375	1030	200
CM2	1600 ⁽¹⁾	500	1030	220
GBC-A, GBC-B	1600 ⁽¹⁾	750	1030	300
NSM-cables, NSM-busbars	2050	750	1030	270
GIM	1600	125	930	40
GEM ⁽²⁾	1600	125	930/1060 ⁽²⁾	40/45
GBM	1600	375	1030	130
GAM2	1600	375	1030	130
GAM	1600	500	1030	170
SM	1600 ⁽¹⁾	375/500 ⁽³⁾	1030	130/160
TM	1600	375	1030	210
DM1-A, DM1-D, DM1-W, DM1-Z (1250 A)	1600 ⁽¹⁾	750	1230	430

Basic internal arc 12.5 kA 1s, IAC: A-FL

IM, IMB, PM, QM, QMB, SM, IMC, QMC, CM, CM2

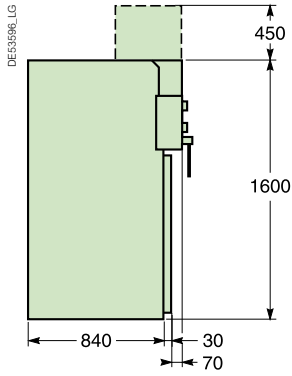

NSM-cables, NSM-busbars, CRM, CVM

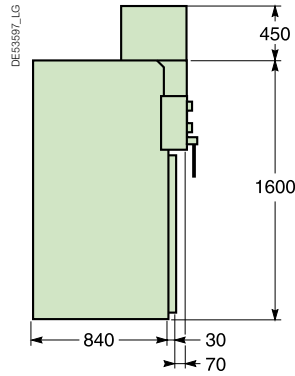

GBM, GAM2

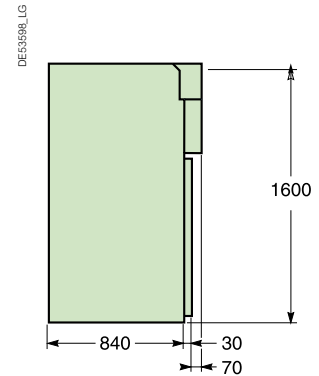

GAM

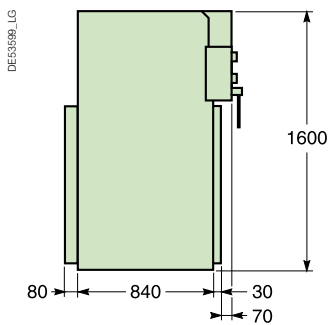

GIM

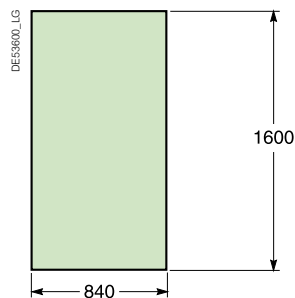

GEM

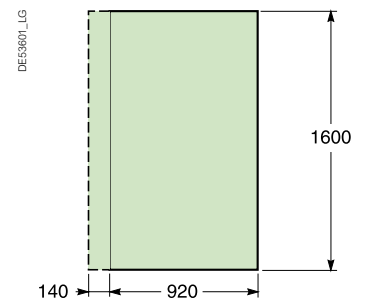

GBC-A, GBC-B, IMM

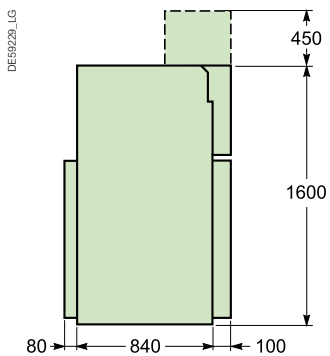

EMB

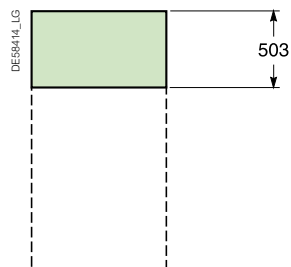

Basic internal arc 12.5 kA 1s, IAC: A-FL

DMVL-A, DMVL-D, DM1-A, DM1-D, DM1-W, DM1-Z, DM1-S, DM2 630 A, DM1-M

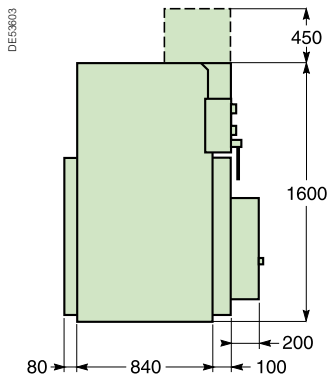

DM1-A, DM1-W 1250 A

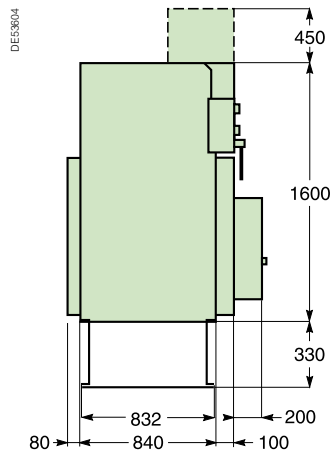

DMV-A 1250 A

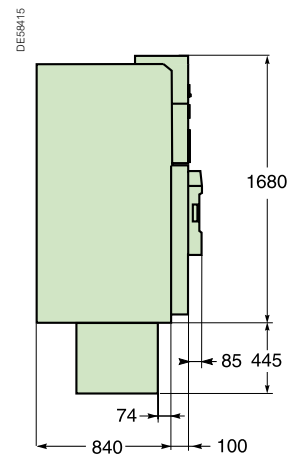

DMV-A 630 A

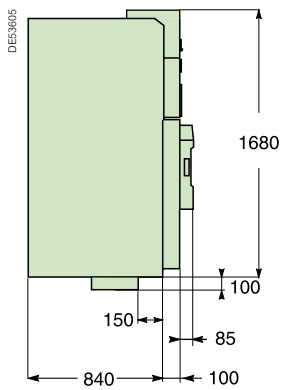

DMV-D

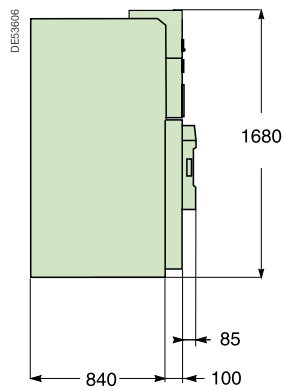

Units dimensions for SM6-24

Advance internal arc 12.5 kA 1s, IAC: A-FLR, 16 and 20 kA 1s, IAC: A-FL/A-FLR

IM, IMB, PM, QM, QMB, SM, IMC, QMC, CM, CM2

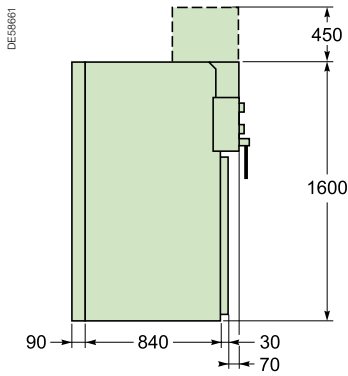

NSM-cables, NSM-busbars, CVM

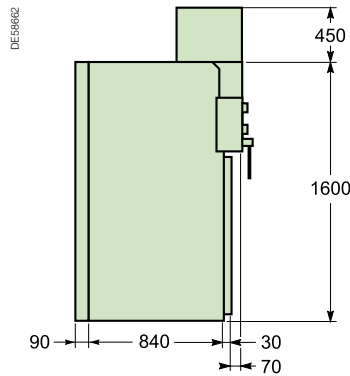

GBM, GAM2

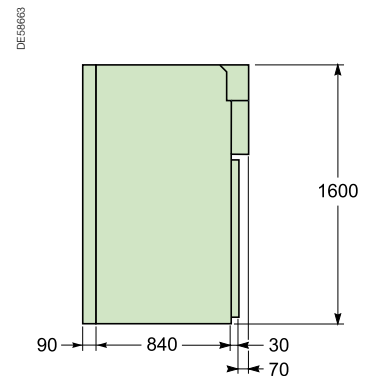

GAM

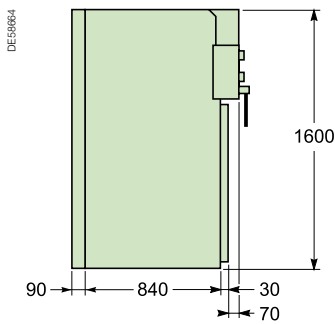

GIM

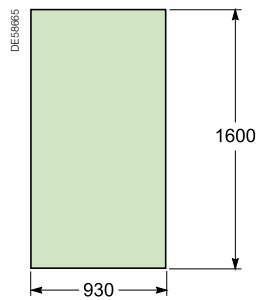

GEM

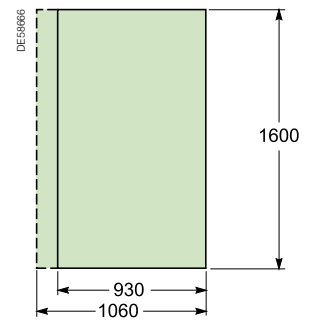

GBC-A, GBC-B, IMM

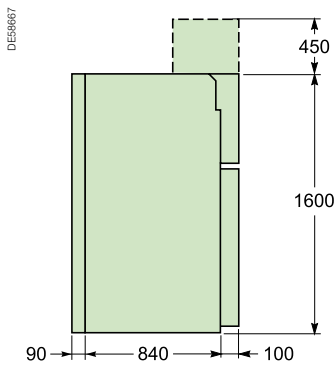

IM with EMB option

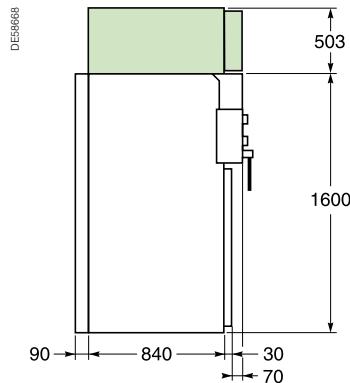

Units dimensions for SM6-24

Advance internal arc 12.5 kA 1s, IAC: A-FLR,
16 and 20 kA 1s, IAC: A-FL/A-FLR

**DMVL-A, DMVL-D, DM1-A, DM1-D, DM1-W, DM1-Z,
DM1-S, DM2 630 A, DM1-M**

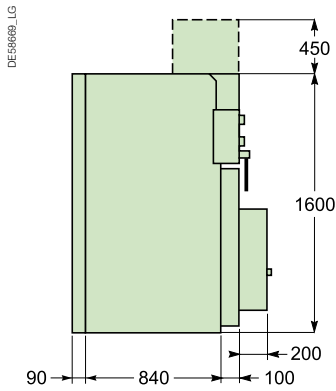

DM1-A 630 A with EMB option

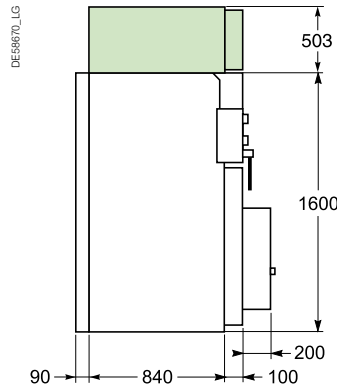

DM1-A, DM1-W 1250 A

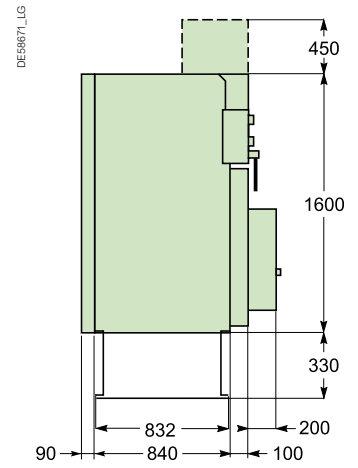

DMV-A 630 A

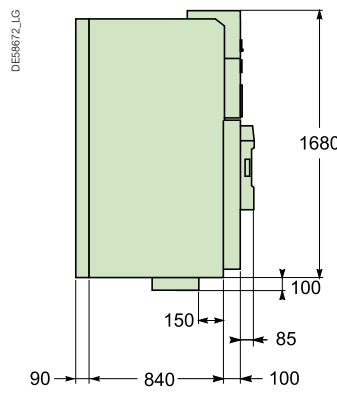

DMV-A 1250 A

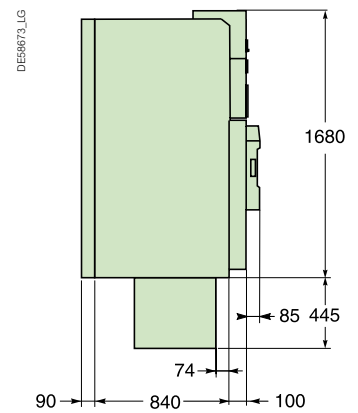

DMV-D

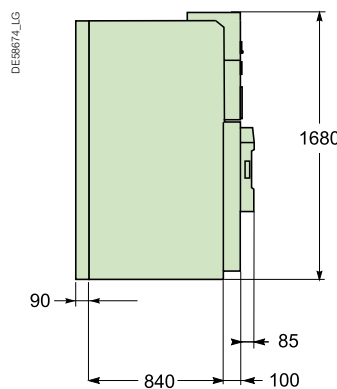

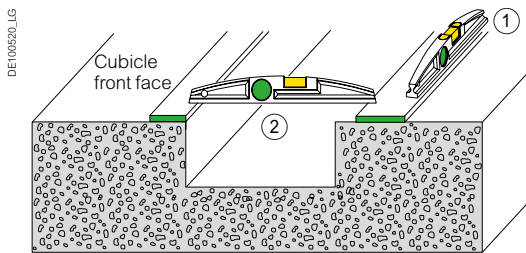

Ground preparation

To obtain the internal arc performance, ground implementation must comply with the following requirements:

- Straightness: 2 mm / 3 m (Rep.1)
- Flatness: 3 mm maximum (Rep.2)

All the elements allowing the evacuation of the gas (duct, casing, etc.) must be able to bear a load of 250 kg/m².

Fixing of units

With each other

The units are simply bolted together to form the MV switchboard (bolts supplied). Busbar connections are made using a torque wrench set to 28 mN.

On the ground

- For switchboards comprising up to three units, the four corners of the switchboard must be secured to the ground with using:
 - M8 bolts (not supplied) screwed into nuts set into the ground using a sealing pistol
 - Screw rods grouted into the ground
- For switchboards comprising more than three units, each unit may be fixed to the ground
- In circuit-breaker or contactor units, fixing devices are installed on the opposite side of the switchgear.

See details in "Installation Condition" 7897512EN and S1B70396

Position of cubicles in a substation

Installation of a switchboard classified IAC 12.5 kA 1s: A-FL
Conventional substation (Masonry)

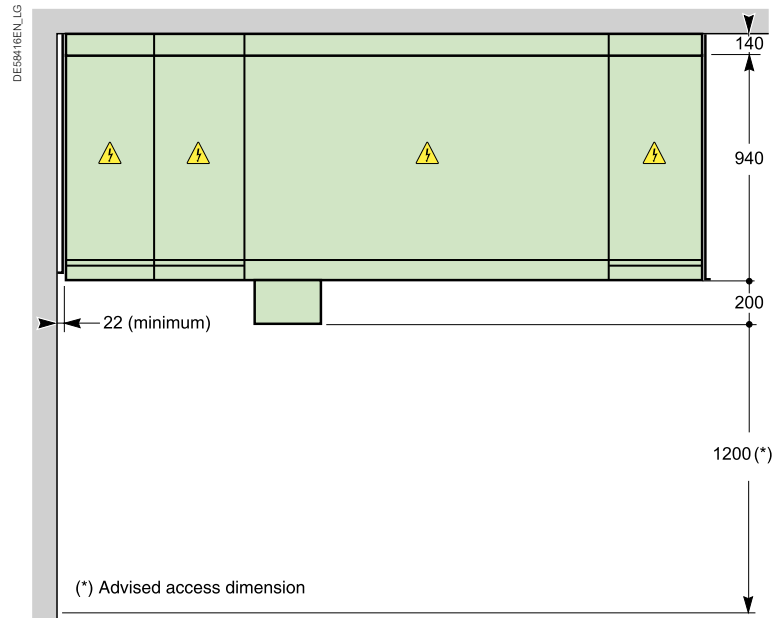

Installation of a switchboard classified IAC 16/20 kA 1s: A-FL
with downwards exhaust

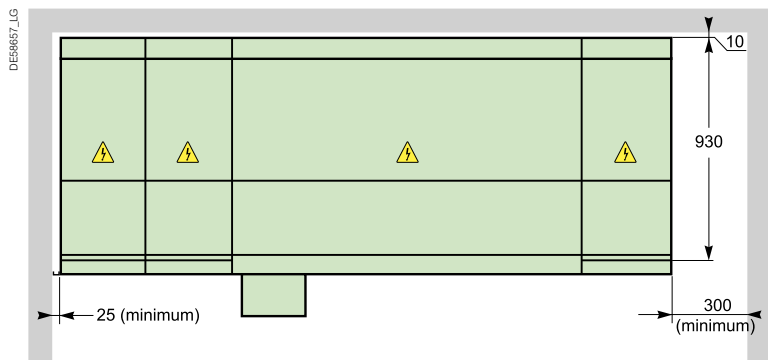

300 mm minimum required for human access for fixation of the back during installation.

Installation of a switchboard classified IAC: A-FLR
with downwards exhaust

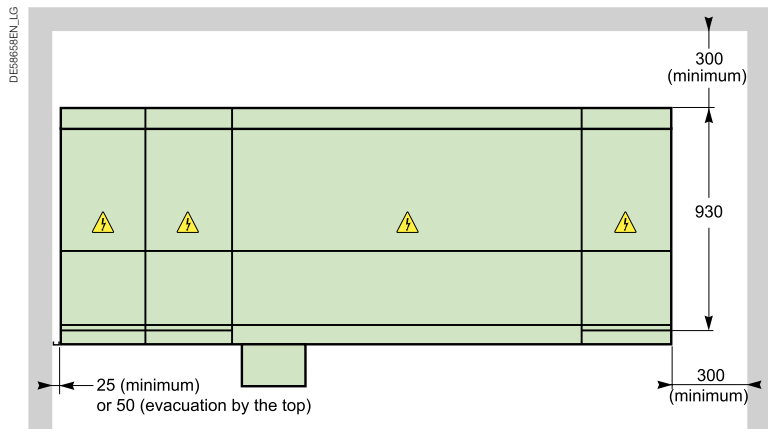

300 mm minimum required for human access for fixation of the back during installation.

Layout examples for SM6-24

Installation of a switchboard classified IAC: A-FL & A-FLR with upwards exhaust left side

(ceiling height \geq 2150 mm)

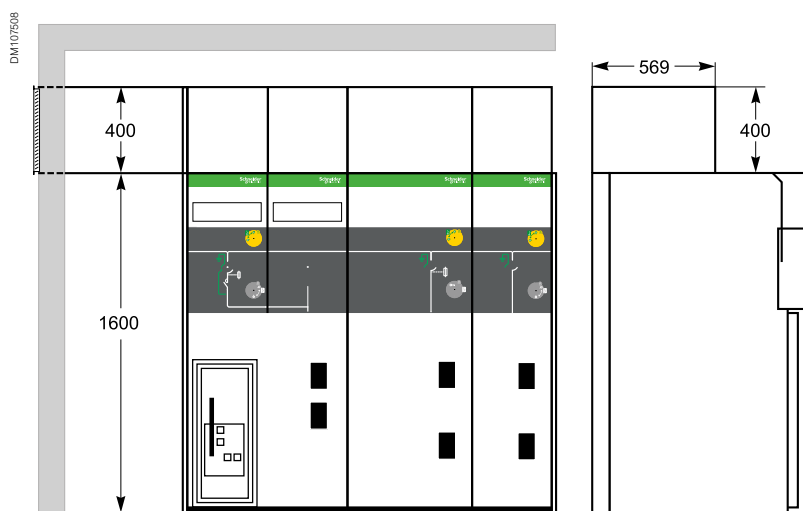

Gas exhaust duct

To enable the evacuation of gases by the top, users must install a duct fixed to the coupling flange on the right or left of the switchboard. For IP3X protection, a flap must be installed with this coupling flange on the lateral of the cubicle duct.

The end of the duct must block water, dust, moisture, and animals from entering and at the same time enable the evacuation of gases into a dedicated area through a device situated at the outer end of the duct (not supplied).

Gas exhaust duct

example:
The exhaust duct must be made of metal sheet of sufficient thickness to withstand pressure and hot gases.

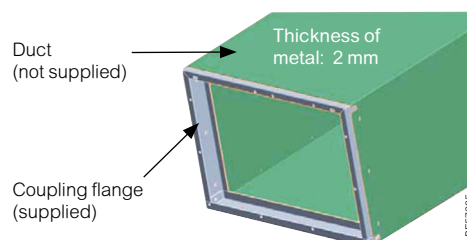

Dimensions and weights for SM6-36

Dimensions and weights

Unit type	Height H (mm)	Width (mm)	Depth D (mm)	Weight (kg)
IM, SM	2250	750	1400 ⁽³⁾	310
IMC, IMB	2250	750	1400 ⁽²⁾	420
QM, PM, QMB	2250	750	1400 ⁽³⁾	330
QMC	2250	1000	1400 ⁽³⁾	420
DM1-A	2250	1000	1400 ⁽²⁾	600
DM1-D	2250	1000	1400 ⁽²⁾	560
GIM	2250	250	1400	90
DM2	2250	1500	1400 ⁽²⁾	900
CM, CM2	2250	750	1400 ⁽²⁾	460
GBC-A, GBC-B	2250	750	1400 ⁽³⁾	420
GBM	2250	750	1400 ⁽³⁾	260
GAM2	2250	750	1400 ⁽³⁾	250
GAM	2250	750	1400 ⁽³⁾	295

(1) The depth measures are given for the floor surface.

(2) The depth in these units are 1615 mm with the enlarged low voltage compartment.

(3) The depth in these units are 1500 mm with the standard low voltage compartment.

IM, SM, IMC, QM, PM, IMB, GBM, GAM, GAM2, GBC-A, GBC-B, QMB, QMC units

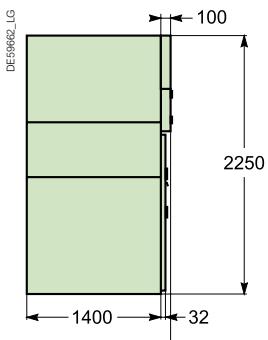

CM, CM2 units

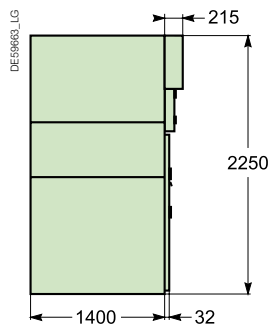

DM1-A, DM1-D, DM2 units

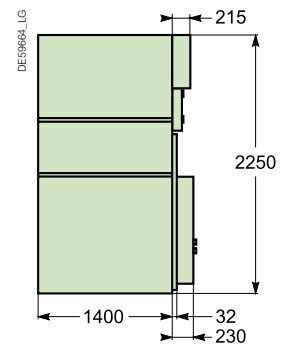

Ground preparation

Units may be installed on ordinary concrete grounds, with or without trenches depending on the type and cross-section of cables.

Required civil works are identical for all units.

Fixing of units

With each other

The units are simply bolted together to form the MV switchboard (bolts supplied). Busbar connections are made using a torque wrench set to 28 mN.

On the ground

- For switchboards comprising up to three units, the four corners of the switchboard must be secured to the ground with using:
 - M8 bolts (not supplied) screwed into nuts set into the ground using a sealing pistol
 - Screw rods grouted into the ground
- For switchboards comprising more than three units, each unit may be fixed to the ground
- In circuit-breaker or contactor units, fixing devices are installed on the opposite side of the switchgear.

See details in "Installation Condition" 7897512EN and S1B70396

See "Installation Condition" EAV4899801

Conventional substation (Masonry)

Top view

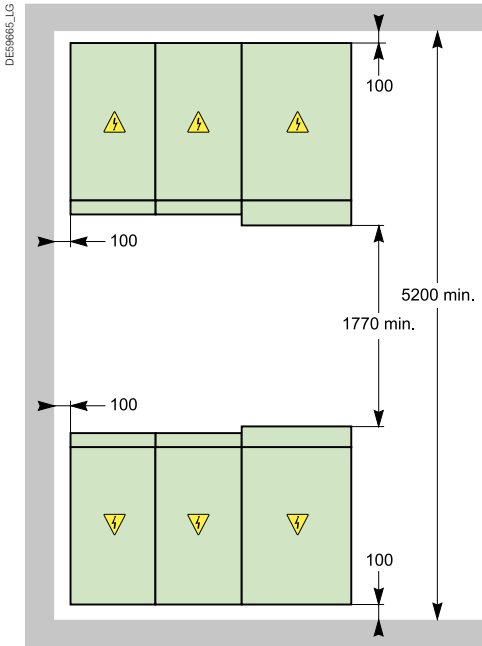

Side view

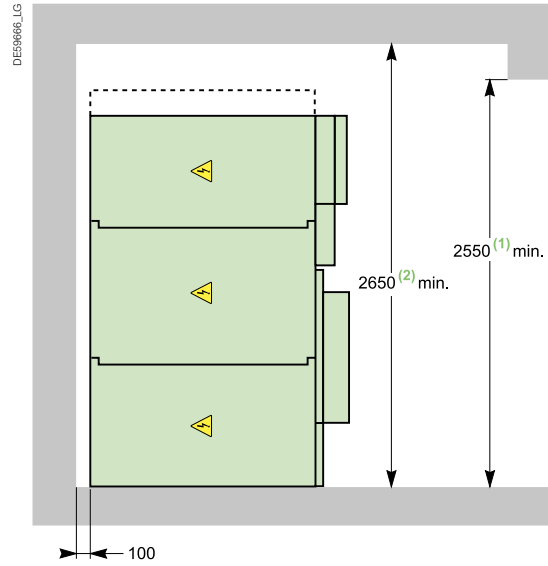

Minimum required dimensions (mm)

(1) In case of upper incoming option: it must be 2730 mm (no internal arc withstand performance available)

(2) In case of upper incoming option: it must be 2830 mm (no internal arc withstand performance available)

Top view

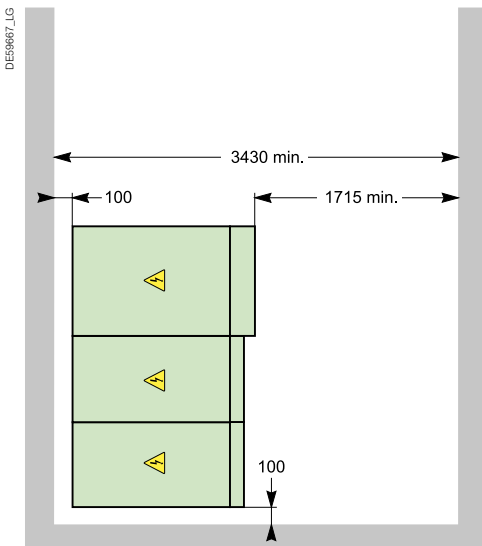

Notes

Schneider Electric services

Schneider Electric services

ProDiag Breaker	146
Diagnosis of MV and LV Circuit Breakers	146

ProDiag Corona	147
Diagnostics of partial discharges	147

ProDiag Fuse	148
Proprietary and standards diagnostics tools	148

ProDiag Breaker

Diagnosis of MV and LV Circuit Breakers

PE60531



What is ProDiag Breaker?

ProDiag Breaker is a Schneider Electric diagnosis tool which compares the mechanical and electrical parameters measured during the full operation of circuit breakers with the data collected from our production facilities. This allows detecting possible failure in advance. It measures, records and displays on a screen the key electrical parameters in MV and LV circuit breakers, relating to opening, closing and springloading operations.

All this data is automatically compared with the criteria for the circuit breaker designated in the software, which indicates which values are within the acceptable range, which are on the limit and which are outside it.

Two tests are always performed on each circuit breakers, one at minimum voltage and one at nominal voltage. A written report is generated and provided by Schneider Electric so that the customer can use it as a tool to define the necessary corrective action (maintenance, repair or replacement).

ProDiag Breaker is part of ProDiag preventive maintenance plan

Evaluation of circuit breakers using ProDiag Breaker includes:

- Evaluation of the operating mechanism.
- Measurement and comparison of the actual contact resistance with that specified by the manufacturer.
- Measurement and comparison of the insulation resistance.
- Evaluation of the general circuit breaker conditions based on the captured data.

Moreover, analysis of the ProDiag Breaker time/ travel curve combined with the current curve of the coil and phase contact detects possible faults, such as:

- Worn out latches and operating mechanisms.
- Faulty coils.
- Mechanical wear and tear and hardening of lubricating grease.
- Defective shock absorbers.
- Defective simultaneous contact operation (opening/closing).

Some maintenance programmes involve dismantling the circuit breaker mechanism to check its condition. ProDiag Breaker using signals captured from the circuit breaker operation, reduces maintenance costs compared with programs which check the circuit breakers manually.

ProDiag Breaker Objectives

Your priority is to enhance the reliability of your installation:

- to ensure its continuity of service,
- to minimize the time for maintenance & repair
- to perform maintenance
- Only on the equipment requiring it and only when necessary (conditional preventive maintenance)

Results

ProDiag Breaker provides a report of the complete nature of the circuit breaker, detailing: closing / opening time, contact simultaneity, bounce and resistance, mechanical closing and opening forces.

This report enables any required maintenance to be targeted and time in order to optimize the customer's maintenance plan.

Where can ProDiag Breaker reduce costs?

- ProDiag Breaker significantly reduces the time taken to identify potential faults in a circuit breaker, using operational analysis rather than inspection and mechanical re-sets.
- The software analyses the captured data and identifies the specific problem area.
- A device's normal operating life is increased by timely diagnostics of when and what repairs are necessary.
- The tool comprises both hardware and software, resulting in a highly efficient predictive maintenance program.

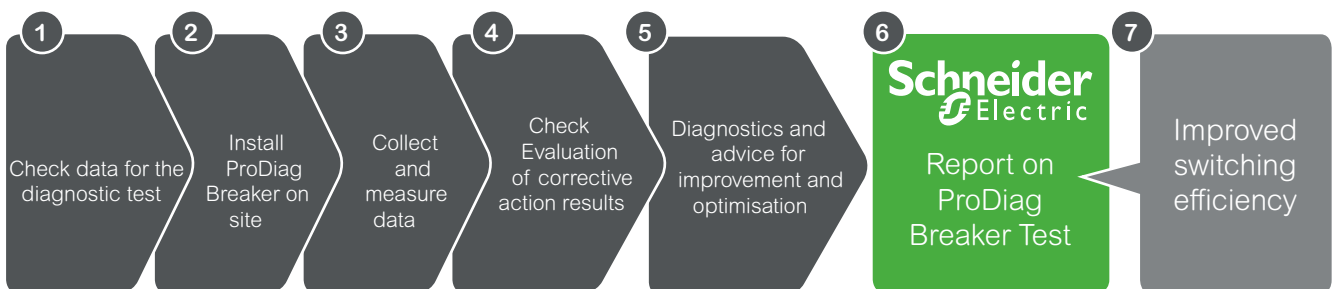

ProDiag Corona

Diagnostics of partial discharges

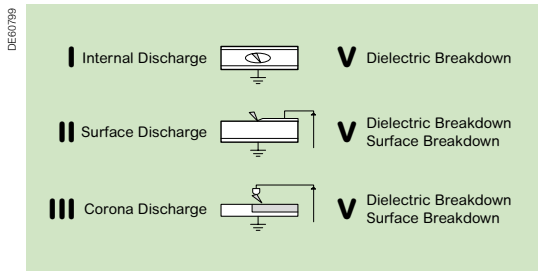

ProDiag Corona objectives

Your priority is to have fast Electrical equipment inspection without shutdown

Safety (Human Life and asset)

- Enhance the reliability of your installation
- Optimisation of installation life duration & costs

Risks prevention from:

- Partial discharges and internal arc
- Dielectric degradation
- Electrical Fire

What is ProDiag Corona?

ProDiag Corona is a Schneider Electric diagnosis tool.

ProDiag Corona detects partial discharges in Medium Voltage cubicles.

- Partial Discharge occurs across part of the insulation between two conducting electrodes, without completely bridging the gap.
- Partial discharge can happen under normal working conditions as a result of insulation breakdown due to premature aging caused by thermal or electrical over-stressing of the high voltage system.

ProDiag Corona analyses the primary electrical signal through VIS (Voltage Indicator System) fixed on the switchboards. Measurements are taken by

an electronic sensor and the data is transmitted to the ProDiag Corona software in order to evaluate the level of criticality of the controlled equipment.

A written report is generated, which will be handed over by Schneider Electric so that the customer can use it as a tool to define the necessary corrective action, whether maintenance, repair or replacement.

ProDiag Corona is not a certification tool.

ProDiag Corona executes the assessment of the energized equipment, without any shutdown and then without disruption for the users.

This system allows you to control all types of the most common partial discharges:

- Internal partial discharges
- Surface partial discharge
- Corona effect

ProDiag Corona diagnostic can be realized on most Medium Voltage equipment on the market equipped with VIS.

Where can ProDiag Corona reduce costs?

ProDiag Corona significantly reduces the time taken to identify potential faults in a switch, without electrical shutdown.

A device's normal operating life is increased by timely diagnostics of when and what repairs are necessary. ProDiag Corona is a trouble shooting anticipation tool which can avoid internal arc risks and untimely tripping.

- The tool comprises both hardware and software, resulting in a highly efficient preventive maintenance program.

Results

ProDiag Corona provides a report of the complete electrical room, detailing: ventilation, air filtration, due point calculation, level of criticability of each set of equipment, constructor recommendations on any potential maintenance, repair & rehabilitation.

This report enables any required maintenance to be targeted and timed to optimize the customer's maintenance plan.

ProDiag Corona is performed thanks to XDP2 testing equipment from NDB technology.

ProDiag Fuse

Proprietary and standards diagnostics tools

PE60532



PE60533



Customer needs

Electrical power installations protected by MV switchgear with fuse protection should be regularly checked (for correct assembly, electrical parameters, etc.) to confirm that their characteristics correspond to the original specification. Regular diagnosis of fuse performance (electrical parameters, resistance) according to the manufacturer's recommendations is necessary to secure the ED installation and its service continuity, which are important for customers.

The ProDiag Fuse diagnostic solution can be used on MV switchgear protected by fuses that have not received any maintenance intervention in the last four years (under normal operating conditions, and less if operating in severe environments or depending on their criticality in the installation).

The purpose of ProDiag Fuse (a proprietary hardware-software solution) is to mitigate the risks on MV switchgear and equipment by fuses of faults or drifts causing unwanted effects. The result of fuse ageing is the destruction of filaments that can lead to thermal runaway, partial damage, complete destruction of MV switchgear and equipment, or even destruction of the electrical room.

"Unique value for customer vs standard market tools"

Electrical parameter measurements (resistance, etc.) on MV switchgear fuses at customer sites are taken by a test tool and transmitted to the Schneider Electric FSRs' ProDiag Fuse software. Data are compared to those of a fuse manufacturers' technical database.

The aim is to determine whether recorded measurements are within the acceptable range, at the limit, or fall outside it, as criteria for MV switchgear fuse conformity.

As an ED equipment manufacturer, Schneider Electric is uniquely positioned to develop and invest in specific tests tools, proprietary software, and testing methodology to collect reliable measurements from MV switchgears fuses.

ProDiag Fuse measures a larger number of parameters than standard market tools. It delivers best-in-class MV switchgear fuse diagnostics.

Schneider Electric scope: Schneider Electric fuses and main market fuses players.

Customer benefits

ProDiag Fuse helps customers visualise, discover, and understand MV switchgear fuse ageing and wear and tear as compared to the original fuse manufacturers' technical specification.

ProDiag Fuse monitors the performance of MV switchgear fuses.

Thanks to **ProDiag Fuse**, maintenance managers can implement, manage, and enrich their maintenance plans. Schneider Electric FSRs conclude their on-site interventions with an exhaustive report on the MV switchgear fuses conformity/non-conformity. If a MV fuse is declared non-conforming, Schneider Electric suggests a corrective plan that includes fuse replacement to regain original performance in safety and service continuity.

Customers can augment their preventive maintenance plans with this corrective action at the most convenient time for each ED device.

Notes

Appendices and Order Form

Appendices and Order form

Appendices

VIP tripping curves	152
VIP 40 and VIP 45 tripping curve	152
VIP 400 tripping curves	153
VIP 410 tripping curves	155
<hr/>	
Fusarc CF fuses	156
<hr/>	
Solefuse fuses	157
<hr/>	

Order form

SM6 switching	158
Switching	158
Automatic Transfer System	160
<hr/>	
SM6 protection	162
Circuit breaker	162
Fuse switch	165
<hr/>	
SM6 metering	169
<hr/>	
SM6 other functions	171
<hr/>	
SF1 lateral / frontal fixed	172
<hr/>	
SFset	173
Lateral / frontal fixed	173
Lateral disconnectable for SM6-24	174
<hr/>	
Evolis	175
Frontal fixed version for SM6-24 (up to 17.5 kV)	175
Lateral disconnectable version for SM6-24 (up to 24 kV)	176
<hr/>	

VIP tripping curves

VIP 40 and VIP 45 tripping curve

Phase overcurrent protection (ANSI 50-51)

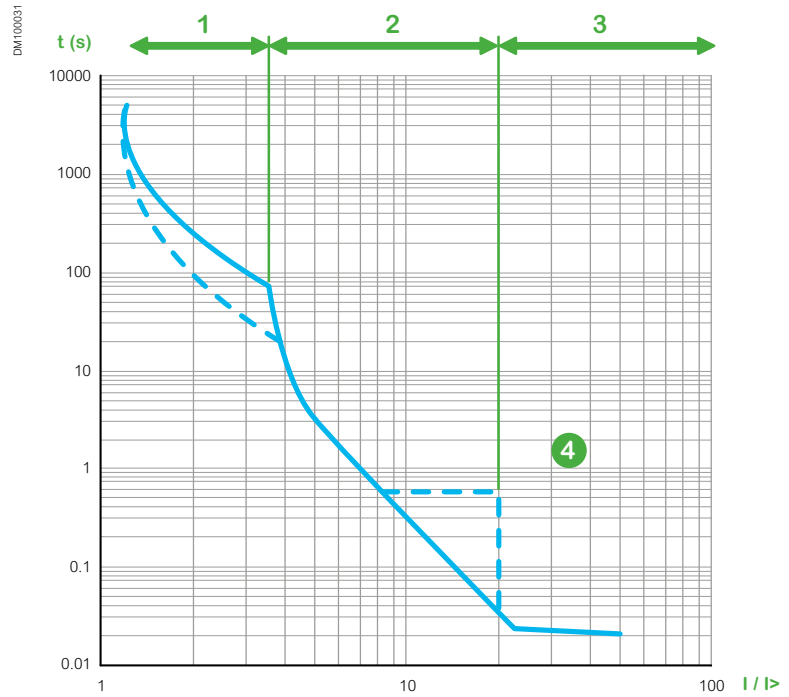

1. Overload
2. Secondary short-circuit
3. Primary short-circuit
4. Activation of discrimination with a Low Voltage circuit breaker

VIP tripping curves

VIP 400 tripping curves

IEC Standard Inverse Time Curve
(IEC/SIT or IEC/A)

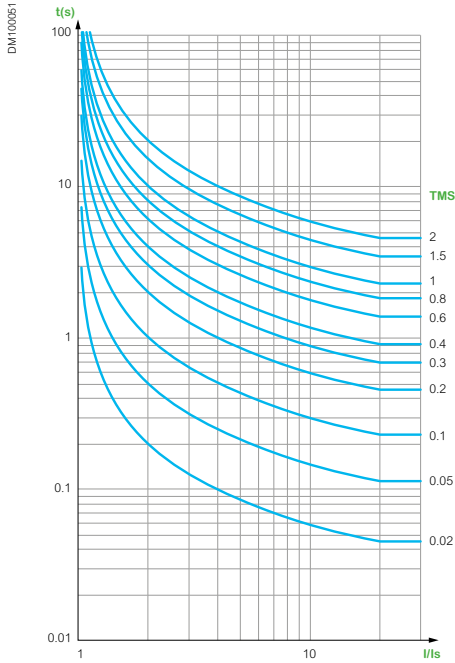

IEC Very Inverse Time Curve
(IEC/VIT or IEC/B)

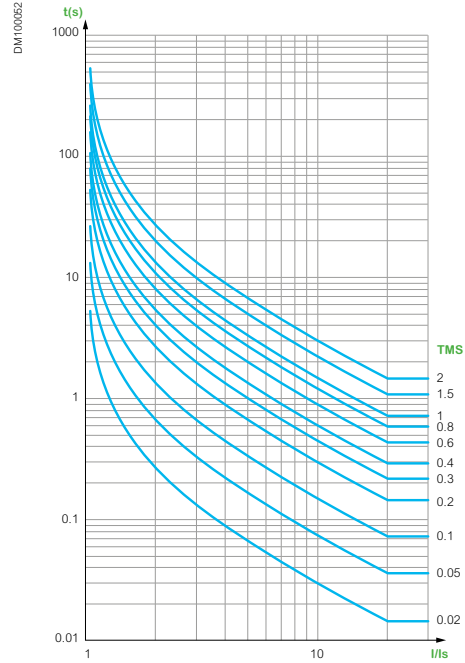

IEC Long Time Inverse Curve
(IEC/LTI)

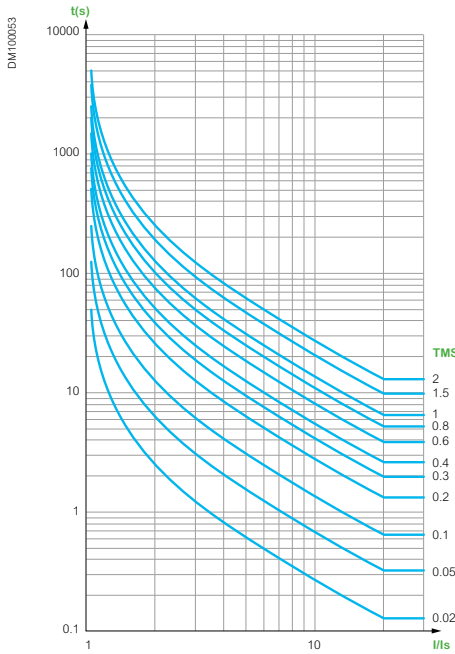

IEC Extremely Inverse Time Curve
(IEC/EIT or IEC/C)

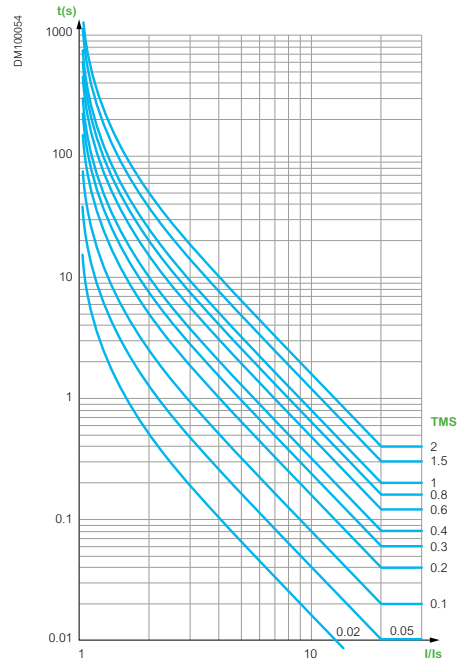

VIP tripping curves

VIP 400 tripping curves

IEEE Moderately Inverse Curve
(IEEE/MI or IEC/D)

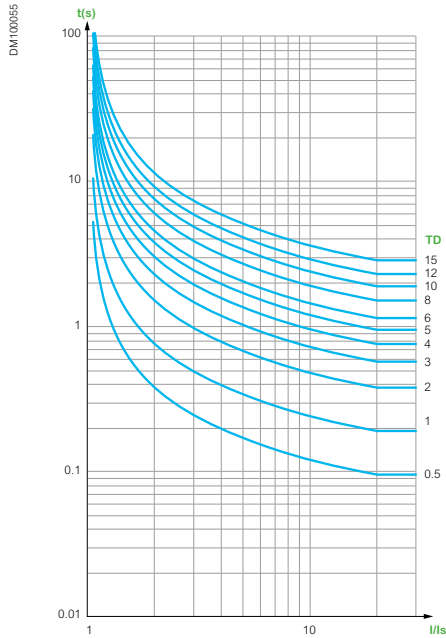

IEEE Very Inverse Curve
(IEEE/VI or IEC/E)

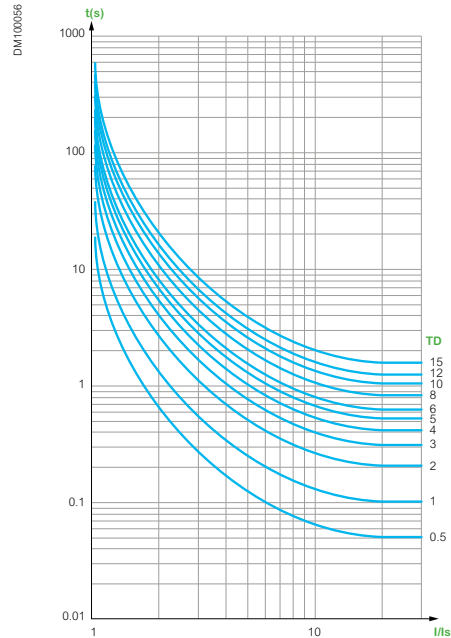

IEEE Extremely Inverse Curve
(IEEE/EI or IEC/F)

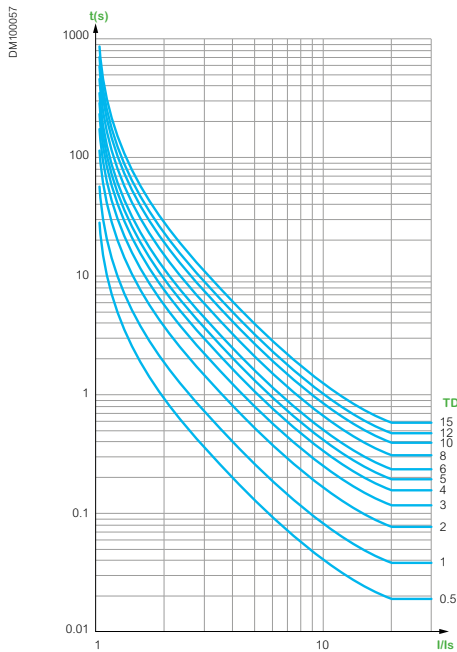

RI Curve

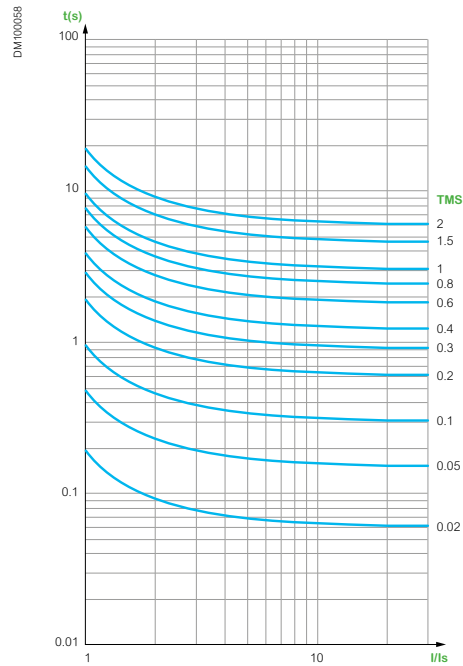

VIP tripping curves

VIP 410 tripping curves

IEEE Moderately Inverse Curve
(IEEE/MI or IEC/D)

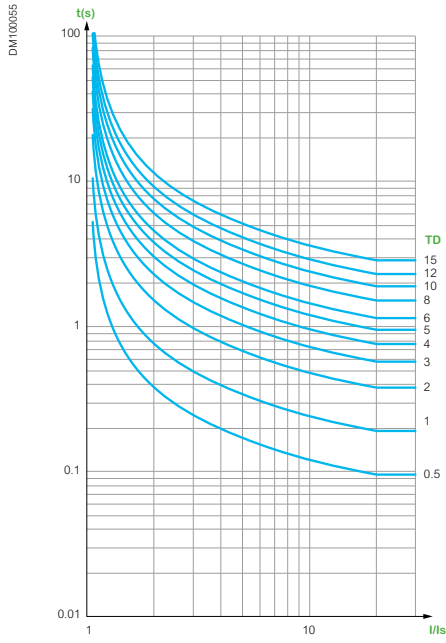

IEEE Very Inverse Curve
(IEEE/VI or IEC/E)

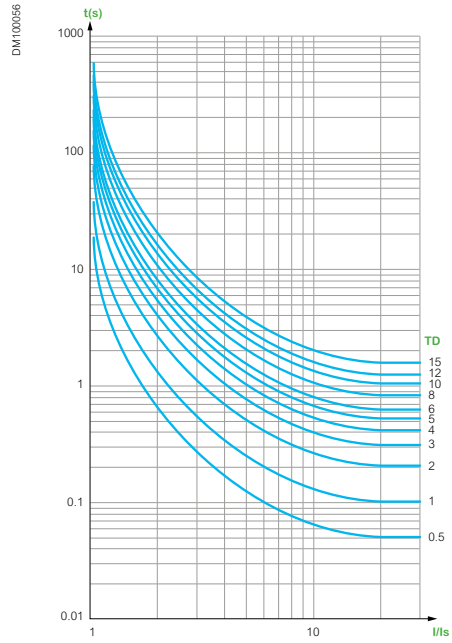

IEEE Extremely Inverse Curve
(IEEE/EI or IEC/F)

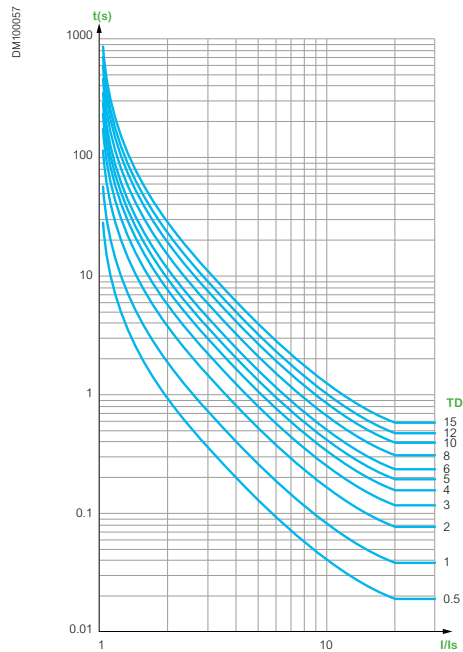

RI Curve

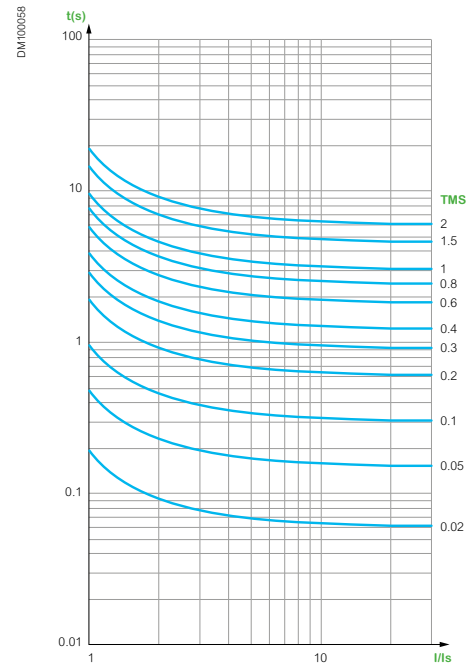

Fusarc CF fuses

Fuse and limitation curves

Fuse curve

3.6 - 7.2 - 12 - 17.5 - 24 - 36 kV

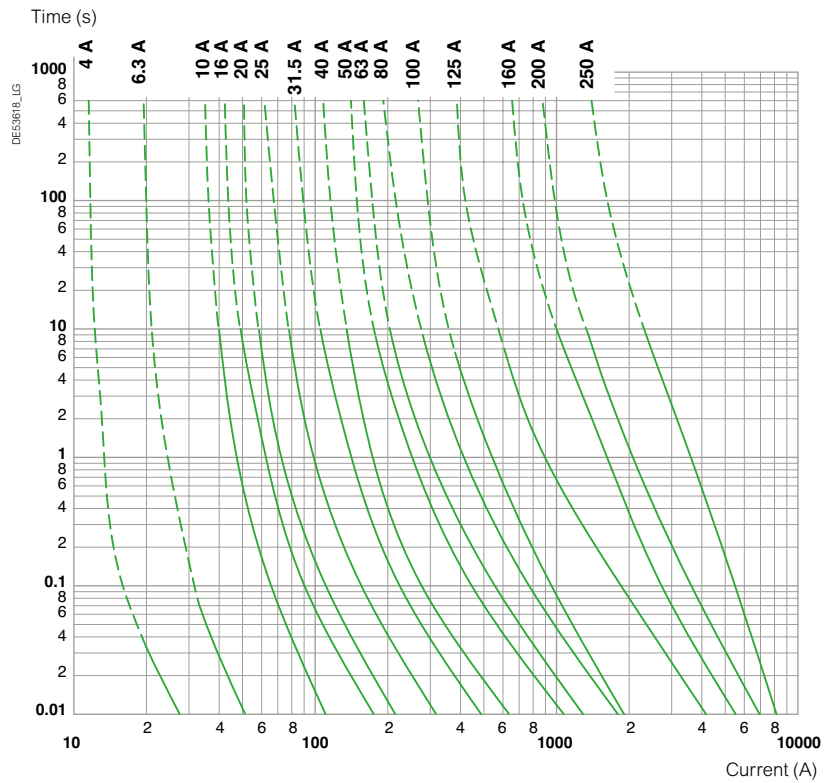

Limitation curve

3.6 - 7.2 - 12 - 17.5 - 24 - 36 kV

The diagram shows the maximum limited broken current value as a function of the rms current value which could have occurred in the absence of a fuse.

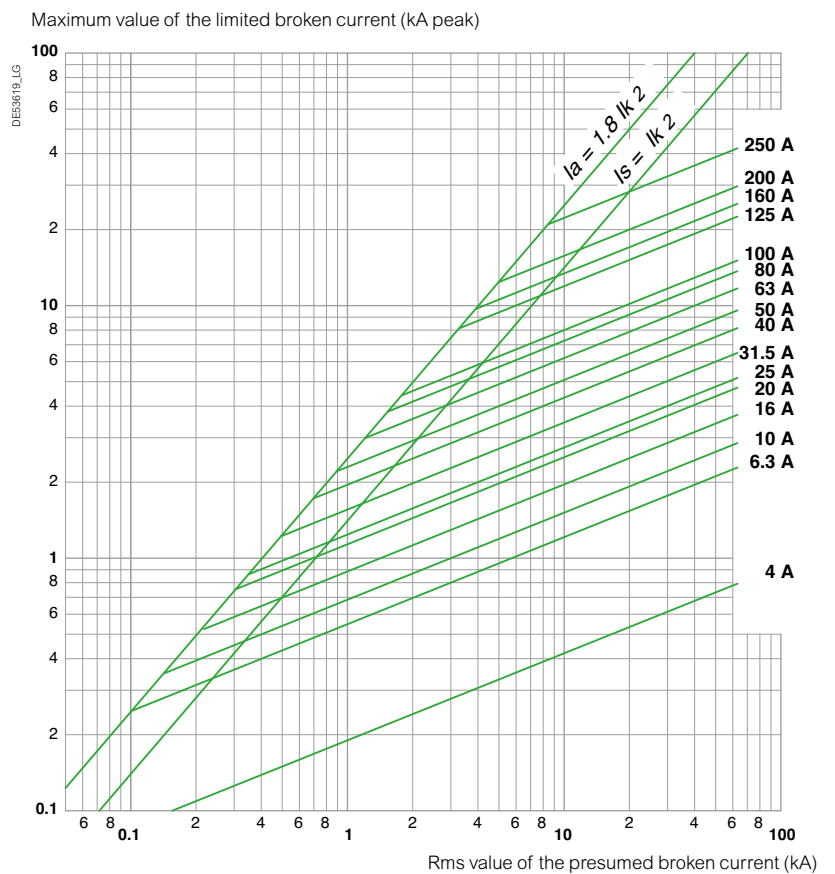

Solefuse fuses

Fuse and limitation curves

Fuse curve 7.2 - 12 - 17.5 - 24 kV

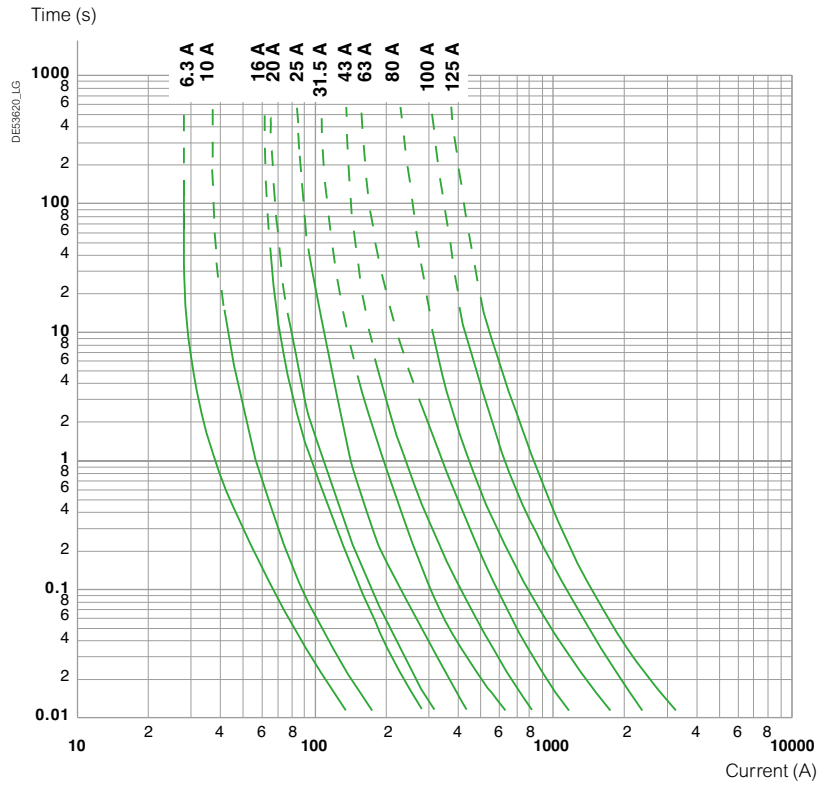

Limitation curve 7.2 - 12 - 17.5 - 24 kV

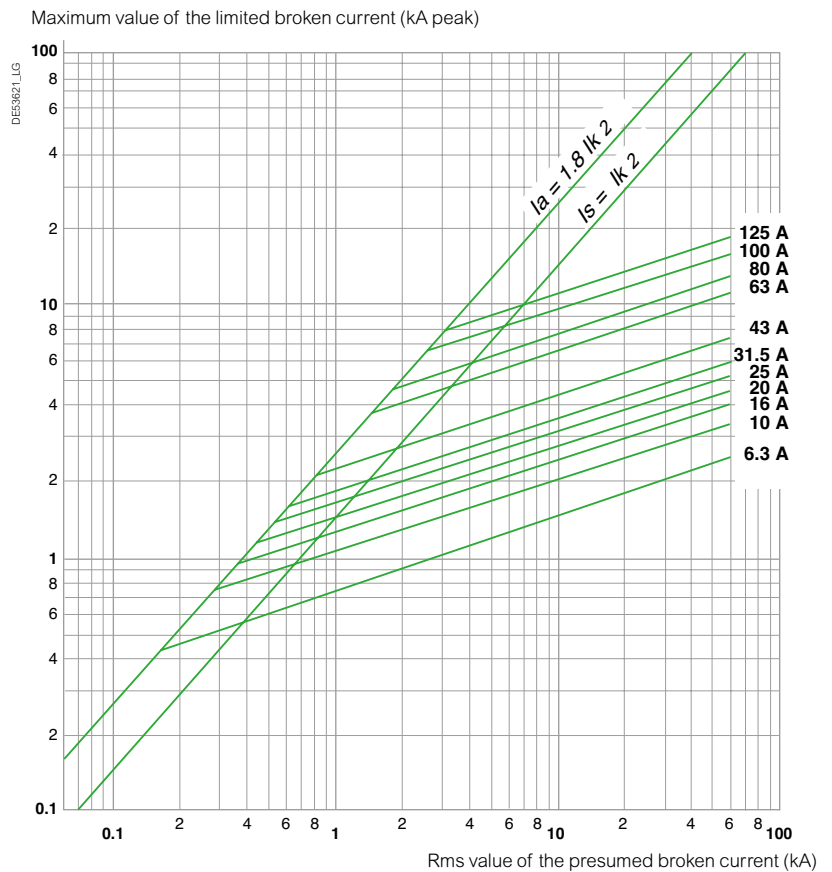



The diagram shows the maximum limited broken current value as a function of the rms current value which could have occurred in the absence of a fuse.



SM6 switching

Switching

Basic cubicle / Common options

Only one of the boxes
 - ticked
 - or filled
 by the needed value
 have to be considered
 between each
 horizontal line.

Basic cubicle		Quantity
Rated voltage Ur		(kV) <input type="text"/>
Service voltage		(kV) <input type="text"/>
Short-circuit current Isc		(kA) <input type="text"/>
Rated current Ir		(A) <input type="text"/>
Internal arc withstand	12.5 kA 1s for SM6-24 <input type="checkbox"/>	16 kA 1s for SM6-36 <input type="checkbox"/>
Internal arc classification	A-FL	
Gaz exhaust direction	Downwards	
Type of cubicle		
24 kV	SM 375 <input type="checkbox"/>	IM 375 <input type="checkbox"/> IMC 500 <input type="checkbox"/> IMB 375 <input type="checkbox"/>
	SM 500 (for 1250 A) <input type="checkbox"/>	IM 500 <input type="checkbox"/> IMM <input type="checkbox"/> A-FL
36 kV	SM 750 <input type="checkbox"/>	IM 750 <input type="checkbox"/> IMC 750 <input type="checkbox"/> IMB 750 <input type="checkbox"/>
Position in the switchboard	First on left <input type="checkbox"/>	Middle <input type="checkbox"/> Last on right <input type="checkbox"/>
Direction of lower busbars for IMB	Left (impossible as first cubicle of switchboard)  <input type="checkbox"/>	Right  <input type="checkbox"/>
Cable connection by the bottom (1x single core, cable maximum 240 mm ²)	36 kV <input type="checkbox"/>	

Common options	
Replacement of CIT by	C11 <input type="checkbox"/> C12 <input type="checkbox"/>
Motorization	Standard <input type="checkbox"/> SM-24 Severe and communication <input type="checkbox"/>
Ambient monitoring	SM-24 <input type="checkbox"/>
Arc detection	IM cubicle <input type="checkbox"/>
Electrical driving motorization and/or coil voltage (not applicable on SM cubicle)	24 Vdc <input type="checkbox"/> 110 Vdc <input type="checkbox"/> 120/127 Vac (50 Hz) <input type="checkbox"/>
	32 Vdc <input type="checkbox"/> 120-125 Vdc <input type="checkbox"/> 220/230 Vac (50 Hz) <input type="checkbox"/>
	48 Vdc <input type="checkbox"/> 137 Vdc <input type="checkbox"/> 120/127 Vac (60 Hz) <input type="checkbox"/>
	60 Vdc <input type="checkbox"/> 220 Vdc <input type="checkbox"/> 220/230 Vac (60 Hz) <input type="checkbox"/>
Signalling contact	1 C on SW and 1 O & 1 C on ES (not applicable on SM cubicle) <input type="checkbox"/> 2 O & 2 C on SW <input type="checkbox"/> 2 O & 3 C on SW and 1 O & 1 C on ES <input type="checkbox"/>
Interlocking	Tubular key type  <input type="checkbox"/> Flat key type  <input type="checkbox"/>
	For all cubicles (except SM) A4 <input type="checkbox"/> A3 SM6-SM6 <input type="checkbox"/> P1 SM6-SM6 <input type="checkbox"/>
	Localisation of 2nd lock for A3 On switch <input type="checkbox"/> On earthing switch <input type="checkbox"/>
	Localisation of 2nd lock for A4 SM cubicle only P2 SM6-SM6 <input type="checkbox"/> Cubicle no. <input type="text"/> P3 SM6-SM6 <input type="checkbox"/>
Digital ammeter or fault current indicator	AMP 21D <input type="checkbox"/> Flair 23DV zero sequence <input type="checkbox"/>
	Flair 21D <input type="checkbox"/> Flair 22D <input type="checkbox"/> Flair 23DM <input type="checkbox"/>
Visibility of main contacts	Analogic manometer with visibility of main contacts <input type="checkbox"/>
Pressure indicator device	Pressure switch <input type="checkbox"/> Analogic manometer without visibility of main contacts <input type="checkbox"/>

SM6 switching

Switching

Options

Only one of the boxes

- ticked

- or filled

by the needed value
have to be considered
between each
horizontal line.

SM6-24 options

Remote control signalling

Voltage of the lights (must be the same than electrical driving mechanism)

2 lights

2 lights and 2 PB

2 lights and 2 PB + 1 switch

Roof configuration (A, B or C only one choice possible)

A - Cable connection by the top (cable maxi 240 mm² with VPIS)

Single core

2 x single core

B - Low voltage control cabinet (h = 450 mm)

With unpunched door

C - Wiring duct

Cable connection by the bottom
(not applicable on IMB, cable maxi 240 mm²)

Three core

Single core

2x single core

50 W heating element

Surge arresters for IM 500

7.2 kV

10 kV

12 kV

17.5 kV

24 kV

Operation counter

CTs for IMC (quantity)

1

2

3

Busbar field distributors for severe conditions (only for 630 A)

Internal arc version (not possible with "top incomer" option)

16 kA 1s

20 kA 1s

Internal arc classification

A-FLR

Gaz exhaust direction

Upwards

Thermal monitoring

Arc detection

Seismic performance

Ambient monitoring

QM cubicle only

SM6-36 options

Cable connection by the top (single core cable maxi 240 mm² with VPIS)

Cable connection by the bottom (2 x single core, cable maxi 240 mm², not applicable on IMC)

Surge arresters (not applicable on IMB, IMC cubicles)





36 kV

SM6 switching

Automatic Transfer System

Basic cubicle

Only one of the boxes
 - ticked
 - or filled
 by the needed value
 have to be considered
 between each
 horizontal line.



Basic cubicle		Quantity
Rated voltage Ur		(kV) <input type="text"/>
Service voltage		(kV) <input type="text"/>
Short-circuit current I_{sc}		(kA) <input type="text"/>
Rated current I_r		(A) <input type="text"/>
Internal arc withstand	12.5 kA 1s for SM6-24 <input type="checkbox"/>	16 kA 1s for SM6-36 <input type="checkbox"/>
Internal arc classification		A-FL
Gaz exhaust direction		Downwards
Type of cubicle/upper busbar for 24 kV		
I _r = 630 A, I _r busbar = 400 A	NSM busbar <input type="checkbox"/>	NSM cable <input type="checkbox"/>
I _r = 630 A, I _r busbar = 630 A	NSM busbar <input type="checkbox"/>	NSM cable <input type="checkbox"/>
I _r = 630 A, I _r busbar = 1250 A		NSM cable <input type="checkbox"/>
Position in the switchboard	First on left <input type="checkbox"/>	Middle <input type="checkbox"/> Last on right <input type="checkbox"/>
Direction of lower busbars for GBC-A		see page 169
Direction of lower busbar for IMM	Left  <input type="checkbox"/>	Right  <input type="checkbox"/>
Incoming bottom busbar for NSM busbar	Left  <input type="checkbox"/>	Right  <input type="checkbox"/>
Cable connection by the bottom (cable maximum 240 mm²) for NSM cable		
Three core on both <input type="checkbox"/>	Single core on both <input type="checkbox"/>	2 x single core on both <input type="checkbox"/>
Stand by source		Generator without paralleling <input type="checkbox"/>
	Utility with paralleling <input type="checkbox"/>	Utility without paralleling <input type="checkbox"/>
Control unit HMI language		
French <input type="checkbox"/>	English <input type="checkbox"/>	Spanish <input type="checkbox"/> Portuguese <input type="checkbox"/> Chinese <input type="checkbox"/>

SM6 switching

Automatic Transfer System

Options

Only one of the boxes
 - ticked
 - or filled
 by the needed value
 have to be considered
 between each
 horizontal line.

Common options				
Signalling contact		1 C on SW and 1 O & 1 C on ES	<input type="checkbox"/>	
Operation counter			<input type="checkbox"/>	
		Tubular key type 	<input type="checkbox"/>	
		Flat key type 	<input type="checkbox"/>	
Interlocking SM6-SM6	1 x P1	Right cubicle	<input type="checkbox"/>	
		Left cubicle	<input type="checkbox"/>	
	2 x P1	Right and left cubicle <input type="checkbox"/>		
	1 x A3	Right cubicle	<input type="checkbox"/>	
		Left cubicle	<input type="checkbox"/>	
	2 x A3	On switch	<input type="checkbox"/>	
	P3 SM6-SM6	<input type="checkbox"/>		
	2 x A3 Right cubicle	On switch	<input type="checkbox"/>	
	Left cubicle	On earthing switch	<input type="checkbox"/>	
		On earthing switch	<input type="checkbox"/>	
Control and monitoring	Protocol type	DNP3 <input type="checkbox"/>	IEC 101/204 <input type="checkbox"/>	
		Modbus (by default)	<input type="checkbox"/>	
	Modem type	FFSK <input type="checkbox"/>	RS485 <input type="checkbox"/>	RS232 (by default)
			PSTN <input type="checkbox"/>	GSM <input type="checkbox"/>
		FSK	<input type="checkbox"/>	

SM6-24 options	
2 heating elements	<input type="checkbox"/>
Busbar field distributors for severe conditions (only for 630 A)	<input type="checkbox"/>
Internal arc version (not possible with "top incomer" option)	16 kA 1s <input type="checkbox"/>
	20 kA 1s <input type="checkbox"/>
Internal arc classification	A-FLR <input type="checkbox"/>
Gaz exhaust direction	Upwards <input type="checkbox"/>
Arc detection	<input type="checkbox"/>
Thermal monitoring	<input type="checkbox"/>

SM6 protection

Circuit breaker

Basic cubicle

Only one of the boxes
 - ticked
 - or filled
 by the needed value
 have to be considered
 between each
 horizontal line.

Basic common cubicle 24/36 kV		Quantity		
Rated voltage Ur		(kV) <input type="text"/>		
Service voltage		(kV) <input type="text"/>		
Short-circuit current Isc		(kA) <input type="text"/>		
Rated current Ir		(A) <input type="text"/>		
Internal arc withstand	12.5 kA 1s for SM6-24 <input type="checkbox"/>	16 kA 1s for SM6-36 <input type="checkbox"/>		
Internal arc classification		A-FL		
Gaz exhaust direction		Downwards		
Type of cubicle				
24 kV	For SF1 circuit breaker	DM1-A 750 <input type="checkbox"/>	DM1-D left 750 <input type="checkbox"/>	DM1-D right 750 <input type="checkbox"/>
		DM1-S 750 <input type="checkbox"/>	DM1-Z 750 <input type="checkbox"/>	DM1-W 750 <input type="checkbox"/>
		DM1-M right <input type="checkbox"/>	DM2 left 750 <input type="checkbox"/>	DM2 right 750 <input type="checkbox"/>
	For SFset circuit breaker		DM1-D left 750 <input type="checkbox"/>	DM1-D right 750 <input type="checkbox"/>
	For Evolis frontal 630 A CB	DMV-A <input type="checkbox"/>		DMV-D right <input type="checkbox"/>
	For Evolis lateral 630 A CB		DMVL-A <input type="checkbox"/>	DMVL-D <input type="checkbox"/>
36 kV	For SF1 circuit breaker	DM1-A 1000 <input type="checkbox"/>	DM1-D left 1000 <input type="checkbox"/>	DM1-D right 1000 <input type="checkbox"/>
			DM2 left 1500 <input type="checkbox"/>	DM2 right 1500 <input type="checkbox"/>
Position in the switchboard	First on left <input type="checkbox"/>	Middle <input type="checkbox"/>	Last on right <input type="checkbox"/>	
Circuit breaker		See specific order form		
Current transformers (CT) and LPCTs		See specific order form		
Protection relay (see specific order form)	Easergy Sepam relay <input type="checkbox"/>	Easergy P3 relay <input type="checkbox"/>		
Cable connection by the bottom (1x single core, cable maxi 240 mm ²)		36 kV	<input type="checkbox"/>	
Cable connection by the bottom (1x single core, cable maximum 240 mm ²)		36 kV	<input type="checkbox"/>	

SM6 protection

Circuit breaker

Basic cubicle

Only one of the boxes
 - ticked
 - or filled
 by the needed value
 have to be considered
 between each
 horizontal line.

Basic cubicle SM6-24		Quantity <input type="text"/>
Busbar (I _r ≥ I _r cubicle)		
For DM1-M	630 A <input type="checkbox"/>	
For DM1-A, DM1-S, DM1-W, DMVL-A, DMVL-D, DM1-D, DM2	400 A <input type="checkbox"/> 630 <input type="checkbox"/>	1250 A <input type="checkbox"/>
For DM1-A, DM1-D, DM1-W, DM1-Z		1250 A <input type="checkbox"/>
For DMV-A, DMV-D	630 <input type="checkbox"/>	1250 A <input type="checkbox"/>
Protection		
For DM1-S	VIP45 <input type="checkbox"/> VIP410 only D1S <input type="checkbox"/>	VIP400 <input type="checkbox"/>
	VIP400 with CGas <input type="checkbox"/>	VIP400 with CGbs <input type="checkbox"/>
For DMV-A, DMV-D	Easergy P3 relay <input type="checkbox"/>	Easergy Sepam series 20/40 <input type="checkbox"/>
Control for DMV-A and DMV-D		
Local (shunt trip coil compulsory)		<input type="checkbox"/>
Remote (opening coil and closing coil compulsory)		<input type="checkbox"/>
Local and remote (opening coil and closing compulsory)		<input type="checkbox"/>
Voltage of the auxiliaries	48/60 Vdc <input type="checkbox"/>	110/125 or 220/250 Vdc <input type="checkbox"/>
		110/130 or 220/240 Vac (50 Hz) <input type="checkbox"/>
Voltage of signalling	48/60 Vdc <input type="checkbox"/> 110/125 Vdc <input type="checkbox"/>	220/250 Vdc <input type="checkbox"/>
	110/130 Vac (50 Hz) <input type="checkbox"/>	220/240 Vac (50 Hz) <input type="checkbox"/>
Cable connection by the bottom (For DM1-A, DM1-W, DMVL-A)		
	3 x single core cable maxi 240 mm ² <input type="checkbox"/>	6 x single core cable maxi 240 mm ² <input type="checkbox"/>
Current sensors	CT <input type="checkbox"/>	LPCT ring type for DM1-A 630 A <input type="checkbox"/>
		LPCT MV type for DM1-D <input type="checkbox"/>

Basic cubicle SM6-36		Quantity <input type="text"/>
Current sensors	CT <input type="checkbox"/>	LPCT ring type for DM1-A 630 A <input type="checkbox"/>

SM6 protection

Circuit breaker

Options

Only one of the boxes
 - ticked
 - or filled
 by the needed value
 have to be considered
 between each
 horizontal line.

Common options	
Operation counter	<input type="checkbox"/>
Interlocking	Tubular key type <input checked="" type="checkbox"/> <input type="checkbox"/> Flat key type <input checked="" type="checkbox"/> <input type="checkbox"/> Not applicable on DM2 A1 <input type="checkbox"/> C1 <input type="checkbox"/> C4 <input type="checkbox"/>
Signalling contact	2 O & 2 C on SW (not applicable with VTs) <input type="checkbox"/> 1 O & 2 C on SW (available only on cubicle with VTs) <input type="checkbox"/>
VTs (not applicable for DM1-S)	See specific order form

SM6-24 options	
Roof configuration - A, B or C only one choice possible (not applicable on DMV-A, DMV-D)	
A - Cable connection by the top (cable maxi 240 mm ² with VPIS)	
	Single core <input type="checkbox"/> 2 x single core <input type="checkbox"/>
DM2	1 set <input type="checkbox"/> 2 sets <input type="checkbox"/>
B - Low voltage control cabinet	DM2 1 cabinet <input type="checkbox"/> 2 cabinets <input type="checkbox"/>
C - Wiring duct	DM2 1 set <input type="checkbox"/> 2 sets <input type="checkbox"/>
	Other cubicles 1 set <input type="checkbox"/>
Surge arrester	<input type="checkbox"/>
50 W heating element	<input type="checkbox"/>
Replacement of 630 A upper busbars 400-630 A by 1250 A	<input type="checkbox"/>
Busbar field distributors for severe conditions (only for 630 A)	<input type="checkbox"/>
Internal arc version (not possible with "top incomer" option)	16 kA 1 s <input type="checkbox"/> 20 kA 1 s <input type="checkbox"/>
Internal arc classification	A-FLR <input type="checkbox"/>
Gaz exhaust direction	Upwards <input type="checkbox"/>
DM1-A without LPCT, DM1-S, DM1-W, DM1-M	Thermal monitoring <input type="checkbox"/>
Arc detection	<input type="checkbox"/>
Seismic performance	<input type="checkbox"/>
Ambient monitoring	only DM1A <input type="checkbox"/>



SM6-36 options	
Cable connection by the top (single core cable maxi 240 mm ² with VPIS)	<input type="checkbox"/>
Cable connection by the bottom (for DM1-A only)	3 x 2 x single core cable maxi 240 mm ² <input checked="" type="checkbox"/>
Surge arrester	36 kV <input type="checkbox"/>
Easergy Sepam relay protection	See specific order form <input type="checkbox"/>
Easergy P3 relay	See specific order form <input type="checkbox"/>

SM6 protection

Fuse switch

Basic cubicle

Only one of the boxes
 - ticked
 - or filled
 by the needed value
 have to be considered
 between each
 horizontal line.



Basic cubicle		Quantity	
Rated voltage Ur		(kV) <input type="text"/>	
Service voltage		(kV) <input type="text"/>	
Short-circuit current I_{sc}		(kA) <input type="text"/>	
Rated current I_r		(A) <input type="text"/>	
Internal arc withstand	12.5 kA 1s for SM6-24 <input type="checkbox"/>	16 kA 1s for SM6-36 <input type="checkbox"/>	
Internal arc classification		A-FL	
Gaz exhaust direction		Downwards	
Type of cubicle			
SM6-24	QM 375 <input type="checkbox"/>	QMB 375 <input type="checkbox"/> QMC 625 <input type="checkbox"/>	PM 375 <input type="checkbox"/>
	QM 500 <input type="checkbox"/>		
SM6-36	QM 750 <input type="checkbox"/>	QMB 750 <input type="checkbox"/> QMC 1000 <input type="checkbox"/>	PM 750 <input type="checkbox"/>
Position in the switchboard	First on left <input type="checkbox"/>	Middle <input type="checkbox"/>	Last on right <input type="checkbox"/>
Current transformers for QMC 24 kV (to see price structure)	1 CT <input type="checkbox"/>	2 CTs <input type="checkbox"/>	3 CTs <input type="checkbox"/>
Direction of lower busbars for QMB	Left (impossible as first cubicle of switchboard)  <input type="checkbox"/>	Right  <input type="checkbox"/>	
Cable connection by the bottom (1x single core, cable maximum 240 mm ²)		36 kV <input type="checkbox"/>	

SM6 protection

Fuse switch

Options

Only one of the boxes
 - ticked
 - or filled
 by the needed value
 have to be considered
 between each
 horizontal line.

Common options			
Fuses (see fuse price structure)		Service voltage ≤ 12 kV <input type="checkbox"/>	
Replacement of mechanism		CIT by CI1 (only for PM) <input type="checkbox"/>	
Motorization	Standard <input type="checkbox"/>	Severe and communication <input type="checkbox"/>	
Electrical driving motorization	24 Vdc <input type="checkbox"/>	110 Vdc <input type="checkbox"/>	120/127 Vac (50 Hz) <input type="checkbox"/>
	32 Vdc <input type="checkbox"/>	120-125 Vdc <input type="checkbox"/>	220/230 Vac (50 Hz) <input type="checkbox"/>
	48 Vdc <input type="checkbox"/>	137 Vdc <input type="checkbox"/>	120/127 Vac (60 Hz) <input type="checkbox"/>
	60 Vdc <input type="checkbox"/>	220 Vdc <input type="checkbox"/>	220/230 Vac (60 Hz) <input type="checkbox"/>
Shunt trip	Opening (on CI1) <input type="checkbox"/>	Closing and opening (on CI2) <input type="checkbox"/>	
	24 Vdc <input type="checkbox"/>	<input type="checkbox"/>	120/127 Vac (50 Hz) <input type="checkbox"/>
	32 Vdc <input type="checkbox"/>	<input type="checkbox"/>	220/230 Vac (50 Hz) <input type="checkbox"/>
	48 Vdc <input type="checkbox"/>	<input type="checkbox"/>	120/127 Vac (60 Hz) <input type="checkbox"/>
	60 Vdc <input type="checkbox"/>	<input type="checkbox"/>	220/230 Vac (60 Hz) <input type="checkbox"/>
Auxiliary contact signalling		1 C on SW and 1 O & 1 C on ES <input type="checkbox"/>	
2 O & 2 C on SW <input type="checkbox"/>		2 O & 3 C on SW and 1 O & 1 C on ES <input type="checkbox"/>	
Interlocking			
A1 <input type="checkbox"/>	C1 <input type="checkbox"/>	C4 <input type="checkbox"/>	Tubular key type  <input type="checkbox"/> Flat key type  <input type="checkbox"/>
Replacement of 630 A upper busbar by 1250 A (not possible for QMB)			<input type="checkbox"/>
Blown fuse signalling contact (for QM, QMB, QMC)			<input type="checkbox"/>
Visibility of main contacts			<input type="checkbox"/>
Pressure indicator device		Analogic manometer without visibility of main contacts <input type="checkbox"/>	
Pressure switch <input type="checkbox"/>		Analogic manometer with visibility of main contacts <input type="checkbox"/>	

SM6 protection

Fuse switch

Options

Only one of the boxes

- ticked

- or filled

by the needed value
have to be considered
between each
horizontal line.

SM6-24 options

Replacement of mechanism	CI1 by CI2 (only for QM) <input type="checkbox"/>		
Remote control signalling (for QM only)			
	2 lights <input type="checkbox"/>	2 lights and 2 PB <input type="checkbox"/>	2 lights and 2 PB + 1 switch <input type="checkbox"/>
Voltage of the lights (must be the same than electrical driving mechanism)	<input type="checkbox"/>		
	24 V <input type="checkbox"/>	48 V <input type="checkbox"/>	110/125 V <input type="checkbox"/>
			220 V <input type="checkbox"/>
Blown fuse signalling contact (mechanical indication PM, electrical for the other cubicles)	<input type="checkbox"/>		
Roof configuration - A, B or C only one choice possible (not applicable on DMV-A, DMV-D)			
A - Cable connection by the top (cable maximum 240 mm ² with VPIS)	Single core <input type="checkbox"/>	2 x single core <input type="checkbox"/>	
B - Low voltage control cabinet (h = 450 mm)	<input type="checkbox"/>	With unpunched door <input type="checkbox"/>	
C - Wiring duct	<input type="checkbox"/>		
50 W heating element	<input type="checkbox"/>		
Operation counter	<input type="checkbox"/>		
Digital ammeter (not applicable for QMB)	AMP21D <input type="checkbox"/>		
Busbar field distributors for severe conditions (only for 630 A)	<input type="checkbox"/>		
Internal arc version (not possible with "top incomer" option)	16 kA 1s <input type="checkbox"/>	20 kA 1s <input type="checkbox"/>	
Internal arc classification	A-FLR <input type="checkbox"/>		
Gaz exhaust direction	Upwards <input type="checkbox"/>		
QM, QMC, PM	Thermal monitoring <input type="checkbox"/>		
Arc detection	<input type="checkbox"/>		
Seismic performance	<input type="checkbox"/>		
Ambient monitoring	QM cubicle only <input type="checkbox"/>		



SM6-36 options



Replacement of mechanism	CIT by CI2 (only for PM) <input type="checkbox"/>
Cable connection by the top (single core cable maxi 240 mm ² with VPIS)	<input type="checkbox"/>

SM6 protection

Vacuum contactor (Direct Motor Starter) for SM6-24

Only one of the boxes
 - ticked
 - or filled
 by the needed value
 have to be considered
 between each
 horizontal line.

Basic cubicle		Quantity
Rated voltage Ur		(kV) <input type="text"/>
Service voltage		(kV) <input type="text"/>
Short-circuit current I _{sc} (6.3 kA without fuse)		(kA) <input type="text"/>
Rated current I _r (max. 400 A without fuse)		(A) <input type="text"/>
Internal arc withstand	12.5 kA 1s for SM6-24 <input type="checkbox"/>	16 kA 1s for SM6-36 <input type="checkbox"/>
Internal arc classification		A-FL
Gaz exhaust direction		Downwards
Thermal monitoring		<input type="checkbox"/>
Arc detection		<input type="checkbox"/>
Position in the switchboard	First on left <input type="checkbox"/>	Middle <input type="checkbox"/> Last on right <input type="checkbox"/>
Busbar I _r	400 A <input type="checkbox"/>	630 A <input type="checkbox"/> 1250 A <input type="checkbox"/>
Phase current sensors	1 CT <input type="checkbox"/>	2 CT <input type="checkbox"/> 3 CT <input type="checkbox"/>
		3 LPCT ring type <input type="checkbox"/>
Key interlockings for 52 type	Tubular key type  <input type="checkbox"/>	Flat key type  <input type="checkbox"/>

Options	
MV fuses	25 A <input type="checkbox"/> 31.5 A <input type="checkbox"/> 40 A <input type="checkbox"/> 50 A <input type="checkbox"/> 63 A <input type="checkbox"/> 80 A <input type="checkbox"/> 100 A <input type="checkbox"/> 125 A <input type="checkbox"/> 160 A <input type="checkbox"/> 200 A <input type="checkbox"/> 250 A <input type="checkbox"/>
Busbar field distributors for severe conditions (only for 630 A)	<input type="checkbox"/>
Voltage transformer (quantity)	1 <input type="checkbox"/> 2 <input type="checkbox"/> 3 <input type="checkbox"/>
Key interlockings for C1 type	Tubular key type  <input type="checkbox"/> Flat key type  <input type="checkbox"/>
Internal arc version (not possible with "top incomer" option)	16 kA 1 s <input type="checkbox"/> 20 kA 1 s <input type="checkbox"/>
Internal arc classification	A-FLR <input type="checkbox"/>
Gaz exhaust direction	Upwards <input type="checkbox"/>

Contactor	
Vacuum contactor	Magnetic hold <input type="checkbox"/> Mechanical latching <input type="checkbox"/>
Open release	48 Vdc <input type="checkbox"/> 125 Vdc <input type="checkbox"/> 250 Vdc <input type="checkbox"/>
Closing coil	110 Vac/dc <input type="checkbox"/> 120 Vac/dc <input type="checkbox"/> 125 Vac/dc <input type="checkbox"/>
	220 Vac/dc <input type="checkbox"/> 240 Vac/dc <input type="checkbox"/> 250 Vac/dc <input type="checkbox"/>

SM6 metering

Basic cubicle

Only one of the boxes
 - ticked
 - or filled
 by the needed value
 have to be considered
 between each
 horizontal line.

Basic common cubicle 24/36 kV		Quantity	<input type="text"/>
Rated voltage Ur		(kV)	<input type="text"/>
Service voltage		(kV)	<input type="text"/>
Short-circuit current I_{sc}		(kA)	<input type="text"/>
Rated current I_r		(A)	<input type="text"/>
Internal arc withstand	12.5 kA 1s for SM6-24 <input type="checkbox"/>	16 kA 1s for SM6-36 <input type="checkbox"/>	
Internal arc classification			A-FL
Gaz exhaust direction			Downwards
Type of cubicle/upper busbar for SM6-24			
I _r = 630 A, I _r busbar = 400 A	CM <input type="checkbox"/>	CM2 <input type="checkbox"/>	TM <input type="checkbox"/>
	GBC-A <input type="checkbox"/>	GBC-B <input type="checkbox"/>	
I _r = 630 A, I _r busbar = 630 A	CM <input type="checkbox"/>	CM2 <input type="checkbox"/>	TM <input type="checkbox"/>
	GBC-A <input type="checkbox"/>	GBC-B <input type="checkbox"/>	
I _r = 630 A, I _r busbar = 1250 A	CM <input type="checkbox"/>	CM2 <input type="checkbox"/>	TM <input type="checkbox"/>
	GBC-A <input type="checkbox"/>	GBC-B <input type="checkbox"/>	
I _r = 1250 A, I _r busbar = 1250 A			<input type="checkbox"/>
	GBC-A <input type="checkbox"/>	GBC-B <input type="checkbox"/>	
Type of cubicle for SM6-36	CM 750 <input type="checkbox"/>	CM 750 <input type="checkbox"/>	GBC-A 750 <input type="checkbox"/>
		TM 750 <input type="checkbox"/>	GBC-B 750 <input type="checkbox"/>
Position in the switchboard	First on left <input type="checkbox"/>	Middle <input type="checkbox"/>	Last on right <input type="checkbox"/>
Direction of lower busbars for GBC-A		Left <input type="checkbox"/>	Right <input type="checkbox"/>
Signalling contact (for CM, CM2 and TM only)			1 O and 1 C on SW <input type="checkbox"/>
Fuses (for CM, CM2 and TM only)			<input type="checkbox"/>
Cable connection by the bottom (1x single core, cable maxi 240 mm ²)			SM6-36 <input type="checkbox"/>

Basic SM6-24			
VTs for GBC (to see price structure)		Phase/phase <input type="checkbox"/>	Phase/earth <input type="checkbox"/>
CTs for GBC (to see price structure)		Quantity	1 <input type="checkbox"/> 2 <input type="checkbox"/> 3 <input type="checkbox"/>
Ratio choice for GBC	Protections	1 secondary <input type="checkbox"/>	1 high secondary <input type="checkbox"/>
		2 secondaries <input type="checkbox"/>	1 low secondary <input type="checkbox"/>

Basic SM6-36	
Voltage transformers	See specific order form

SM6 metering

Options

Only one of the boxes
 - ticked
 - or filled
 by the needed value
 have to be considered
 between each
 horizontal line.

SM6-24 options

Roof configuration - A, B or C only one choice possible (not applicable on DMV-A, DMV-D)

A - Cable connection by the top (cable maxi 240 mm² with VPIS) Single core 2 x single core

B - Low voltage control cabinet (h = 450 mm) With unpunched door

C - Wiring duct

50 W heating element for CM, CM2, TM

Busbar field distributors for severe conditions (only for 630 A and CM, CM2 and TM cubicles)

Blown fuse auxiliary contact (for CM, CM2 and TM only) 1 O and 1 C

Internal arc version (not possible with "top incomer" option) 16 kA 1s 20 kA 1s

Internal arc classification A-FLR

Gaz exhaust direction Upwards

Thermal monitoring

Arc detection

SM6-36 options

Current transformers and voltage transformers for GBC See specific order form

Cable connection by the top (single core cable maxi 240 mm² with VPIS)



Replacement of 630 A busbar by 1250 A (for CM, CM2 and TM only)

SM6 other functions

Basic and options

Only one of the boxes
 - ticked
 - or filled
 by the needed value
 have to be considered
 between each
 horizontal line.

Basic cubicle		Quantity	<input type="text"/>
Rated voltage Ur		(kV)	<input type="text"/>
Service voltage		(kV)	<input type="text"/>
Short-circuit current Isc		(kA)	<input type="text"/>
Rated current Ir		(A)	<input type="text"/>
Internal arc withstand	12.5 kA 1s for SM6-24 <input type="checkbox"/>	16 kA 1s for SM6-36 <input type="checkbox"/>	
Internal arc classification	A-FL		
Gaz exhaust direction	Downwards		
Type of cubicle/upper busbar for SM6-24			
Ir = 630 A, Ir busbar = 400 A	GAM 500 <input type="checkbox"/>	GAM2 375 <input type="checkbox"/>	GBM 375 <input type="checkbox"/>
Ir = 630 A, Ir busbar = 630 A	GAM 500 <input type="checkbox"/>	GAM2 375 <input type="checkbox"/>	GBM 375 <input type="checkbox"/>
Ir = 1250 A, Ir busbar = 1250 A	GAM 500 <input type="checkbox"/>		GBM 375 <input type="checkbox"/>
Type of cubicle for SM6-36	GAM 750 <input type="checkbox"/>	GAM2 750 <input type="checkbox"/>	GBM 750 <input type="checkbox"/>
Position in the switchboard	First on left <input type="checkbox"/>	Middle <input type="checkbox"/>	Last on right <input type="checkbox"/>
Direction of lower busbars for GBC-A	Left (impossible on the first cubicle of the switchboard) <input type="checkbox"/>		Right <input type="checkbox"/>
Cable connection by the bottom (1x single core, cable maxi 240 mm ²)	SM6-36 <input type="checkbox"/>		

SM6-24 options			
Roof configuration - A, B or C only one choice possible (not applicable on DMV-A, DMV-D)			
A - Cable connection by the top (cable maximum 240 mm ² with VPIS)	Single core <input type="checkbox"/>	2 x single core <input type="checkbox"/>	
B - Low voltage control cabinet (h = 450 mm)	<input type="checkbox"/>	With unpunched door <input type="checkbox"/>	
C - Wiring duct	<input type="checkbox"/>		
Wiring duct for GBM	<input type="checkbox"/>		
ES auxiliary contact (only on GAM 500)	1 O and 1 C <input type="checkbox"/>		
Surge arresters for GAM 500, 630 A	7.2 kV <input type="checkbox"/>	10 kV <input type="checkbox"/>	12 kV <input type="checkbox"/>
	17.5 kV <input type="checkbox"/>	SM6-24 <input type="checkbox"/>	
Interlocking on GAM 500	Tubular key type  <input type="checkbox"/>	Flat key type  <input type="checkbox"/>	
	A3 SM6-SM6 <input type="checkbox"/>		
Heating element (on GAM 500 630 A and on GAM2)	<input type="checkbox"/>		
Digital ammeter or Fault current indicator	AMP 21D (except GBM) <input type="checkbox"/>	Flair 23DV zero sequence <input type="checkbox"/>	
	Flair 21D <input type="checkbox"/>	Flair 22D <input type="checkbox"/>	Flair 23DV <input type="checkbox"/>
Internal arc version (not possible with "top incomer" option)	16 kA 1s <input type="checkbox"/>	20 kA 1s <input type="checkbox"/>	
Internal arc classification	A-FLR <input type="checkbox"/>		
Gaz exhaust direction	Upwards <input type="checkbox"/>		
Thermal monitoring	<input type="checkbox"/>		
Arc detection	<input type="checkbox"/>		

SM6-36 options	
Cable connection by the top (single core cable maxi 240 mm ² with VPIS)	<input type="checkbox"/>
Replacement of 630 A busbar by 1250 A (for GAM2 only)	<input type="checkbox"/>
Surge arresters for GAM2	<input type="checkbox"/>

SF1 lateral / frontal fixed

Basic and options

Only one of the boxes
 - ticked
 - or filled
 by the needed value
 have to be considered
 between each
 horizontal line.

Basic fixed SF1 circuit breaker		Quantity	<input type="text"/>	
Rated voltage U_r	(kV)	<input type="text"/>		
Impulse voltage U_p	(kVbil)	<input type="text"/>		
Short-circuit current I_{sc}	(kA)	<input type="text"/>		
Rated current I_r	(A)	<input type="text"/>		
Frequency	50 Hz <input type="checkbox"/>	60 Hz <input type="checkbox"/>		
Operating mechanism position	A1 <input type="checkbox"/>	B1 <input type="checkbox"/>	C1 <input type="checkbox"/>	
Color for push buttons and indicators				
	IEC Red/Black <input type="checkbox"/>	IEC Red/Green <input type="checkbox"/>	ANSI Red/Green <input type="checkbox"/> ANSI Red/Black <input type="checkbox"/>	
Indicator open/close		IEC Black/White <input type="checkbox"/>	ANSI Red/Green <input type="checkbox"/>	
Operating mechanism charged/discharged		IEC White/Yellow <input type="checkbox"/>	ANSI Charged/Discharged <input type="checkbox"/>	
Fixed SF1 circuit breaker options				
1st opening release (see possible combinations in the table below)				
Shunt opening release YO1	24 Vdc <input type="checkbox"/>	60 Vdc <input type="checkbox"/>	220 Vdc <input type="checkbox"/> 220 Vac (50 Hz) <input type="checkbox"/>	
	30 Vdc <input type="checkbox"/>	110 Vdc <input type="checkbox"/>	48 Vac (50 Hz) <input type="checkbox"/> 120 Vac (60 Hz) <input type="checkbox"/>	
	48 Vdc <input type="checkbox"/>	125 Vdc <input type="checkbox"/>	110 Vac (50 Hz) <input type="checkbox"/> 240 Vac (60 Hz) <input type="checkbox"/>	
Undervoltage release YM	24 Vdc <input type="checkbox"/>	60 Vdc <input type="checkbox"/>	220 Vdc <input type="checkbox"/> 220 Vac (50 Hz) <input type="checkbox"/>	
	30 Vdc <input type="checkbox"/>	110 Vdc <input type="checkbox"/>	48 Vac (50 Hz) <input type="checkbox"/> 120 Vac (60 Hz) <input type="checkbox"/>	
	48 Vdc <input type="checkbox"/>	125 Vdc <input type="checkbox"/>	110 Vac (50 Hz) <input type="checkbox"/> 240 Vac (60 Hz) <input type="checkbox"/>	
Mitop		Without contact <input type="checkbox"/>	With contact <input type="checkbox"/>	
2nd opening release (see possible combinations in the table below)				
Shunt opening release YO2	24 Vdc <input type="checkbox"/>	60 Vdc <input type="checkbox"/>	220 Vdc <input type="checkbox"/> 220 Vac (50 Hz) <input type="checkbox"/>	
	30 Vdc <input type="checkbox"/>	110 Vdc <input type="checkbox"/>	48 Vac (50 Hz) <input type="checkbox"/> 120 Vac (60 Hz) <input type="checkbox"/>	
	48 Vdc <input type="checkbox"/>	125 Vdc <input type="checkbox"/>	110 Vac (50 Hz) <input type="checkbox"/> 240 Vac (60 Hz) <input type="checkbox"/>	
Undervoltage release YM	24 Vdc <input type="checkbox"/>	60 Vdc <input type="checkbox"/>	220 Vdc <input type="checkbox"/> 220 Vac (50 Hz) <input type="checkbox"/>	
	30 Vdc <input type="checkbox"/>	110 Vdc <input type="checkbox"/>	48 Vac (50 Hz) <input type="checkbox"/> 120 Vac (60 Hz) <input type="checkbox"/>	
	48 Vdc <input type="checkbox"/>	125 Vdc <input type="checkbox"/>	110 Vac (50 Hz) <input type="checkbox"/> 240 Vac (60 Hz) <input type="checkbox"/>	
Mitop		Without contact <input type="checkbox"/>	With contact <input type="checkbox"/>	
Remote control	Electrical motor M		24...32 Vdc <input type="checkbox"/> 110...127 Vdc/ac <input type="checkbox"/>	
			48...60 Vdc/ac <input type="checkbox"/> 220...250 Vdc/ac <input type="checkbox"/>	
	Shunt closing release YF	24 Vdc <input type="checkbox"/>	60 Vdc <input type="checkbox"/>	220 Vdc <input type="checkbox"/> 220 Vac (50 Hz) <input type="checkbox"/>
		30 Vdc <input type="checkbox"/>	110 Vdc <input type="checkbox"/>	48 Vac (50 Hz) <input type="checkbox"/> 120 Vac (60 Hz) <input type="checkbox"/>
		48 Vdc <input type="checkbox"/>	125 Vdc <input type="checkbox"/>	110 Vac (50 Hz) <input type="checkbox"/> 240 Vac (60 Hz) <input type="checkbox"/>
	Low voltage wiring connection		Male plug (1.2 m) <input type="checkbox"/>	Female socket (2 m) <input type="checkbox"/>
Locking C.B. in open position		Flat <input type="checkbox"/>	Tubular <input type="checkbox"/>	
Support frame		Low (560 mm) <input type="checkbox"/>	High (775 mm) <input type="checkbox"/>	
Leaflets language		French <input type="checkbox"/>	English <input type="checkbox"/>	
Pressure switch		<input type="checkbox"/>	<input type="checkbox"/>	

SF1 - Possible opening releases combinations	Release	Combinations						
	Low energy Mitop		1				1	1
	Shunt trip YO1/YO2	1			2	1	1	
Undervoltage YM			1		1		1	

SFset

Lateral / frontal fixed

Basic and options

Only one of the boxes
 - ticked
 - or filled
 by the needed value
 have to be considered
 between each
 horizontal line.

Basic frontal fixed SFset circuit breaker		Quantity
Rated voltage U_r	(kV)	<input type="text"/>
Impulse voltage U_p	(kVbil)	<input type="text"/>
Short-circuit current I_{sc}	(kA)	<input type="text"/>
Rated current I_r	(A)	<input type="text"/>
Frequency	50 Hz <input type="checkbox"/>	60 Hz <input type="checkbox"/>
Operating mechanism position	A1 <input type="checkbox"/>	B1 <input type="checkbox"/> C1 <input type="checkbox"/>
Color for push buttons and indicators		
IEC Red/Black <input type="checkbox"/>	IEC Red/Green <input type="checkbox"/>	ANSI Red/Green <input type="checkbox"/> ANSI Red/Black <input type="checkbox"/>
Indicator open/close	IEC Black/White <input type="checkbox"/>	ANSI Red/Green <input type="checkbox"/>
Operating mechanism charged/discharged	IEC White/Yellow <input type="checkbox"/>	ANSI Charged/Discharged <input type="checkbox"/>

Control unit and sensors	
VIP 400 (not available for all electrical characteristics)	CSa4 200A <input type="checkbox"/> CSb4 630A <input type="checkbox"/>
VIP410A	CSa4 200A <input type="checkbox"/>
VIP410E	CSb4 630A <input type="checkbox"/>

Frontal fixed SFset circuit breaker options		
2nd opening release (see possible combinations in the table below)		
Shunt opening release YO2	24 Vdc <input type="checkbox"/> 60 Vdc <input type="checkbox"/> 220 Vdc <input type="checkbox"/> 220 Vac (50 Hz) <input type="checkbox"/>	
	30 Vdc <input type="checkbox"/> 110 Vdc <input type="checkbox"/> 48 Vac (50 Hz) <input type="checkbox"/> 120 Vac (60 Hz) <input type="checkbox"/>	
	48 Vdc <input type="checkbox"/> 125 Vdc <input type="checkbox"/> 110 Vac (50 Hz) <input type="checkbox"/> 240 Vac (60 Hz) <input type="checkbox"/>	
Undervoltage release YM	24 Vdc <input type="checkbox"/> 60 Vdc <input type="checkbox"/> 220 Vdc <input type="checkbox"/> 220 Vac (50 Hz) <input type="checkbox"/>	
	30 Vdc <input type="checkbox"/> 110 Vdc <input type="checkbox"/> 48 Vac (50 Hz) <input type="checkbox"/> 120 Vac (60 Hz) <input type="checkbox"/>	
	48 Vdc <input type="checkbox"/> 125 Vdc <input type="checkbox"/> 110 Vac (50 Hz) <input type="checkbox"/> 240 Vac (60 Hz) <input type="checkbox"/>	
Remote control	Electrical motor M	
	24...32 Vdc <input type="checkbox"/> 110...127 Vdc/ac <input type="checkbox"/>	
	48...60 Vdc/ac <input type="checkbox"/> 220...250 Vdc/ac <input type="checkbox"/>	
	Shunt closing release YF	24 Vdc <input type="checkbox"/> 60 Vdc <input type="checkbox"/> 220 Vdc <input type="checkbox"/> 220 Vac (50 Hz) <input type="checkbox"/>
		30 Vdc <input type="checkbox"/> 110 Vdc <input type="checkbox"/> 48 Vac (50 Hz) <input type="checkbox"/> 120 Vac (60 Hz) <input type="checkbox"/>
		48 Vdc <input type="checkbox"/> 125 Vdc <input type="checkbox"/> 110 Vac (50 Hz) <input type="checkbox"/> 240 Vac (60 Hz) <input type="checkbox"/>
Low voltage wiring connection	Male plug (1.2 m) <input type="checkbox"/> Female socket (2 m) <input type="checkbox"/>	
Locking C.B. in open position	Flat <input type="checkbox"/> Tubular <input type="checkbox"/>	
Support frame	Low (560 mm) <input type="checkbox"/> High (775 mm) <input type="checkbox"/>	
Pocket battery	<input type="checkbox"/>	
Leaflets language	French <input type="checkbox"/> English <input type="checkbox"/>	
Pressure switch	<input type="checkbox"/> <input type="checkbox"/>	

SFset - Possible opening releases combinations		
Release type	Combinations	
Shunt trip YO2		1
Undervoltage YM		1

SFset

Lateral disconnectable for SM6-24

Basic and options

Only one of the boxes
 - ticked
 - or filled
 by the needed value
 have to be considered
 between each
 horizontal line.

Basic lateral disconnectable SFset circuit breaker		Quantity <input type="text"/>
Rated voltage Ur	(kV)	<input type="text"/>
Service voltage	(kV)	<input type="text"/>
Impulse voltage Up	(kVbil)	<input type="text"/>
Short-circuit current Isc	(kA)	<input type="text"/>
Rated current Ir	630 A maximum	
Frequency	50 Hz <input type="checkbox"/>	60 Hz <input type="checkbox"/>
Operating mechanism position	A1 <input type="checkbox"/>	B <input type="checkbox"/> B1 <input type="checkbox"/>
Color for push buttons and indicators		
Push buttons open/close	Red/Black <input type="checkbox"/>	
Indicator open/close	Black/White <input type="checkbox"/>	
Operating mechanism charged/discharged	White/yellow <input type="checkbox"/>	

Control unit and sensors	
VIP 400	<input type="checkbox"/>
CSa4 200A	<input type="checkbox"/>
CSb4 630A	<input type="checkbox"/>

Lateral disconnectable SFset circuit breaker options								
2nd opening release (see possible combinations in the table below)								
Shunt opening release YO2	24 Vdc	<input type="checkbox"/>	60 Vdc	<input type="checkbox"/>	220 Vdc	<input type="checkbox"/>	220 Vac (50 Hz)	<input type="checkbox"/>
	30 Vdc	<input type="checkbox"/>	110 Vdc	<input type="checkbox"/>	48 Vac (50 Hz)	<input type="checkbox"/>	120 Vac (60 Hz)	<input type="checkbox"/>
	48 Vdc	<input type="checkbox"/>	125 Vdc	<input type="checkbox"/>	110 Vac (50 Hz)	<input type="checkbox"/>	240 Vac (60 Hz)	<input type="checkbox"/>
Undervoltage release YM	24 Vdc	<input type="checkbox"/>	60 Vdc	<input type="checkbox"/>	220 Vdc	<input type="checkbox"/>	220 Vac (50 Hz)	<input type="checkbox"/>
	30 Vdc	<input type="checkbox"/>	110 Vdc	<input type="checkbox"/>	48 Vac (50 Hz)	<input type="checkbox"/>	120 Vac (60 Hz)	<input type="checkbox"/>
	48 Vdc	<input type="checkbox"/>	125 Vdc	<input type="checkbox"/>	110 Vac (50 Hz)	<input type="checkbox"/>	240 Vac (60 Hz)	<input type="checkbox"/>
Remote control	Electrical motor M		24...32 Vdc	<input type="checkbox"/>	110...127 Vdc/ac	<input type="checkbox"/>		
			48...60 Vdc/ac	<input type="checkbox"/>	220...250 Vdc/ac	<input type="checkbox"/>		
	Shunt closing release YF	24 Vdc	<input type="checkbox"/>	60 Vdc	<input type="checkbox"/>	220 Vdc	<input type="checkbox"/>	220 Vac (50 Hz)
30 Vdc		<input type="checkbox"/>	110 Vdc	<input type="checkbox"/>	48 Vac (50 Hz)	<input type="checkbox"/>	120 Vac (60 Hz)	<input type="checkbox"/>
48 Vdc		<input type="checkbox"/>	125 Vdc	<input type="checkbox"/>	110 Vac (50 Hz)	<input type="checkbox"/>	240 Vac (60 Hz)	<input type="checkbox"/>
Pocket battery module					<input type="checkbox"/>			
Leaflets language		French <input type="checkbox"/>			English <input type="checkbox"/>			

SFset - Possible opening releases combinations		
Release type	Combinations	
Shunt trip YO2		1
Undervoltage YM		1

Evolis

Frontal fixed version for SM6-24
(up to 17.5 kV)

Only one of the boxes
- ticked
- or filled
by the needed value
have to be considered
between each
horizontal line.

Basic frontal fixed Evolis circuit breaker		Quantity
Rated voltage U_r (kV)	12 <input type="checkbox"/> 17.5 <input type="checkbox"/>	
Service voltage	(kV) <input type="text"/>	
Short-circuit current I_{sc}		25 kA
Rated normal current I_r (A)	630 <input type="checkbox"/> 1250 <input type="checkbox"/>	
Phase distance (mm)		185

Frontal fixed Evolis circuit breaker options			
2nd opening release (see possible combinations in the table below)			
Shunt opening release MX	24 Vac <input type="checkbox"/>	24...30 Vdc <input type="checkbox"/>	100...130 Vdc/ac <input type="checkbox"/>
	48 Vac <input type="checkbox"/>	48...60 Vdc <input type="checkbox"/>	200...250 Vdc/ac <input type="checkbox"/>
Low energy release Mitop	1 AC fault signalling SDE and reset 200...250 Vac are included <input type="checkbox"/>		
Remote control	Electrical motor MCH		
	24...30 Vdc <input type="checkbox"/>	100...125 Vdc <input type="checkbox"/>	200...250 Vdc <input type="checkbox"/>
	48...60 Vdc/ac <input type="checkbox"/>	100...130 Vac <input type="checkbox"/>	200...240 Vac <input type="checkbox"/>
Shunt closing release YF	24 Vac <input type="checkbox"/>	24...30 Vdc <input type="checkbox"/>	100...130 Vdc/ac <input type="checkbox"/>
	48 Vac <input type="checkbox"/>	48...60 Vdc <input type="checkbox"/>	200...250 Vdc/ac <input type="checkbox"/>
Operation counter CDM	<input type="checkbox"/>		
Additional auxiliary contacts OF (4 AC)	1 <input type="checkbox"/>	2 <input type="checkbox"/>	
Ready to close contact PF (1 AC)	<input type="checkbox"/>		
Locking of the circuit breaker in the open position			
By padlock	<input type="checkbox"/>		
OR by locks and keys	Tubular key type <input type="checkbox"/> Flat key type <input type="checkbox"/>		
If locks	1 lock <input type="checkbox"/>	2 identical locks <input type="checkbox"/>	2 different locks <input type="checkbox"/>
Disabling of O/C circuit breaker push buttons	<input type="checkbox"/>		

Evolis - Possible opening releases combinations		
Release type	Combinations	
Shunt trip MX		1
Low energy Mitop	1	1

Evolis

Lateral disconnectable version for SM6-24
(up to 24 kV)

Only one of the boxes
- ticked
- or filled
by the needed value
have to be considered
between each
horizontal line.

Basic lateral disconnectionable Evolis circuit breaker		Quantity <input type="text"/>
Rated voltage U_r (kV)		24
Service voltage	(kV) <input type="text"/>	
Impulse voltage U_p	(kVbil) <input type="text"/>	
Rated normal current I_r		630 A maximum
Phase distance (mm)		250
Mechanism position		B1
Color for push buttons and indicators		
Push buttons open/close	Red/Black	<input type="checkbox"/>
Indicator open/close	Black/White	<input type="checkbox"/>
Operating mechanism charged/discharged	White/yellow	<input type="checkbox"/>

Lateral disconnectable Evolis circuit breaker options

1st opening release (see possible combinations in the table below)				
Shunt opening release YO1	24 Vdc	<input type="checkbox"/>	110 Vdc <input type="checkbox"/>	
	48 Vdc	<input type="checkbox"/>	125-127 Vdc <input type="checkbox"/>	
			220 Vdc <input type="checkbox"/>	
Undervoltage release YM	24 Vdc	<input type="checkbox"/>	110 Vdc <input type="checkbox"/>	
	48 Vdc	<input type="checkbox"/>	125-127 Vdc <input type="checkbox"/>	
			220 Vdc <input type="checkbox"/>	
110 Vac (50 Hz) <input type="checkbox"/>				
220-230 Vac (50 Hz) <input type="checkbox"/>				
120 Vac (60 Hz) <input type="checkbox"/>				
110 Vac (50 Hz) <input type="checkbox"/>				
220-230 Vac (50 Hz) <input type="checkbox"/>				
120 Vac (60 Hz) <input type="checkbox"/>				
2nd opening release (see possible combinations in the table below)				
Shunt opening release YO2	24 Vdc	<input type="checkbox"/>	110 Vdc <input type="checkbox"/>	
	48 Vdc	<input type="checkbox"/>	125-127 Vdc <input type="checkbox"/>	
			220 Vdc <input type="checkbox"/>	
Undervoltage release YM	24 Vdc	<input type="checkbox"/>	110 Vdc <input type="checkbox"/>	
	48 Vdc	<input type="checkbox"/>	125-127 Vdc <input type="checkbox"/>	
			220 Vdc <input type="checkbox"/>	
110 Vac (50 Hz) <input type="checkbox"/>				
220-230 Vac (50 Hz) <input type="checkbox"/>				
120 Vac (60 Hz) <input type="checkbox"/>				
110 Vac (50 Hz) <input type="checkbox"/>				
220-230 Vac (50 Hz) <input type="checkbox"/>				
120 Vac (60 Hz) <input type="checkbox"/>				
Mitop			<input type="checkbox"/>	
Remote control	Electrical motor M	24...32 Vdc	<input type="checkbox"/>	
		48...60 Vdc/ac	<input type="checkbox"/>	
	Shunt closing release YF	24 Vdc	<input type="checkbox"/>	110 Vdc <input type="checkbox"/>
		48 Vdc	<input type="checkbox"/>	125-127 Vdc <input type="checkbox"/>
				220 Vdc <input type="checkbox"/>
				110...127 Vdc/ac <input type="checkbox"/>
		220...250 Vdc/ac <input type="checkbox"/>		
110 Vac (50 Hz) <input type="checkbox"/>				
220-230 Vac (50 Hz) <input type="checkbox"/>				
120 Vac (60 Hz) <input type="checkbox"/>				
Operation counter (already included if remote control supplied) <input type="checkbox"/>				

Evolis - Possible opening releases combinations

Release type	Combinations					
Shunt trip YO1	1		1	1	1	
Shunt trip YO2			1			
Undervoltage YM		1		1		1
Low energy Mitop				1	1	1

SM6 all-in-one

PM108534





TOOLS

schneider-electric.com

This international web site allows you to access all the Schneider Electric solutions and product information via:

- Comprehensive descriptions
- Range datasheets
- A download area
- Product selectors

You can also access information dedicated to your business and contact your Schneider Electric country support.

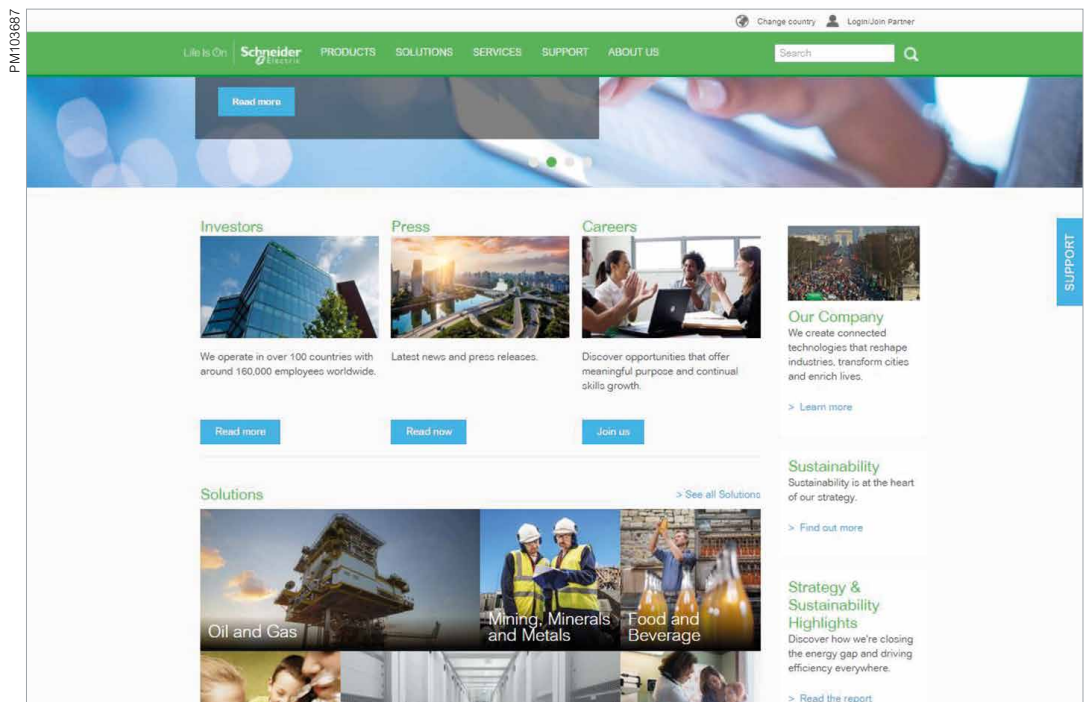



TOOLS

Web selector

This site allows you to access the Schneider Electric products in just two clicks via a comprehensive range of datasheets, with direct links to:

- Complete libraries: technical documents, catalogs, FAQs, brochures
- Selection guides from the e-catalog
- Product discovery sites and their animations

You will also find illustrated overviews, news to which you can subscribe, and a list of country contacts

Training

Training allows you to acquire the expertise (installation design, work with power on, etc.) to increase efficiency and improve customer service.

The training catalog includes beginner's courses in electrical distribution, knowledge of MV and LV switchgear, operation and maintenance of installations, and design of LV installations to give a few examples.

Schneider Electric Industries SAS

35 rue Joseph Monier
92500 Rueil-Malmaison, France
Tel : +33 (0)1 41 29 70 00

www.schneider-electric.com

15, May, 2020
AMTED398078EN

©2020 Schneider Electric SE. All rights reserved.
All Schneider Electric trademarks and service marks are the property of Schneider Electric SE, its subsidiaries and affiliated companies.

ART16044